

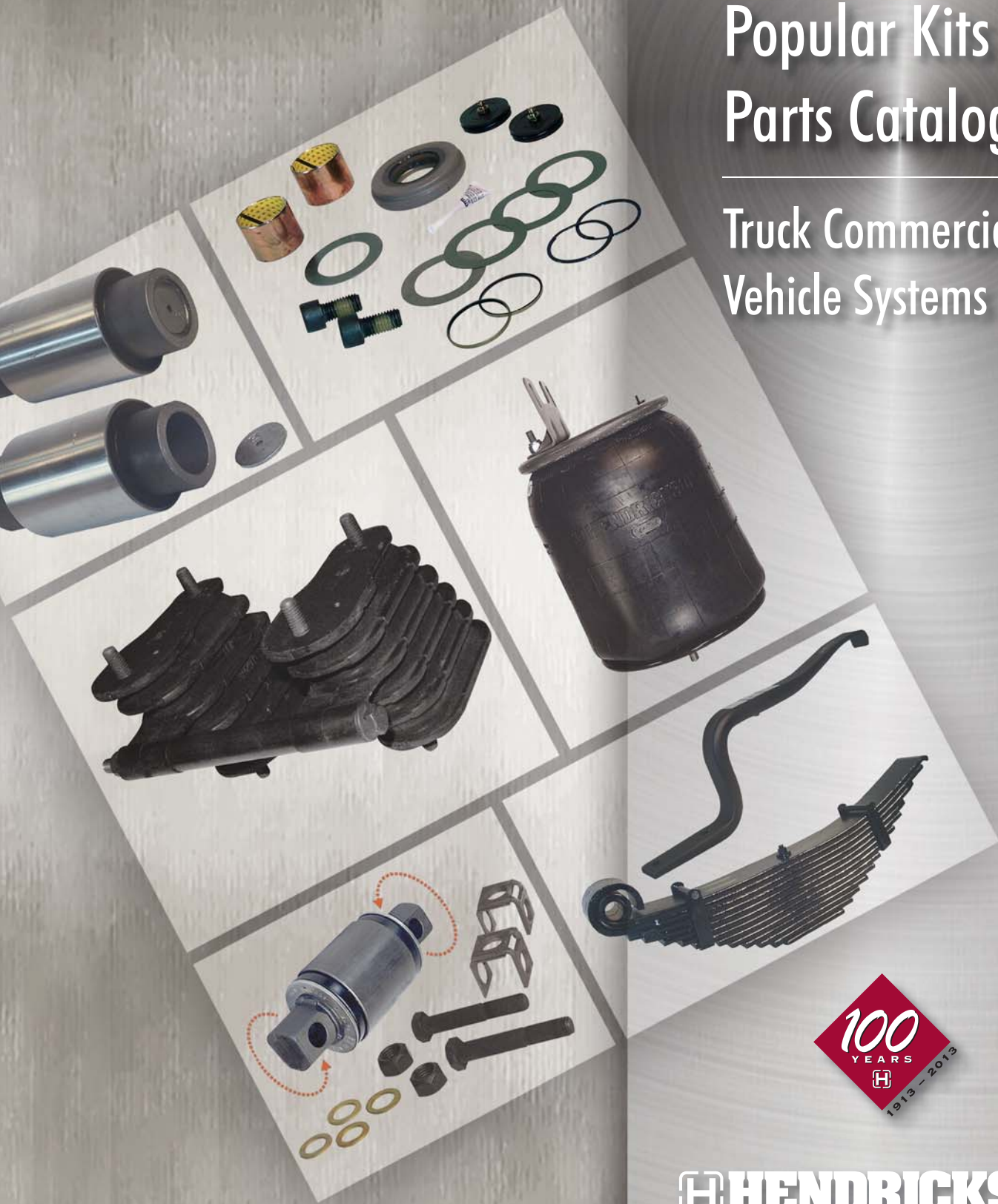

# Popular Kits and Parts Catalog

Truck Commercial  
Vehicle Systems



**HENDRICKSON**  
*The World Rides On Us®*



# Contents

## POPULAR KITS

- Auxiliary Spring Kits **5**
- Bolster Spring Kits **5**
- Equalizing Beam Bushing Kits **6**
- Height Control Valve Kits **8**
- Kingpin Bushing and Thrust Bearing Service Kits **9**
- Thrust Bearing Service Kits **10**
- QUIK-ALIGN® Collar and Pivot Bushing Kits **11**
- Slipper Pad Kits **12**
- Spring Mounting Kits **12**
- Tie Rod End Kits **13**
- Torque Rod Kits – ULTRA ROD® Two-Piece **13**

## POPULAR PARTS

- Air Springs **14**
- Cross Tubes **14**
- Equalizing Beam Bushings **15**
- Front Leaf Springs and Bushings **15**
- Height Control Valves **16**
- Load Cushions and Bushings **16**
- Main Support Members **16**
- Popular Fasteners **17**
- Shock Absorbers **17**
- Saddle Assemblies **18**
- Springs **18**
- Spring Seats **18**
- Torque Rods and Bushings **19**

## PARTS & SERVICE CONTACTS



Toll-free U.S. and Canada  
1.866.755.5968  
Outside U.S. and Canada  
1.630.910.2800



Parts Identification  
[truckparts@hendrickson-intl.com](mailto:truckparts@hendrickson-intl.com)  
Technical Support  
[techservices@hendrickson-intl.com](mailto:techservices@hendrickson-intl.com)



1.630.910.2899



Additional Hendrickson  
Product Information  
[www.hendrickson-intl.com](http://www.hendrickson-intl.com)

**FRONT STEER  
AXLE SYSTEMS**



AIRTEK®



SOFTEK®



STEERTEK NXT



IFS™



PARASTEER™

**REAR AIR  
SUSPENSIONS**



PRIMAAX® EX



COMFORT AIR®

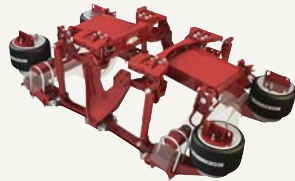

HTB® LT

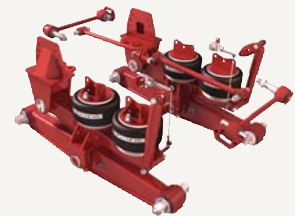

AR2™



HAS™

**WALKING BEAM  
REAR SUSPENSIONS**



HAULMAAX®



HN®

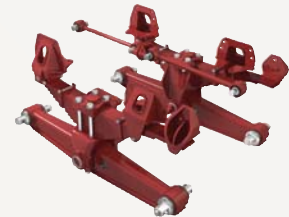

RT™/RTE™



RS™

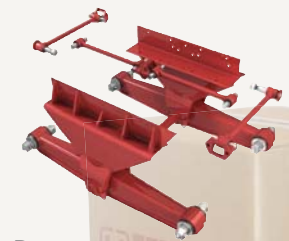

R™

**OTHER REAR  
SUSPENSIONS**



HTB® MECHANICAL



HTS™



HFS™



*Solutions at work*



**AUXILIARY SPRING KITS**

**HAULMAAX / HN**



<b>64179-004</b>	<b>Standard Spring</b>	
<b>One Set</b>		<b>Qty.</b>
60314-000	Auxiliary Spring	1
60818-002	1/2" Flange Bolt – 2.25"	3
60819-000	1/2" Flange Nut	3



<b>65902-004</b>	<b>Progressive Rate Spring</b>	
<b>One Set</b>		<b>Qty.</b>
67778-000	Progressive Rate Auxiliary Spring	1
60791-000	Auxiliary Spring Shim	2
60818-002	1/2" Flange Bolt – 2.25"	5
60819-000	1/2" Flange Nut	5

**BOLSTER SPRING KITS**

**HAULMAAX / HN**



<b>64179-048</b>	<b>HAULMAAX 40K / 46K</b>	
<b>One Set</b>		<b>Qty.</b>
	Tie-bar Bolster Springs	2
	Bolster Spring Spacer	1
	Wear Plate	1
	1/2"-13 UNC 10" Flange Bolt	1
	1/2"-13 UNC Flange Nut	9
	Tie-bar Assembly Instructions	1



<b>64179-037</b>	<b>HAULMAAX 40K / 46K</b>	
<b>One Set</b>		<b>Qty.</b>
	Tie-bar Bolster Springs	2
	Bolster Spring Spacer	1
	1/2"-13 UNC 10" Flange Bolt	1
	1/2"-13 UNC Flange Nut	9



<b>64179-002</b>	<b>HAULMAAX 40K</b>	
<b>One Set</b>		<b>Qty.</b>
	Bolster Springs	2
	1/2"-13 UNC Flange Nut	8



<b>60879-000L</b>	<b>HN 40K / 46K</b>	
<b>One Set</b>		<b>Qty.</b>
	Bolster Springs	2



## EQUALIZING BEAM BUSHING KITS

R / RS / RT / RTE

### \*Bronze Center Bushing Kits – 340-520, 650-700 Series



Kit Shown: 30437-000L

<b>30436-000L</b>	<b>340 Series</b>	
<b>Two Beams</b>		<b>Qty.</b>
30240-001	Bronze Center Bushing	2
14684-000	Beam Center Sleeve	2
30333-000	Beam Center Seal	4
32364-000	Thrust Washer	8
30087-000	Grease Fitting	2



<b>34013-054L</b>	<b>380-520 Series</b>	
<b>One Beam</b>		<b>Qty.</b>
30240-002	Bronze Center Bushing	1
14685-000	Beam Center Sleeve	1
30334-000	Beam Center Seal	2
32365-000	Thrust Washer	4
30087-000	Grease Fitting	1



<b>45374-000</b>	<b>650 Series</b>	
<b>Two Beams</b>		<b>Qty.</b>
30240-005	Bronze Center Bushing	2
25102-000	Beam Center Sleeve	2
31577-000	Beam Center Seal	4
45261-000	Thrust Washer	4
30087-000	Grease Fitting	2

<b>30437-000L</b>	<b>380-520 Series</b>	
<b>Two Beams</b>		<b>Qty.</b>
30240-002	Bronze Center Bushing	2
14685-000	Beam Center Sleeve	2
30334-000	Beam Center Seal	4
32365-000	Thrust Washer	8
30087-000	Grease Fitting	2

### \*Bronze Center Bushing Kits – T Series: Hollow / Solid Sleeves

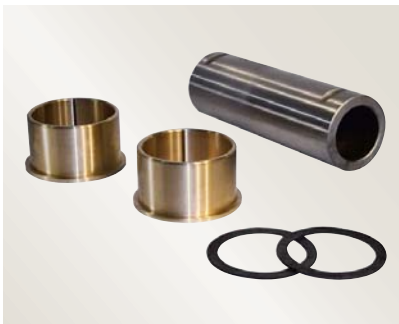

<b>34013-079</b>	<b>T 600 Series</b>	
<b>One Beam</b>		<b>Qty.</b>
• 4" I.D. Bushing ¼" Lip - Hollow Sleeve		
03415-000	Bronze Center Bushing	2
03418-000	Beam Center Sleeve	1
03416-000	Thrust Washer	2

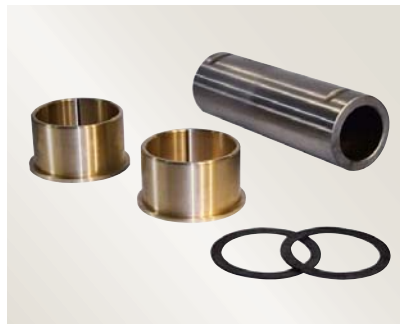

<b>34013-081</b>	<b>T 900 Series</b>	
<b>One Beam</b>		<b>Qty.</b>
• 4" I.D. Bushing ½" Lip - Hollow Sleeve		
08904-000	Bronze Center Bushing	2
03418-000	Beam Center Sleeve	1
03416-000	Thrust Washer	2

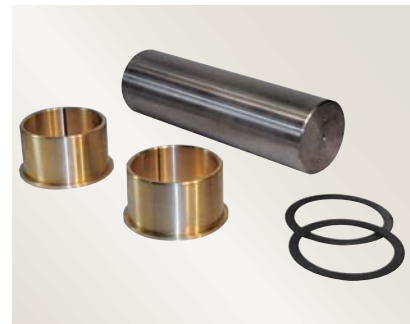

Kit Shown: 34013-078

<b>34013-078</b>	<b>T 600 Series</b>	
<b>One Beam</b>		<b>Qty.</b>
• 4" I.D. Bushing ¼" Lip - Solid Sleeve		
03415-000	Bronze Center Bushing	2
10358-000	Beam Center Pin	1
03416-000	Thrust Washer	2

<b>34013-080</b>	<b>T 900 Series</b>	
<b>One Beam</b>		<b>Qty.</b>
• 4" I.D. Bushing ½" Lip - Solid Sleeve		
08904-000	Bronze Center Bushing	2
10358-000	Beam Center Pin	1
03416-000	Thrust Washer	2

\* See Equalizing Beam and Components Selection Guide No. 45745-147 for more information



## EQUALIZING BEAM BUSHING KITS (CONT.)

### AR2 / R / RS / RT / RTE

■ \*Rubber End Bushing and Adapter Kits – 340-520, 650-850, 1000-1200 Series



Kit Shown: 34013-049L

#### **34013-049L** 440 Series One Wheel End Qty.

45900-000	End Bushing	1
45000-007L	End Bushing Adapter Kit	1

#### **34013-050L** 480-520 Series One Wheel End Qty.

29878-001	End Bushing	1
21140-034L	End Bushing Adapter Kit	1

#### **34013-048L** 340 Series One Wheel End Qty.

06969-000	End Bushing	1
45000-013L	End Bushing Adapter Kit	1

#### **34013-073L** 460 Series One Wheel End Qty.

45900-000	End Bushing	1
21140-034L	End Bushing Adapter Kit	1

#### **34013-051L** 520 Series One Wheel End Qty.

45407-000	End Bushing	1
21140-033L	End Bushing Adapter Kit	1



Kit Shown: 45000-007L

#### **45000-007L** 440 Series One Wheel End Qty.

21867-023	3/4"-16 UNF Bolt – 6.5"	1
22962-001	3/4" Hardened Washer	2
30191-000	3/4"-16 UNF Locknut	1
45163-000	Beam End Adapter	2
45289-002	Adapter Tube	1

#### **21140-034L** 460 Series One Wheel End Qty.

30550-008	1"- Top Pad Bolt – 10.5"	1
22962-008	1" Hardened Washer	2
08017-000	1"-14 UNS Locknut	1
45871-000	Beam End Adapter	2
45289-004	Adapter Tube	1

#### **45000-013L** 340 Series One Wheel End Qty.

21867-007	3/4"-16 UNF Bolt – 6.0"	1
22962-001	3/4" Hardened Washer	2
30191-000	3/4"-16 UNF Locknut	1
45163-000	Beam End Adapter	2
45289-001	Adapter Tube	1

#### **21140-033L** 520 Series One Wheel End Qty.

30550-010	1"- Top Pad Bolt – 11.0"	1
22962-000	1" Hardened Washer	2
08017-000	1"-14 UNS Locknut	1
45871-000	Beam End Adapter	2
45289-002	Adapter Tube	1



Kit Shown: 21140-007

#### **21140-007** 650 Series One Wheel End Qty.

17491-022	1 7/8"-12 UNF Slotted Nut	2
17800-003	Cotter Pin	2
22057-000	Beam End Adapter	2
21592-003	Beam End Shaft	1

#### **21140-004** 850 Series One Wheel End Qty.

17491-022	1 7/8"-12 UNF Slotted Nut	2
17800-003	Cotter Pin	2
21592-001	Beam End Adapter	2
21593-000	Beam End Shaft	1
45456-000	Thrust Washer	1

#### **21140-024** 1000/1200 Series One Wheel End with Adapter Tube Qty.

17491-022	1 7/8"-12 UNF Slotted Nut	2
17800-003	Cotter Pin	2
21594-000	Beam End Adapter	2
21592-002	Beam End Shaft	1
45425-000	Adapter Tube	1
45456-000	Thrust Washer	1

#### **21140-042** 1000/1200 Series One Wheel End with Tube and Nut Qty.

46558-001	Beam End Shaft	1
46493-000	Beam Hanger Tube	1
46492-000	2"-12 UNF Hex Nut	1
45457-000	2"-12 UNF Locknut	1
46556-000	Hardened Washer	2

\* See Equalizing Beam and Components Selection Guide No. 45745-147 for more information



**EQUALIZING BEAM BUSHING KITS (CONT.)**

**AR2 / HAULMAAX / HN / R / RS / RT / RTE**

**■ Bar Pin End Bushing Kits – 340-520 Series**



**34013-088L**  
**One Beam End**

	Qty.
1"-8 UNC Hex Bolt – 6.0"	2
1" Hardened Washer	4
1"-8 UNC Locknut	2
Bar Pin Shim 0.25" x 0.12"	2
Bar Pin End Bushing (Shim)	1

**With Shims**

**34013-188L**  
**One Beam End**

	Qty.
1"-8 UNC Hex Bolt – 6.0"	2
1" Hardened Washer	4
1"-8 UNC Locknut	2
Bar Pin Shim 0.25" x 0.12"	2
Bar Pin End Rotating Bushing (Shim)	1

**With Shims**

**34013-087L**  
**One Beam End**

	Qty.
1"-8 UNC Hex Bolt – 6.0"	2
1" Hardened Washer	4
1"-8 UNC Locknut	2
Bar Pin End Bushing (Non Shim)	1

**Non-Shim**

**HEIGHT CONTROL VALVE KITS**

**AR2 / COMFORT AIR / HAS / PARASTEER / PRIMAAX / PRIMAAX EX**



Kit Shown: 57977-000

**57977-000**  
**One Side**

	Qty.
HCV Integrated Dump Valve	1
HCV Mounting Bracket	1
¼" Hardened Washer	2
¼"-20 UNC Locknut	2

**Dump Valve**

**60826-000**  
**One Side**

	Qty.
Height Control Valve	1
HCV Mounting Bracket	1
¼" Flat Washer	2
¼"-20 UNC Locknut	2
Locating Pin	1

**Non-Dump Valve**

**59013-000**  
**One Side**

	Qty.
Height Control Valve	1
¼" Hardened Washer	2
¼"-20 UNC Locknut	2

**Dump Valve**

**NOTE:** Universal valve replaces both the 50433-001 and 50433-002.





## KINGPIN BUSHING AND THRUST BEARING SERVICE KITS

### AIRTEK / IFS / SOFTEK / STEERTEK / STEERTEK NXT

#### ■ STEERTEK NXT Axle Kits



#### 60961-629

##### NXT One Wheel End – LH

		Qty.
68687-003	Grease Cap Assembly, Upper	1
68687-002	Grease Cap Assembly, Lower	1
58909-001	Kingpin Bushing	2
59828-000	Composite Thrust Bearing	1
68731-000	Kingpin Seal	2
60236-001	5/8"-11 UNC Socket Head Cap Screw	2
60937-000	Loctite Tube	1
33117-000	Grease Zerk	1



#### 60961-630

##### NXT One Wheel End – RH

		Qty.
68687-003	Grease Cap Assembly, Upper	1
68687-002	Grease Cap Assembly, Lower	1
58909-001	Kingpin Bushing	2
64256-000	Roller Thrust Bearing	1
68731-000	Kingpin Seal	2
60236-001	5/8"-11 UNC Socket Head Cap Screw	2
60937-000	Loctite Tube	1
33117-000	Grease Zerk	1



#### 60961-628

##### NXT Axle Set

		Qty.
68687-003	Grease Cap Assembly, Upper	2
68687-002	Grease Cap Assembly, Lower	2
58909-001	Kingpin Bushing	4
59828-000	LH Composite Thrust Bearing	1
64256-000	RH Roller Thrust Bearing	1
68731-000	Kingpin Seal	4
60236-001	5/8"-11 UNC Socket Head Cap Screw	4
60937-000	Loctite Tube	1
33117-000	Grease Zerk	2

#### ■ STEERTEK Axle / IFS Kits



#### 60961-009

##### One Wheel End – LH

		Qty.
59156-000	Grease Cap Assembly	2
58937-000	Retaining Ring	2
58909-000	Kingpin Bushing	2
59828-000	Composite Thrust Bearing	1
60236-001	5/8"-11 UNC Socket Head Cap Screw	2
58910-001	Kingpin Seal	2
60259-001	Kingpin Shim 0.005"	4
60259-002	Kingpin Shim 0.047"	1
60937-000	Loctite Tube	1



#### 60961-039

##### One Wheel End – RH

		Qty.
59156-000	Grease Cap Assembly	2
58937-000	Retaining Ring	2
58909-000	Kingpin Bushing	2
64256-000	Roller Thrust Bearing	1
60236-001	5/8"-11 UNC Socket Head Cap Screw	2
58910-001	Kingpin Seal	2
60259-001	Kingpin Shim 0.005"	4
60259-002	Kingpin Shim 0.047"	1
60937-000	Loctite Tube	1



#### 60961-040

##### Axle Set

		Qty.
59156-000	Grease Cap Assembly	4
58937-000	Retaining Ring	4
58909-000	Kingpin Bushing	4
59828-000	Composite Thrust Bearing	1
64256-000	Roller Thrust Bearing	1
60236-001	5/8"-11 UNC Socket Head Cap Screw	4
58910-001	Kingpin Seal	4
60259-001	Kingpin Shim 0.005"	8
60259-002	Kingpin Shim 0.047"	2
60937-000	Loctite Tube	1



## THRUST BEARING SERVICE KITS

### AIRTEK / IFS / SOFTEK / STEERTEK / STEERTEK NXT

#### STEERTEK NXT Kits

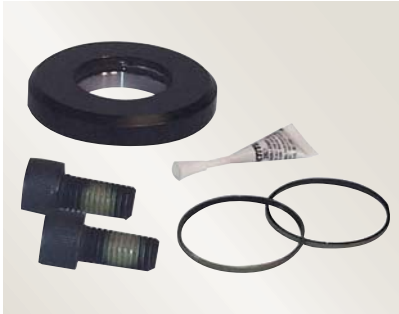

#### 60961-631

##### NXT One Wheel End – LH

		Qty.
59828-000	Composite Thrust Bearing	1
60236-001	5/8"-11 UNC Socket Head Cap Screw	2
68731-000	Kingpin Seal	2
60937-000	Loctite Tube	1



#### 60961-632

##### NXT One Wheel End – RH

		Qty.
64256-000	Roller Thrust Bearing	1
60236-001	5/8"-11 UNC Socket Head Cap Screw	2
68731-000	Kingpin Seal	2
60937-000	Loctite Tube	1



#### 60961-633

##### NXT Axle Set

		Qty.
59828-000	Composite Thrust Bearing	1
64256-000	Roller Thrust Bearing	1
60236-001	5/8"-11 UNC Socket Head Cap Screw	4
68731-000	Kingpin Seal	4
60937-000	Loctite Tube	1

#### STEERTEK / IFS Kits



#### 60961-041

##### One Wheel End – LH

		Qty.
59828-000	Composite Thrust Bearing	1
60236-001	5/8"-11 UNC Socket Head Cap Screw	2
58910-000	Kingpin Seal	2
60259-001	Kingpin Shim 0.005"	4
60259-002	Kingpin Shim 0.047"	1
60937-000	Loctite Tube	1



#### 60961-042

##### One Wheel End – RH

		Qty.
64256-000	Roller Thrust Bearing	1
60236-001	5/8"-11 UNC Socket Head Cap Screw	2
58910-000	Kingpin Seal	2
60259-001	Kingpin Shim 0.005"	4
60259-002	Kingpin Shim 0.047"	1
60937-000	Loctite Tube	1



#### 60961-043

##### Axle Set

		Qty.
59828-000	Composite Thrust Bearing	1
64256-000	Roller Thrust Bearing	1
60236-001	5/8"-11 UNC Socket Head Cap Screw	4
58910-000	Kingpin Seal	4
60259-001	Kingpin Shim 0.005"	8
60259-002	Kingpin Shim 0.047"	2
60937-000	Loctite Tube	1



## QUIK-ALIGN® COLLAR AND PIVOT BUSHING KITS

### AL405 / COMFORT AIR / FIREMAAX EX / MAXAIR / PRIMAAX EX

Popular Kits



<b>60632-001</b>	<b>COMFORT AIR</b>	
<b>Axle Set</b>		<b>Qty.</b>
64632-000	Eccentric Collar	1
64633-000	Concentric Collar	3
64107-000	1"-8 UNC Bolt – 7.5"	2
22962-035	1" Hardened Washer	4
64108-000	1"-8 UNC Locknut	2



<b>60683-001</b>	<b>MACK-AL405/MAXAIR</b>	
<b>Tandem Set</b>		<b>Qty.</b>
60496-000	Eccentric Collar	2
60497-000	Concentric Collar	6
58705-003	7/8"-8 UNC Bolt – 7.5"	4
22962-034	7/8" Hardened Washer	8
60266-000	7/8"-8 UNC Locknut	4
58648-000	Pivot Bushing	4



<b>60632-020</b>	<b>*PAX EX/FMX EX/PAX/FMX</b>	
<b>Axle Set</b>		<b>Qty.</b>
64632-000	Eccentric Collar	2
64633-000	Concentric Collar	2
68217-000	1"-14 UNF Bolt – 7.5"	2
68232-000	1" Hardened Washer	4
68218-000	1"-14 UNF Locknut	2
58648-000	Pivot Bushing	2



<b>60632-021</b>	<b>*PAX EX/FMX EX/PAX/FMX</b>	
<b>Axle Set</b>		<b>Qty.</b>
64632-000	Eccentric Collar	2
64633-000	Concentric Collar	2
68217-000	1"-14 UNF Bolt – 7.5"	2
68232-000	1" Hardened Washer	4
68218-000	1"-14 UNF Locknut	2



<b>60682-001</b>	<b>MACK-AL405/MAXAIR</b>	
<b>One Wheel End</b>		<b>Qty.</b>
60662-000	Eccentric Collar	1
60661-000	Concentric Collar	1
58705-003	7/8"-8 UNC Bolt – 7.5"	1
22962-034	7/8" Hardened Washer	2
60266-000	7/8"-8 UNC Locknut	1
58648-000	Pivot Bushing	1



<b>34013-103</b>	<b>**COMFORT AIR</b>	
<b>One Wheel End</b>		<b>Qty.</b>
64107-000	1"-8 UNC Bolt – 7.5"	1
22962-035	1" Hardened Washer	2
64108-000	1"-8 UNC Locknut	1
58648-000	Pivot Bushing	1
64817-000	Plastic Isolator Puck	2



<b>60632-019</b>	<b>*PAX EX/FMX EX/PAX/FMX</b>	
<b>One Wheel End</b>		<b>Qty.</b>
64632-000	Eccentric Collar	1
64633-000	Concentric Collar	1
68217-000	1"-14 UNF Bolt – 7.5"	1
68232-000	1" Hardened Washer	2
68218-000	1"-14 UNF Locknut	1



<b>60632-018</b>	<b>*PAX EX/FMX EX/PAX/FMX</b>	
<b>One Wheel End</b>		<b>Qty.</b>
68217-000	1"-14 UNF Bolt – 7.5"	1
68232-000	1" Hardened Washer	2
68218-000	1"-14 UNF Locknut	1

\* PRIMAAX EX / FIREMAAX EX / PRIMAAX / FIREMAAX — All models / capacities  
 \*\* Not used for Hino Vehicles



**SLIPPER PAD KITS**

**HAS / HA**

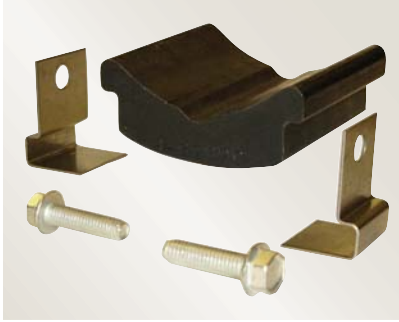

Kit Shown: 56557-004

**56557-001**

**One Hanger**

56908-000	HA Slipper Pad	1	<b>HA</b>
50597-000	HAS Retainer Plate	2	<b>Qty.</b>
57306-000	3/8" Rolok Screw – 1.5"	4	

**56557-002**

**One Hanger**

50612-000	HAS Slipper Pad	1	<b>HA/HAS</b>
50597-000	HAS Retainer Plate	2	<b>Qty.</b>
57306-000	3/8" Rolok Screw – 1.5"	4	

**HA**  
**Qty.**

**56557-004**

**One Hanger**

56929-000	HAS Slipper Pad	1	<b>HAS</b>
57566-000	HAS Retainer Clip	2	<b>Qty.</b>
57306-000	3/8" Rolok Screw – 1.5"	2	

**56557-005**

**One Hanger**

56929-000	HAS Slipper Pad	1	<b>HAS</b>
58287-001	Slipper Pad Lock Pin – 1"	2	<b>Qty.</b>

**HAS**  
**Qty.**

**HAS**  
**Qty.**

**SPRING MOUNTING KITS**

**RT / RTE**



Kit Shown: 29828-034L



**29828-023**

**One Wheel End**

00194-000	Rebound Bolt Spacer	1	<b>Qty.</b>
24531-005	1/2"-13 UNC Bolt – 6.5"	1	
49846-000	1/2"-13 UNC Locknut	1	

**29828-034L**

**Vehicle Set**

00194-000	Rebound Bolt Spacer	2	<b>Qty.</b>
24531-005	1/2"-13 UNC Bolt – 6.5"	2	
24531-009	1/2"-13 UNC Bolt – 4.0"	4	
22962-011	1/2" Hardened Washer	8	
49846-000	1/2"-13 UNC Locknut	6	
43146-000	Spring Hanger Pin	2	
33117-000	Grease Zerk	2	

**00062-001L**

**One Hanger**

00062-000	Spring Hanger Drawkey	1	<b>Qty.</b>
17341-000	1/2" Lockwasher	1	
17351-000	1/2"-13 UNC Hex Nut	1	

**29828-035L**

**One Wheel End**

24531-009	1/2"-13 UNC Bolt – 4.0"	2	<b>Qty.</b>
22962-011	1/2" Hardened Washer	4	
49846-000	1/2"-13 UNC Locknut	2	



## \*TIE ROD END KITS

### AIRTEK / SOFTEK / STEERTEK / STEERTEK NXT



Kit Shown: 60961-010

#### 60961-010

Straight Tie Rods – 69 KPI, 4.25" Drop

##### Axle Set

		Qty.
64000-001	LH Tie Rod End	1
64000-002	RH Tie Rod End	1
22962-007	7/8" Hardened Washer	2
17800-004	Cotter Pin	2

#### 60961-011

Straight Tie Rods – 70.9 KPI, 4.25" Drop

##### Axle Set

		Qty.
64002-001	LH Tie Rod End	1
64002-002	RH Tie Rod End	1
22962-007	7/8" Hardened Washer	2
17800-004	Cotter Pin	2

#### 60961-082

Straight Tie Rods – 70.9 KPI, 4.25" Drop

##### Axle Set

		Qty.
65034-001	LH Tie Rod End	1
65034-002	RH Tie Rod End	1
22962-007	7/8" Hardened Washer	2
17800-004	Cotter Pin	2



Kit Shown: 60961-085

#### 60961-085

Straight Tie Rods – 70.9 KPI, 4.25" Drop

##### Left Hand

		Qty.
65034-001	Tie Rod End	1
22962-007	7/8" Hardened Washer	1
17800-004	Cotter Pin	1

##### Right Hand

		Qty.
65034-002	Tie Rod End	1
22962-007	7/8" Hardened Washer	1
17800-004	Cotter Pin	1

#### 60961-025

Straight Tie Rods – 69 KPI, 4.25" Drop

##### Left Hand

		Qty.
64000-001	Tie Rod End	1
22962-007	7/8" Hardened Washer	1
17800-004	Cotter Pin	1

##### Right Hand

		Qty.
64000-002	Tie Rod End	1
22962-007	7/8" Hardened Washer	1
17800-004	Cotter Pin	1



Kit Shown: 60961-137

#### 60961-137

Drop Tie Rods – 69/70.9 KPI, 5.36" Drop

##### Left Hand

		Qty.
66645-001	Tie Rod End	1
22962-007	7/8" Hardened Washer	1
17800-004	Cotter Pin	1

##### Right Hand

		Qty.
66645-002	Tie Rod End	1
22962-007	7/8" Hardened Washer	1
17800-004	Cotter Pin	1

#### 60961-139

Drop Tie Rods – 69/70.9 KPI, 5.36" Drop

##### Axle Set

		Qty.
66645-001	LH Tie Rod End	1
66645-002	RH Tie Rod End	1
22962-007	7/8" Hardened Washer	2
17800-004	Cotter Pin	2

\* See Hendrickson Technical Bulletin No. SEU-0223 for more information on tie rod ends.

## TORQUE ROD KITS – ULTRA ROD® TWO-PIECE

### AR2 / COMFORT AIR / HAS / HAULMAX / HN / PRIMAAX EX / R / RS / RT / RTE

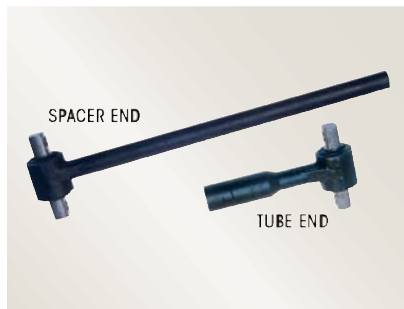

#### 60218-000

		Qty.
66610-000	Tube End, 5/8" Hole Dia. 47691-000H Bushing	1
66661-000	Spacer End, 5/8" Hole Dia. 47691-000H Bushing	1

#### 60215-000

		Qty.
66610-000	Tube End, 5/8" Hole Dia. 47691-000H Bushing	1
66681-000	3" Taper End 64697-000H Bushing	1

#### 60223-000

		Qty.
66610-000	Tube End, 5/8" Hole Dia. 47691-000H Bushing	1
66660-000	Spacer End, 5/8" Hole Dia. 47691-000H Bushing	1

#### 60220-000

		Qty.
66610-000	Tube End, 5/8" Hole Dia. 47691-000H Bushing	1
66691-000	1 7/8" Taper End 66735-000H Bushing	1



## AIR SPRINGS

### AIRTEK / AL405 / COMFORT AIR / HA / HAS / PRIMAAX



Part Shown: 66349-002L

Part No.	Front Model
65790-002L	AIRTEK - Spartan Motorhome Chassis 12.6K/14.6K
66349-002L	AIRTEK - Volvo, Mack, Spartan Motorhome Chassis 10.5/12.5K
69116-002	AIRTEK - Freightliner, Western Star, Sterling



Part No.	Front Model
60716-002L	AIRTEK - Volvo, Mack 13.2/14.6K



Part Shown: 50405-002L

Part No.	Rear Model
50405-002L	HA
50898-002L	HAS 40LH
50899-002L	HAS for Mack
57122-002L	HAS
58520-002L	HAS
60271-002L	PRIMAAX
60929-002	COMFORT AIR
64651-002L	HAS for Mack
64917-002L	AL405
67043-002L	PRIMAAX EX



Part No.	Rear Model
58786-002	AL405 / MAXAIR

## CROSS TUBES

### HA / R / RS / RT / RTE

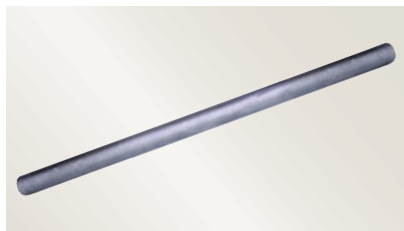

Part Shown: 44643-009L

Part No.	REAR Model	Length
44642-022	HA 360-460, RT/RTE 340	36½"
44643-009L	R/RS/RT 343-503 Series	44⅞"
44642-008L	340 Series	44⅞"
10397-014	650 Series	40¾"
07622-003	523 Series	46"



## EQUALIZING BEAM BUSHINGS

### AR2 / R / RS / RT / RTE

#### ■ Rubber Center Bushings 340 – 650 Series

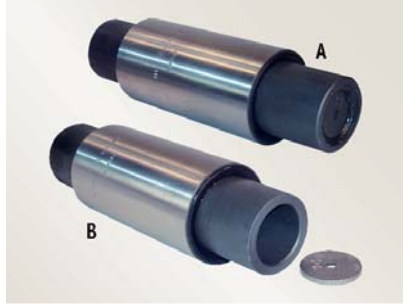

##### 340 Series

A: 06664-000L  
B: 22279-000L – loose plug



##### 400 Series

E: 49400-000L High Confinement  
F: 49600-000L High Confinement – loose plug



##### 380 Series

C: 05919-000L  
D: 22282-000L – loose plug

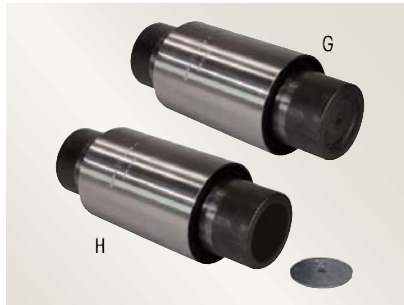

##### 380-523 Series

G: 29483-005L  
H: 34013-097L – loose plug

##### 650 Series

10366-000L

#### ■ Rubber End Bushings



Part Shown: 45900-000L

Part No.	Model	Length
06966-000L	280 Series	4½"
06969-000L	340 Series	5¼"
45900-000L	460 Series	5¾"
29878-001L	480-520 Series	5¾"
45407-000L	520 Series	6"
10363-000L	650 Series	6"
10364-000	850 Series	7"

Popular Parts

## FRONT LEAF SPRINGS AND BUSHINGS

### AIRTEK / SOFTEK



Part Shown: 59930-021

Part No.	Model
59930-021	AIRTEK - Freightliner, Western Star
64772-000	AIRTEK - Volvo, Mack
66420-000	AIRTEK - International Truck Vehicles
66626-001	SOFTEK - Blue Bird All American Buses, 14.6K

#### ■ Spring Eye Bushings



Part No.	Model
59259-002	AIRTEK w/STEEERTEK Axle- Freightliner, Western Star, Sterling



## HEIGHT CONTROL VALVES

### AIRTEK / HAS / AL405 / MAXAIR

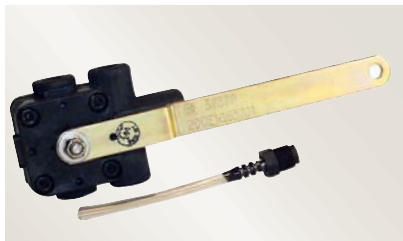

Part Shown: 59899-000

Part No.	Model
59899-000	HAS, AL405 / Maxair
59935-013	AIRTEK - LH Freightliner, Western Star, Sterling
59935-002	AIRTEK - RH Freightliner, Western Star, Sterling

Part No.	Model
60501-000	AIRTEK - Blue Bird Bus 14.6K, COMFORT AIR, HTB 210, PARASTEER, HAS Integrated Dump Valve
64089-000L	AIRTEK - Volvo, Mack

## LOAD CUSHIONS AND BUSHINGS

### RS SERIES



Part Shown: 26953-000L

Part No.	Model
48973-000L	340/400 Series
26953-000L	460/520 Series



Part No.	Model
24209-000	Center Load Cushion

### Vertical Drive Bushing



RS Series
19279-000L

## MAIN SUPPORT MEMBERS

### HAS / HA / AL405 / MAXAIR



Part Shown: 56946-000

Part No.	REAR Model	Thickness
56946-000	HAS 230/402/460	2.00"
56943-000	HAS 210/400	1.88"
57217-000	HAS 40LH	1.75"
56940-000	HAS 190/360	1.75"
56871-001	HA 400	1.88"
48645-001	HA 460	2.38"



Part Shown: 58691-000

Part No.	REAR Model
58691-000	AL405 / MAXAIR - LH
58768-000	AL405 / MAXAIR - RH





## POPULAR FASTENERS



**Part No.** 48574-000  
**Description** Spherical Washer



Part Shown: 22962-002

**Part No.** 22962-002  
**Description** 7/8" Hardened Washer

**Part No.** 22962-006  
**Description** 1" Hardened Washer



**Part No.** 06696-000  
**Description** 7/8"-14 UNF Saddle Cap Stud

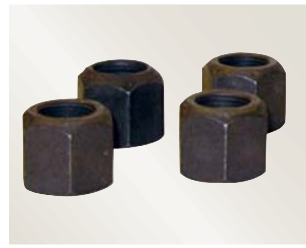

**Part No.** 08017-000  
**Description** 1"-14 UNS Locknut

## SHOCK ABSORBERS

### AIRTEK / COMFORT AIR / HAS / HAULMAAX / HN / HTB 400LT / PRIMAAX EX



Part Shown: 58913-003L

**Part No.** 58913-003L  
**Front Model** AIRTEK - Freightliner, Western Star, Sterling

64838-002L AIRTEK w/STEEERTEK Axle—  
Volvo 12/12.5K, 13.2/14.6K  
Mack 12/12.5K, 13.2/14.6K

64838-003L AIRTEK w/STEEERTEK NXT Axle—  
Volvo 12/12.5K, 13.2/14.6K  
Mack 12/12.5K, 13.2/14.6K

65992-001 AIRTEK - International Truck  
Vehicles



Part Shown: 60685-001L

**Part No.** 60657-003  
**Rear Model** PRIMAAX EX / FIREMAAX EX /  
PRIMAAX / FIREMAAX

60657-005 8½", 10" Ride Height

60657-005 Kenworth Tridem

60657-007 Volvo

60665-011 12½", 14¾", 15½" Ride Height,  
232T/462T/692T/262S/522S

60657-008 HTB 400LT  
HAS

60670-003L 150L

60670-005L 190/210/230/  
360/400/402/460

60670-006L 210/230/400/402/460  
Volvo/Mack

60670-007L 400/402/460  
Inboard Standard

60670-008L 190L/210L/230L/  
400L/402L/460L

HAS HI-TORQUE™

60675-001L 190/230/400/460 - Volvo/Mack

60675-003L 190/210/230

60675-005L 400/460

60675-006L 400/402/460 - Inboard

60685-001L 40LH

60998-003 COMFORT AIR



Part Shown: 60680-003L

**Part No.** 57241-006L  
**Rear Model** AL405

60680-003L HN

60680-004L HAULMAAX 16.5" Saddle Ht.

60680-005L HAULMAAX 17.5"/18.5" Saddle Ht.

Popular Parts



## SADDLE ASSEMBLIES



### RT / RTE SERIES

Part No.	Model	Height
31017-022L	343/400/403	6"
31017-109L	403	7 <sup>3</sup> / <sub>8</sub> "
31017-096L	460/463	6"
31017-110L	460/463	7 <sup>3</sup> / <sub>8</sub> "
31017-053	523 – RT Only	6"
31017-077	523	7 <sup>3</sup> / <sub>8</sub> "
31017-004	650	7 <sup>1</sup> / <sub>8</sub> "

Part Shown: 31017-096L

## SPRINGS

### RT / RTE



Part Shown: 47057-000

Part No.	Model
45027-000	RT 400/403
47057-000	RT 460/463/480/503/ 520/523
02056-000	RT 650



Part Shown: 45322-000

Part No.	Model
45121-000	RTE 400/403
45322-000	RTE 460/463/480/503

### Spring Hanger Pins

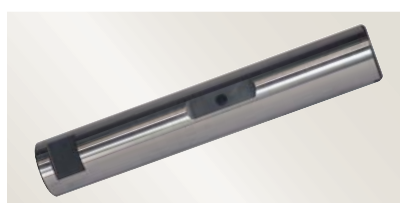

Part Shown: 32276-000

Part No.	Model	Dia.
32276-000	Use with Draw Key 00062-001	1 <sup>1</sup> / <sub>4</sub> "
32277-000	Use with Draw Key 00062-001	1 <sup>3</sup> / <sub>8</sub> "
43146-000L	Double Lock Style Hanger	1 <sup>3</sup> / <sub>8</sub> "
00005-000	Use with Draw Key 00081-001	1 <sup>1</sup> / <sub>2</sub> "
45797-000	Double Lock Style Hanger	1 <sup>1</sup> / <sub>2</sub> "

### Spring Eye Bushings



Part Shown: 30057-007L

Part No.	Model	I.D.
30057-007L	340 Series	1 <sup>1</sup> / <sub>4</sub> "
30057-008L	400–520 Series	1 <sup>3</sup> / <sub>8</sub> "
22285-000	650 Series	1 <sup>1</sup> / <sub>2</sub> "

## SPRING SEATS



Part Shown: 56563-000

### AL405 / \*HA / \*HAS SERIES

Part No.	Model
56563-000	AL405 for Mack-6" RHF/RHR
56562-000	AL405 for Mack-6" LHF/LHR

\* Refer to Parts List Lit. No. SP-149 for HAS and SP-179 for HA Spring Seats.



**\*TORQUE RODS**

**ULTRA ROD® TWO-PIECE TORQUE RODS**



**Spacer End – Straddle**

Part No.	Length	Bushing
66661-000H	27"	47691-000H
66660-000H	35"	47691-000H

**Tube End – Straddle**

Part No.	Bushing
66610-000H	47691-000H



**Spacer End – Taper Pin**

Part No.	Length	Bushing
66681-000H	27"	64697-000H
66691-000H	27"	66735-000H
66671-000H	27"	64809-000H
66680-000H	35"	64697-000H
66690-000H	35"	66735-000H
66670-000H	35"	64809-000H

**ONE-PIECE TORQUE RODS**



Part No.	Length	Bushing
62007-365	14 <sup>3</sup> / <sub>8</sub> "	47691-000H
49681-001	14 <sup>7</sup> / <sub>8</sub> "	47691-000H
57950-007	14 <sup>7</sup> / <sub>8</sub> "	47691-000H
58757-005	21 <sup>1</sup> / <sub>2</sub> "	47691-000H
58757-006	22"	47691-000H
62000-565	22 <sup>1</sup> / <sub>4</sub> "	47691-000H
62700-570	22 <sup>7</sup> / <sub>8</sub> "	69210-000H
58757-615	24 <sup>1</sup> / <sub>4</sub> "	47691-000H

**ULTRA ROD® PLUS™ TWO-PIECE TORQUE RODS**



**Spacer End – Straddle**

Part No.	Length	Bushing
46661-001	30"	64400-002
46681-001	30"	64400-004

**Tube End – Straddle**

Part No.	Bushing
46610-001	64400-002



**\*\*Spacer End**

Part No.	Length	I.D.
64474-000	30"	2 <sup>3</sup> / <sub>4</sub> "

**\*\*Tube End**

Part No.	I.D.
64473-000	2 <sup>3</sup> / <sub>4</sub> "

\* See Torque Rod Selection Guide Literature No. 45745-148 for information on bushing use and configurations.

\*\* Empty end hubs, add bushing to achieve desired configuration.

**TORQUE RODS BUSHINGS**



Part Shown: 47691-000L

Part No.	Type	Bushing O.D.	Hole Dia.	Mtg. Ctrs.
47691-000L	Straddle	2"	5/8"	4"
64400-002L	Straddle	3/4"	5/8"	4"



Part Shown: 44695-000L

Part No.	Type	Bushing O.D.	Hole Dia.	Mtg. Ctrs.
44694-000L	Straddle	2 <sup>1</sup> / <sub>2</sub> "	5/8"	4 <sup>3</sup> / <sub>8</sub> "
44695-000L	Straddle	2 <sup>3</sup> / <sub>4</sub> "	5/8"	4 <sup>3</sup> / <sub>8</sub> "
49210-000L	Straddle	2 <sup>3</sup> / <sub>4</sub> "	3/4"	4 <sup>3</sup> / <sub>8</sub> "
57256-000L	Straddle	2 <sup>1</sup> / <sub>2</sub> "	5/8"	4 <sup>3</sup> / <sub>8</sub> "
48304-000L	Straddle	3 <sup>1</sup> / <sub>2</sub> "	7/8"	5 <sup>1</sup> / <sub>4</sub> "



Part No.	Type	Hole Dia.	Mtg. Ctrs.
47699-001L	Offset Straddle	3/4"	5 <sup>11</sup> / <sub>16</sub> "



Part Shown: 44697-000L

Part No.	Type	Taper Threads	Length
44697-000L	Taper	1 <sup>1</sup> / <sub>4</sub> "	3"
46735-000L	Taper	1 <sup>1</sup> / <sub>4</sub> "	1 <sup>7</sup> / <sub>8</sub> "



Part Shown: 45477-000L

Part No.	Type	Length	Bushing O.D.	Hole Dia.
45477-000L	Thru Hole	3 <sup>1</sup> / <sub>4</sub> "	3"	1 <sup>1</sup> / <sub>8</sub> "
46736-000L	Thru Hole	3 <sup>1</sup> / <sub>4</sub> "	2 <sup>3</sup> / <sub>4</sub> "	1 <sup>1</sup> / <sub>8</sub> "
47692-000L	Thru Hole	3"	2"	7/8"

**Popular Parts**



**Solutions at Work**

[www.hendrickson-intl.com](http://www.hendrickson-intl.com)



**HENDRICKSON**

Truck Commercial Vehicle Systems  
800 South Frontage Road  
Woodridge, IL 60517-4904 USA

1.866.755.5968 (Toll-free U.S. and Canada)  
630.910.2800 (Outside U.S. and Canada)  
Fax 630.910.2899