



**TRAMEC**  
**SLOAN**

**PARTNERING WITH HEAVY DUTY FOR OVER 35 YEARS**



# Quick Reference Guide



This catalog is a combination of Tramec & Sloan part numbers that is laid out in two sections. The first section contains Tramec part numbers and the second section contains Sloan part numbers.

Below is a quick reference guide to help navigate through the catalog.

<p>Quick-Fix™</p> Page 3-5 Page 65	<p>Rubber Hose Assemblies</p> Page 6-8 Page 44-52	<p>Coiled Air Assemblies</p> Page 9 Page 53-55
<p>Push to Connect Composite Fittings</p> Page 10-12 Page 94	<p>Brass Fittings</p> Page 13-14 Page 91-121	<p>Reusable Hose Fittings</p> Page 14 Page 95-96
<p>Air Hose Accessories</p> Page 15-17 Page 66-70	<p>Gladhands and Accessories</p> Page 18-21 Page 74-81	<p>Drain Valves</p> Page 22 Page 87
<p>Air Brake Valves</p> Page 23-24 Page 126-137	<p>Plugs, Sockets and Cables</p> Page 25-41 Page 156-163	<p>Switches and Toggles</p> Page 42 Page 149-155

\* For A Complete Table Of Contents See Page II

# Table of Contents

Category	Page Number
Table of Contents	II
<b>TRAMEC PRODUCTS</b>	
Quick-Fix™	3-5*
Rubber Hose Assemblies	6-8*
Coiled Air Assemblies	9*
Push to Connect Composite Fittings	10-12*
Bulkhead Fittings/Terminal Bolts/Anchor Fittings	13*
Reusable Hose Fittings	14*
Air Hose Accessories	15-17*
Gladhands and Accessories	18-21*
Drain Valves	22*
Air Brake Valves	23-24*
Plugs, Sockets and Cables	25-41*
Switches and Toggles	42*
<b>AIR SYSTEM PRODUCTS</b>	
Rubber Hose Assemblies	44-52*
Coiled Air Assemblies	53-55*
3 in 1 & 4 in 1 Wrap	56-61
Bulk Hose	62-63
Air Compressor Discharge Hose Assemblies	64
Quick-Fix™	65*
Air Hose Accessories	66-70*
Hose Clamps	71-73
Gladhands and Accessories	74-81*
Air Tanks	82-86
Drain Valves	87*
Ground Plugs	88
Truck Valves	89
Selector Valves	90
Push to Connect Brass Fittings	92-93
Push to Connect Composite Fittings	94*
Rubber Hose (Reusable) Fittings	95-96*
Nylon Fittings	97-98
Compression Fittings	99-101
Transmission Shift Fittings	102
Pipe Fittings	103-105
Hose Barb Fittings	106-107

Category	Page Number
Push-On Fittings	108-109
Inverted Flare Fittings	110
45 Degree Flare Fittings	111-115
Copper Fittings	116-117
Bulkhead Fittings/Terminal Bolts /Anchor Fittings	118*
Hose and Tube Chart	119-121
Dash Control Valves	122-125
Air Brake Valves	126-137*
Air Accessory Valves	138-146
Air Cylinders	147-148
<b>ELECTRICAL</b>	
Switches and Toggles	149-155*
Plugs, Sockets and Cables	156-163*
RV Plugs and Sockets	164-165
Wire and Cable	166-173
Electrical Harnesses	174-177
Electrical Connectors	178-195
<b>ENGINE PRODUCTS</b>	
Fuel Caps	196-198
Oil Caps, Dipsticks, (includes interchange list)	199-201
Grease Fittings	202
Water Pumps	203-218
Engine Heaters	226-232
<b>WIPER BLADES</b>	
Michelin Wiper Blades	219-225
<b>WHEEL END PRODUCTS</b>	
Link Cat's Eye Tire Pressure Monitors	233
Hub Caps	234
Wheel Bearings & Nuts	235
<b>FLITZ</b>	
Polishes, Cleaners, and Kits	236-239
<b>MAXXGreen</b>	
Green Cleaners and Absorbent	240-241
<b>PART NUMBER INDEX</b>	
Full Part Number Index	242-256
Abbreviations	257

**\*Available in both Tramec and Sloan Versions**

**Suspension Products Now Available.**

Order Catalog SUSPCAT100 to View the Complete Listing or Contact Your Sales Representative For More Information.

## Air Brake Hose End Kits & Assemblies

- Meets the requirements of DOT 106 and SAE J1402.
- Swivel Ends reduce residual torque in hose for longer life — No need to disconnect both ends to service the brake system.
- Components in contact with the air are made of corrosion resistant brass and nylon to improve air system life.
- For pre-coated pipe threads, add the prefix “P” to the part number.
- When using with gladhands, add the suffix “B” to the part number to specify a brass barb (item E).



DESCRIPTION	PART NO.
Two End Fittings 3/8" NPTF	31402
Two End Fittings 1/2" NPTF	31403
One End Fitting 3/8" NPTF & One 1/4" NPTF Adapter	31407

**Kits Are Not Available for 1/2" I.D. Hose.** See page 5 for shop assembled 1/2" hose options.

## Installation Procedure

**Step 1.** Disassemble Kit.

**Step 2.** Position hose end on SHELL (A) flush with groove (see arrows).

**Step 3.** Insert FITTING (B) into groove and position SHELL (C) opposite SHELL (A).

**Step 4.** With assembly in hand, squeeze forward ends of shells and push and twist RING (D) over shells to its final position as shown by arrows.

**Step 5.** Insert BARB (E) into fitting. (Threaded end of barb should be greased.) Push and turn to start threads. Using a 5/16" hexagon key continue to push and turn until the barb is flush inside the fitting. **NOTE:** Check final assembly visually to insure that hose has not shifted position during assembly.

<b>Tramec</b>
<b>Brake Hose End Kits</b>
<b>Brake Hose Fittings</b>
<b>Brake Hoses</b>
<b>Coiled Air, Push to Connect Fittings</b>
<b>Push to Connect Fittings</b>
<b>Bulkhead Fittings</b>
<b>Reusable Hose Fittings</b>
<b>Pogo Stick &amp; Accessories</b>
<b>Clamps &amp; Suspenders</b>
<b>Springs, Spacers, Clips</b>
<b>Gladhand Seals &amp; Accessories, Locks</b>
<b>Gladhands</b>
<b>Swivel Gladhands &amp; Accessories</b>
<b>Gladhands: Swivel, Bracket, Shutoff</b>
<b>Drain Valves, Safety Valves</b>
<b>Quick Release Valves</b>
<b>Spring Brake Valves</b>
<b>SONOGRIP® Cables</b>
<b>7-Way Cables / Zinc Plugs</b>
<b>Bulk Cable, 30-Pin 7-Way Receptacles</b>
<b>7-Way Receptacles</b>
<b>7-Way Receptacles &amp; Adapter Boxes</b>
<b>Smart Box® 7-Way Receptacles</b>
<b>Small Nylon 7-Way Receptacles</b>
<b>Over Molded 7-Way Receptacles</b>
<b>Zinc 7-Way Receptacles &amp; Boxes</b>
<b>7-Way Lid Kits &amp; Parts, Nylon 4-Way</b>
<b>Breakers, Zinc 7-Way Plugs and Sockets</b>
<b>Single Pole, 4&amp;6-Way Plugs &amp; Sockets</b>
<b>Switches</b>

## Hose End Kits For 3/8" I.D. Hose Manufactured To DOT 106 Specifications. (Cont'd)

- Add Prefix "P" for pre-coated pipe threads.
- When using with gladhands, add the suffix "B" to the part number to specify a brass barb.



31409B



31410  
Universal Repair Kit

DESCRIPTION	PART NO.
One 3/8" NPTF end fitting with 3 1/2" spring guard length	31408
One 1/2" NPTF end fitting with 3 1/2" spring guard length	31409B
One 3/8" end fitting + 1/4" NPTF adapter + 1/2" NPTF reducer + 3/8" x 3/8" NPTF coupler	31410
Spring guard, length 3 1/2"	34019
Spring guard, length 10 1/2"	34033
Spring guard, length 19", not belled	34037



34019

## Brass Fittings:

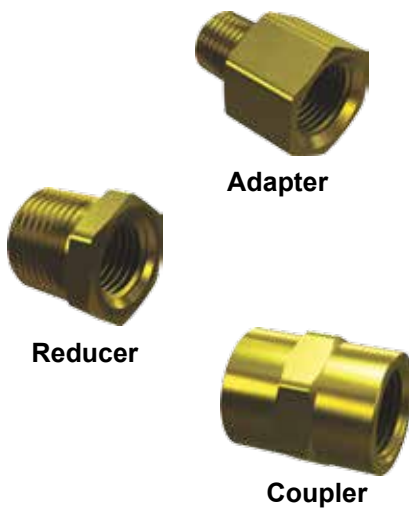

Adapter

Reducer

Coupler

DESCRIPTION	PART NO.
Adapter 3/8"F x 1/4"M	33009
Reducer 1/4"M x 1/8"F	33010
Reducer 3/8"M x 1/4"F	33011
Reducer 1/2"M x 1/4"F	33012
Reducer 1/2"M x 3/8"F	33013
Reducer 3/4"M x 3/8"F	33014
Reducer 3/4"M x 1/2"F	33015
Coupler 3/8"F x 3/8"F	33016
Coupler 1/2"F x 1/2"F	33018

## Hose Assembly Techniques: Low Volume Production Requirements 3/8" I.D. Hose

For relatively low volume production needs the steps illustrated on page 4 may be followed except for the use of a variable speed screw driver with a 5/16" hex bit for step no. 5.

**CAUTION:** Use very low speed only, and turn only until barb is flush with fitting.



## For Shop Production Requirements

TRAMEC has developed the HA300 assembly fixture for users of our Hose End Kits and Bulk Pack Fittings. The fixture can be used to assemble both 3/8" and 1/2" I.D. airbrake hose.



HA 300

## Bulk Packaged Hose Fittings

HOSE I.D.	NPTF	PART NO.
3/8"	3/8"	31302
3/8"	1/2"	31303
1/2"	3/8"	31305
1/2"	1/2"	31306

- To order pre-coated pipe threads add prefix "P" to part number.
- When using with gladhands, add the suffix "B" to the part number to specify a brass barb.

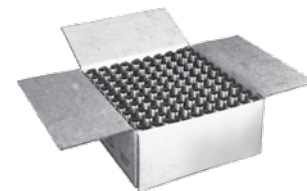

Bulk Fittings

## Bulk Hose, Dot 106, SAE J1402

Hose I.D.	DESCRIPTION	PART NO.
3/8"	Box, 50'	31102
3/8"	Reel, 250'	31002
3/8"	Reel, 500'	3160001
1/2"	Box, 50'	31105
1/2"	Reel, 250'	31005
1/2"	Reel, 500'	3180001

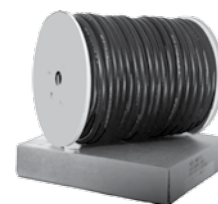

Bulk Hose

### Tramec

Brake Hose End Kits

Brake Hose Fittings

Brake Hoses

Coiled Air, Push to Connect Fittings

Push to Connect Fittings

Bulkhead Fittings

Reusable Hose Fittings

Pogo Stick & Accessories

Clamps & Suspenders

Springs, Spacers, Clips

Gladhand Seals & Accessories, Locks

Gladhands

Swivel Gladhands & Accessories

Gladhands: Swivel, Bracket, Shutoff

Drain Valves, Safety Valves

Quick Release Valves

Spring Brake Valves

SONOGRIP® Cables

7-Way Cables / Zinc Plugs

Bulk Cable, 30-Pin 7-Way Receptacles

7-Way Receptacles

7-Way Receptacles & Adapter Boxes

Smart Box® 7-Way Receptacles

Small Nylon 7-Way Receptacles

Over Molded 7-Way Receptacles

Zinc 7-Way Receptacles & Boxes

7-Way Lid Kits & Parts, Nylon 4-Way

Breakers, Zinc 7-Way Plugs and Sockets

Single Pole, 4&6-Way Plugs & Sockets

Switches



31002-XXX

### Heavy Duty Hose Assembly

- Both ends swivel
- Meets DOT 106 and SAE J1402.
- Add Prefix "P" for pre-coated pipe threads.
- When using 3/8" hose with gladhands, insert "B" before "XXX" to specify a brass barb (for example, 31009B072).
- Arctic Hose is available — Contact Factory.

HOSE I.D.	END FITTING	PART NO.
3/8"	3/8" x 3/8" NPTF	31002-XXX
3/8"	1/2" x 1/2" NPTF	31003-XXX
1/2"	3/8" x 3/8" NPTF	31005-XXX
1/2"	1/2" x 1/2" NPTF	31006-XXX
3/8"	3/8" x 1/2" NPTF	31009-XXX
1/2"	3/8" x 1/2" NPTF	31012-XXX

XXX = Overall length in inches

31502-XXX



### Hose Assembly With Spring Guard

- Both ends swivel
- Meets DOT 106 and SAE J1402.
- Add Prefix "P" for pre-coated pipe threads.
- When using 3/8" hose with gladhands, insert "B" before "XXX" to specify a brass barb (for example, 31009B072).
- Arctic Hose is available — Contact Factory.

HOSE I.D.	END FITTING	PART NO.
3/8"	3/8" x 3/8" NPTF	31502-XXX
3/8"	1/2" x 1/2" NPTF	31503-XXX
3/8"	3/8" x 1/2" NPTF	31509-XXX
1/2"	3/8" x 3/8" NPTF	31505-XXX
1/2"	1/2" x 1/2" NPTF	31506-XXX
1/2"	3/8" x 1/2" NPTF	31512-XXX

XXX = Overall length in inches

## Heavy Duty Hose Assembly

- One end swivel nut with adapter.
- One end fixed.
- Meets DOT 106 and SAE J1402.
- Add Prefix "P" for pre-coated pipe threads.

HOSE I.D.	END FITTING	PART NO.
3/8"	1/4" x 1/4" NPTF	32001-XXX
3/8"	3/8" x 3/8" NPTF	32002-XXX
3/8"	1/2" x 1/2" NPTF	32003-XXX
1/2"	3/8" x 3/8" NPTF	32005-XXX
1/2"	1/2" x 1/2" NPTF	32006-XXX
3/8"	1/4" x 3/8" NPTF	32007-XXX
3/8"	1/4" x 1/2" NPTF	32008-XXX
3/8"	3/8" x 1/2" NPTF	32009-XXX
1/2"	1/4" x 3/8" NPTF	32010-XXX
1/2"	1/4" x 1/2" NPTF	32011-XXX
1/2"	3/8" x 1/2" NPTF	32012-XXX

XXX = Overall length in inches

## Hose Assembly With Spring Guard

- One end swivel nut with adapter.
- One end fixed.
- Meets DOT 106 and SAE J1402.
- Add Prefix "P" for pre-coated pipe threads.

HOSE I.D.	END FITTING	PART NO.
3/8"	3/8" x 3/8" NPTF	32502-XXX
3/8"	1/2" x 1/2" NPTF	32503-XXX
3/8"	3/8" x 1/2" NPTF	32509-XXX
1/2"	3/8" x 3/8" NPTF	32505-XXX
1/2"	1/2" x 1/2" NPTF	32506-XXX
1/2"	3/8" x 1/2" NPTF	32512-XXX
3/8"	1/2" x 1/2" NPTF	32516-XXX *

XXX = Overall length in inches

- \* 32516-XXX: Special 3/8" I.D. Hose Assembly for Gladhands. Both Ends have 1/2"-14 NPTF Non-Swivel Fittings and Spring Guards

## Adapter

PIPE THRD.	STRT. THRD.	PART NO.
1/4" - 18	3/4" - 20	34093
3/8" - 18	3/4" - 20	34094
1/2" - 14	3/4" - 20	34098



32002-XXX



32516-XXX



Adapter

### Tramec

#### Brake Hose End Kits

#### Brake Hose Fittings

#### Brake Hoses

#### Coiled Air, Push to Connect Fittings

#### Push to Connect Fittings

#### Bulkhead Fittings

#### Reusable Hose Fittings

#### Pogo Stick & Accessories

#### Clamps & Suspenders

#### Springs, Spacers, Clips

#### Gladhand Seals & Accessories, Locks

#### Gladhands

#### Swivel Gladhands & Accessories

#### Gladhands: Swivel, Bracket, Shutoff

#### Drain Valves, Safety Valves

#### Quick Release Valves

#### Spring Brake Valves

#### SONOGRIP® Cables

#### 7-Way Cables / Zinc Plugs

#### Bulk Cable, 30-Pin 7-Way Receptacles

#### 7-Way Receptacles

#### 7-Way Receptacles & Adapter Boxes

#### Smart Box® 7-Way Receptacles

#### Small Nylon 7-Way Receptacles

#### Over Molded 7-Way Receptacles

#### Zinc 7-Way Receptacles & Boxes

#### 7-Way Lid Kits & Parts, Nylon 4-Way

#### Breakers, Zinc 7-Way Plugs and Sockets

#### Single Pole, 4&6-Way Plugs & Sockets

#### Switches



32201-XXX



### Slider Hose Assemblies

- 3/8" I.D. Airbrake Hose to meet DOT 106 & SAE J1402
- 7/8" - 20 Mounting Thread on Anchor Fitting
- XXX = Overall Length in inches.

### Serviceable Slider Hose Assemblies

- Hose Assemblies mated to Anchor Fitting by Pipe Thread
- Replacement of the Hose Without Disturbing Tubing Connection

TUBE SIZE O.D.	SPRING GUARD	PART NO.
3/8"	YES	32201-XXX
1/2"	YES	32202-XXX
3/8"	NO	32205-XXX
1/2"	NO	32206-XXX

32301-XXX

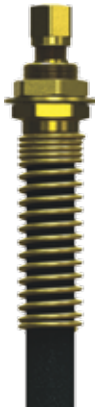

### Standard Slider Hose Assemblies

- Anchor Fitting for Tubing Crimped Directly Onto Hose

TUBE SIZE O.D.	SPRING GUARD	PART NO.
3/8"	YES	32301-XXX
1/2"	YES	32302-XXX
3/8"	1 @ 3" / 1 @ 12"	32305-XXX
3/8"	NO	32319-XXX
1/2"	NO	32320-XXX

- Consult factory for special applications not shown above

32801-XXX



### Special 1/4" I.D. Control Line Slider Hose

- 1/4" I.D. Airbrake Hose to meet DOT 106 for Improved Timing
- Anchor Fitting for Tubing Crimped Directly Onto Hose

TUBE SIZE O.D.	SPRING GUARD	PART NO.
3/8"	YES	32801-XXX
3/8"	NO	32802-XXX

## Coiled Nylon Air Brake Tube

- Meets DOT 106 & 393.45, and SAE J844 & SAE J1131
- Pairs Packaged in sets of One Red & One Blue
- Both Ends 1/2" Pipe Thread

WORKING LENGTH	Leads		PAIR PART NO.	SINGLE COLOR	SINGLE PART NO.
12'	8"	8"	55100	Blue Red	55100B 55100R
15'	12"	12"	55101	Blue Red	55101B 55101R
15'	40"	12"	55103	Blue Red	55103B 55103R



55101B

## Gladhand Grips

- Gladhand Grip Extensions for easy coupling
- Tough molded grips with plated steel fittings, or
- Anodized aluminum with knurled finish

DESCRIPTION	PART NO.
Pair Molded Grips (One Blue & One Red)	36430
Pair Aluminum Grips (One Blue & One Red)	36440

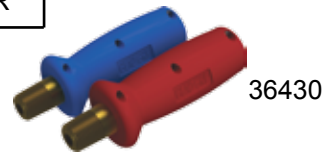

36430



36440

- 3/8 Air Brake Hoses with 1/2" NPT Both Ends
- Valve ends have Swivel Fittings for Easy Installation

DESCRIPTION	PART NO.
Pair Hoses with Blue & Red Molded Grips	31540-XXX
Pair Hoses with Blue & Red Aluminum Grips	31550-XXX

XXX = Overall Length in inches.

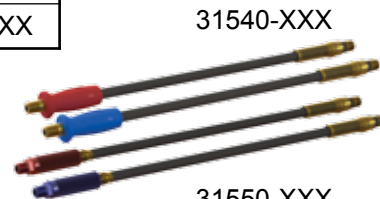

31540-XXX

31550-XXX

## Push to Connect Air Brake Tube Fittings

- One Touch connection reduces installation time & Cost
- Rugged UV and Vibration Resistant Composite Body
- Meets DOT 106, SAE J1131, and SAE J2494
- Male Pipe Threads are Pre-Sealed

### Male Connector: KV2H

Tube O.D.	Thread (NPTF)	PART NO.
5/32"	1/16"	KV2H03-33S
	1/8"	KV2H03-34S
	1/4"	KV2H03-35S
1/4"	1/8"	KV2H07-34S
	1/4"	KV2H07-35S
	3/8"	KV2H07-36S
3/8"	1/8"	KV2H11-34S
	1/4"	KV2H11-35S

Tube O.D.	Thread (NPTF)	PART NO.
3/8"	3/8"	KV2H11-36S
	1/2"	KV2H11-37S
1/2"	1/4"	KV2H13-35S
	3/8"	KV2H13-36S
	1/2"	KV2H13-37S
5/8"	3/8"	KV2H15-36S
	1/2"	KV2H15-37S
3/4"	3/8"	KV2H19-36S
	1/2"	KV2H19-37S



### Tramec

#### Brake Hose End Kits

#### Brake Hose Fittings

#### Brake Hoses

#### Coiled Air, Push to Connect Fittings

#### Push to Connect Fittings

#### Bulkhead Fittings

#### Reusable Hose Fittings

#### Pogo Stick & Accessories

#### Clamps & Suspenders

#### Springs, Spacers, Clips

#### Gladhand Seals & Accessories, Locks

#### Gladhands

#### Swivel Gladhands & Accessories

#### Gladhands: Swivel, Bracket, Shutoff

#### Drain Valves, Safety Valves

#### Quick Release Valves

#### Spring Brake Valves

#### SONOGRIP® Cables

#### 7-Way Cables / Zinc Plugs

#### Bulk Cable, 30-Pin 7-Way Receptacles

#### 7-Way Receptacles

#### 7-Way Receptacles & Adapter Boxes

#### Smart Box® 7-Way Receptacles

#### Small Nylon 7-Way Receptacles

#### Over Molded 7-Way Receptacles

#### Zinc 7-Way Receptacles & Boxes

#### 7-Way Lid Kits & Parts, Nylon 4-Way

#### Breakers, Zinc 7-Way Plugs and Sockets

#### Single Pole, 4&6-Way Plugs & Sockets

#### Switches

## Push to Connect Air Brake Tube Fittings

Continued

### Male Elbow: KV2L

- May be rotated to position after installing thread



Tube O.D.	Thread (NPTF)	PART NO.
5/32"	1/8"	KV2L03-34S
1/4"	1/8"	KV2L07-34S
	1/4"	KV2L07-35S
	3/8"	KV2L07-36S
3/8"	1/8"	KV2L11-34S
	1/4"	KV2L11-35S
	3/8"	KV2L11-36S
	1/2"	KV2L11-37S

Tube O.D.	Thread (NPTF)	PART NO.
1/2"	1/4"	KV2L13-35S
	3/8"	KV2L13-36S
	1/2"	KV2L13-37S
5/8"	3/8"	KV2L15-36S
	1/2"	KV2L15-37S
3/4"	1/2"	KV2L19-37S

### 45° Male Elbow: KV2K

- May be rotated to position after installing thread



Tube O.D.	Thread (NPTF)	PART NO.
5/32"	1/8"	KV2K03-34S
1/4"	1/8"	KV2K07-34S
	1/4"	KV2K07-35S
	3/8"	KV2K07-36S
3/8"	1/8"	KV2K11-34S
	1/4"	KV2K11-35S
	3/8"	KV2K11-36S
	1/2"	KV2K11-37S

Tube O.D.	Thread (NPTF)	PART NO.
1/2"	1/4"	KV2K13-35S
	3/8"	KV2K13-36S
	1/2"	KV2K13-37S
5/8"	3/8"	KV2K15-36S
	1/2"	KV2K15-37S
3/4"	3/8"	KV2K19-36S
	1/2"	KV2K19-37S

### Male Run Tee: KV2Y

- May be rotated to position after installing thread



Tube O.D.	Thread (NPTF)	PART NO.
5/32"	1/16"	KV2Y03-33S
	1/8"	KV2Y03-34S
	1/4"	KV2Y03-35S
1/4"	1/8"	KV2Y07-34S
	1/4"	KV2Y07-35S
	3/8"	KV2Y07-36S

Tube O.D.	Thread (NPTF)	PART NO.
3/8"	1/4"	KV2Y11-35S
	3/8"	KV2Y11-36S
	1/2"	KV2Y11-37S
1/2"	1/4"	KV2Y13-35S
	3/8"	KV2Y13-36S
	1/2"	KV2Y13-37S

### Male Branch Tee: KV2T

- May be rotated to position after installing thread

Tube O.D.	Thread (NPTF)	PART NO.
5/32"	1/16"	KV2T03-33S
	1/8"	KV2T03-34S
	1/4"	KV2T03-35S
1/4"	1/8"	KV2T07-34S
	1/4"	KV2T07-35S
	3/8"	KV2T07-36S
3/8"	1/8"	KV2T11-34S
	1/4"	KV2T11-35S

Tube O.D.	Thread (NPTF)	PART NO.
3/8"	3/8"	KV2T11-36S
	1/2"	KV2T11-37S
1/2"	1/4"	KV2T13-35S
	3/8"	KV2T13-36S
	1/2"	KV2T13-37S
5/8"	3/8"	KV2T15-36S
	1/2"	KV2T15-37S



### Female Branch Tee: KV2TF

- May be rotated to position after installing thread

Tube O.D.	Thread (NPTF)	PART NO.
1/4"	1/8"	KV2TF07-34
	1/4"	KV2TF07-35
3/8"	1/4"	KV2TF11-35

Tube O.D.	Thread (NPTF)	PART NO.
1/2"	3/8"	KV2TF13-36
5/8"	1/4"	KV2TF15-35



### Female Connector: KV2F

Tube O.D.	Thread (NPTF)	PART NO.
5/32"	1/8"	KV2F03-34
	1/4"	KV2F03-35
1/4"	1/8"	KV2F07-34
	1/4"	KV2F07-35
	3/8"	KV2F07-36

Tube O.D.	Thread (NPTF)	PART NO.
3/8"	1/8"	KV2F11-34
	1/4"	KV2F11-35
	3/8"	KV2F11-36
	1/2"	KV2F11-37
1/2"	1/8"	KV2F13-34
	1/4"	KV2F13-35
	3/8"	KV2F13-36
	1/2"	KV2F13-37



### Female Elbow: KV2LF

- May be rotated to position after installing thread

Tube O.D.	Thread (NPTF)	PART NO.
5/32"	1/8"	KV2LF03-34
	1/4"	KV2LF03-35
1/4"	1/8"	KV2LF07-34
	1/4"	KV2LF07-35
	3/8"	KV2LF07-36

Tube O.D.	Thread (NPTF)	PART NO.
3/8"	1/8"	KV2LF11-34
	1/4"	KV2LF11-35
	3/8"	KV2LF11-36
	1/2"	KV2LF11-37
1/2"	1/4"	KV2LF13-35
	3/8"	KV2LF13-36
	1/2"	KV2LF13-37



#### Tramec

- Brake Hose End Kits
- Brake Hose Fittings
- Brake Hoses
- Coiled Air, Push to Connect Fittings
- Push to Connect Fittings
- Bulkhead Fittings
- Reusable Hose Fittings
- Pogo Stick & Accessories
- Clamps & Suspenders
- Springs, Spacers, Clips
- Gladhand Seals & Accessories, Locks
- Gladhands
- Swivel Gladhands & Accessories
- Gladhands: Swivel, Bracket, Shutoff
- Drain Valves, Safety Valves
- Quick Release Valves
- Spring Brake Valves
- SONOGRIP® Cables
- 7-Way Cables / Zinc Plugs
- Bulk Cable, 30-Pin 7-Way Receptacles
- 7-Way Receptacles
- 7-Way Receptacles & Adapter Boxes
- Smart Box® 7-Way Receptacles
- Small Nylon 7-Way Receptacles
- Over Molded 7-Way Receptacles
- Zinc 7-Way Receptacles & Boxes
- 7-Way Lid Kits & Parts, Nylon 4-Way
- Breakers, Zinc 7-Way Plugs and Sockets
- Single Pole, 4&6-Way Plugs & Sockets
- Switches

## Push to Connect Air Brake Tube Fittings

Continued

### Straight Union: KV2H-00



Tube O.D.	PART NO.
5/32"	KV2H03-00
1/4"	KV2H07-00
3/8"	KV2H11-00

Tube O.D.	PART NO.
1/2"	KV2H13-00
5/8"	KV2H15-00
5/32" - 1/4"	KV2H03-07
1/4" - 3/8"	KV2H07-11

### Union Elbow: KV2L-00



Tube O.D.	PART NO.
5/32"	KV2L03-00
1/4"	KV2L07-00

Tube O.D.	PART NO.
3/8"	KV2L11-00
1/2"	KV2L13-00

### Union Tee: KV2T-00



Tube O.D.	PART NO.
5/32"	KV2T03-00
1/4"	KV2T07-00
3/8"	KV2T11-00

Tube O.D.	PART NO.
1/2"	KV2T13-00
5/8"	KV2T15-00

### Bulkhead Union: KV2E-00

- Maximum mounting plate thickness 11mm (7/16")



Tube O.D.	Thread	PART NO.
5/32"	1/2-20	KV2E03-00
1/4"	9/16-18	KV2E07-00
3/8"	7/8-14	KV2E11-00

Tube O.D.	Thread	PART NO.
1/2"	1-12	KV2E13-00
5/8"	1 1/8-12	KV2E15-00

### Bulkhead Connector: KV2E

- Maximum mounting plate thickness 7mm (1/4")

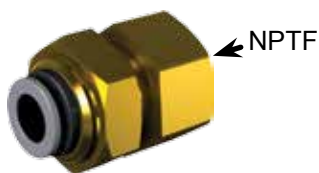

Tube O.D.	Thread (NPTF)	PART NO.
5/32"	1/4"	KV2E03-35
1/4"	1/8"	KV2E07-34
	1/4"	KV2E07-35

Tube O.D.	Thread (NPTF)	PART NO.
3/8"	1/4"	KV2E11-35
	3/8"	KV2E11-36
1/2"	3/8"	KV2E13-36
	1/2"	KV2E13-37

### Plugs: KV2P



Tube O.D.	PART NO.
5/32"	KV2P-03
1/4"	KV2P-07

Tube O.D.	PART NO.
3/8"	KV2P-11
1/2"	KV2P-13

### Clamping Studs

O.A.L.	C	M (NPT)	B (NPT)	PART NO.
2-1/8"	1"	1/2"	3/8"	50001
1- 5/8"	3/4"	1/2"	1/4"	50002
2-5/32"	3/4"	1/2"	1/4"	50003
1-5/8"	7/8"	1/2"	1/2" O.D. Tube	50018
1-5/8"	7/8"	1/2"	3/8"	50019
1-3/4"	3/4"	1/2"	1/4" x 2	50027



### Anchor Fitting

O.A.L.	C	A (NPT)	B (NPT)	PART NO.
1-1/2"	5/8"	1/8"	1/8"	50004
1-1/2"	3/4"	1/4"	1/4"	50005
1-5/16"	1"	3/8"	3/8"	50006
1-1/2"	1 1/8"	1/2"	1/2"	50007

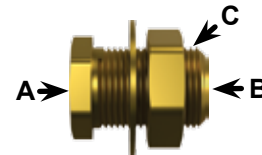

### Anchor Fitting for Tubing

O.A.L.	A (NPT)	B	C	PART NO.
1-3/8"	3/8"	1/2" O.D. Tube	7/8"	50008
1-3/8"	3/8"	3/8" O.D. Tube	7/8"	50009

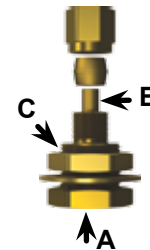

### Clamping Studs

O.A.L.	C	M (NPT)	B (NPT)	PART NO.
2-15/16"	1"-14	1/2"	1/4"	50010
3-15/16"	1"-14	1/2"	1/4"	50011

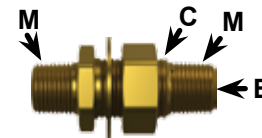

### Clamping Studs

O.A.L.	A (NPT)	B (NPT)	C	PART NO.
2.10"	1/2"	1/2"	1"-14	50012
1.85"	3/8"	1/2"	1"-14	50013

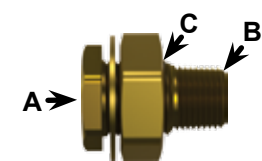

### 90° Anchor Fitting

L	A	B (NPTF)	C	PART NO.
.7"	3/8" NPTF	3/8"	7/8"-20x.8	50016
.7"	3/8" NPTF	3/8"	7/8"-20x1.2	50016A
1.8"	3/8" NPTF	3/8"	7/8"-20x.8	50017

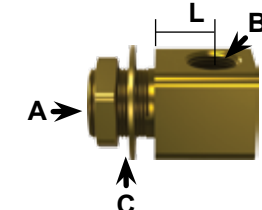

### Tramec

- Brake Hose End Kits
- Brake Hose Fittings
- Brake Hoses
- Coiled Air, Push to Connect Fittings
- Push to Connect Fittings
- Bulkhead Fittings
- Reusable Hose Fittings
- Pogo Stick & Accessories
- Clamps & Suspenders
- Springs, Spacers, Clips
- Gladhand Seals & Accessories, Locks
- Gladhands
- Swivel Gladhands & Accessories
- Gladhands: Swivel, Bracket, Shutoff
- Drain Valves, Safety Valves
- Quick Release Valves
- Spring Brake Valves
- SONOGRIP® Cables
- 7-Way Cables / Zinc Plugs
- Bulk Cable, 30-Pin 7-Way Receptacles
- 7-Way Receptacles
- 7-Way Receptacles & Adapter Boxes
- Smart Box® 7-Way Receptacles
- Small Nylon 7-Way Receptacles
- Over Molded 7-Way Receptacles
- Zinc 7-Way Receptacles & Boxes
- 7-Way Lid Kits & Parts, Nylon 4-Way
- Breakers, Zinc 7-Way Plugs and Sockets
- Single Pole, 4&6-Way Plugs & Sockets
- Switches

## Air Brake Hose Ends

• Add Prefix "P" for pre-coated pipe threads.

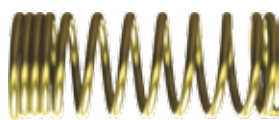
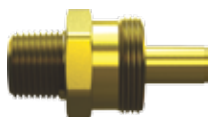

HOSE I.D.	PIPE THREAD	PART NO.
<b>Connector With Spring Guard</b>		
3/8"	1/4" - 18	34001
3/8"	3/8" - 18	34003
3/8"	1/2" - 14	34002
1/2"	3/8" - 18	34076
1/2"	1/2" - 14	34077
<b>Connector — No Spring Guard</b>		
3/8"	1/4" - 18	34001A
3/8"	3/8" - 18	34003A
3/8"	1/2" - 14	34002A
1/2"	3/8" - 18	34076A
1/2"	1/2" - 14	34077A
<b>Swivel Connector With Adapter</b>		
3/8"	1/4" - 18	34078
3/8"	3/8" - 18	34079
3/8"	1/2" - 14	34097
1/2"	3/8" - 18	34080
1/2"	1/2" - 14	34081
<b>Hose Mender</b>		
3/8"	—	34082
1/2"	—	34083
<b>Insert</b>		
3/8"	1/4" - 18	34084
3/8"	3/8" - 18	34085
3/8"	1/2" - 14	34086
1/2"	3/8" - 18	34087
1/2"	1/2" - 14	34088
<b>Ferrule</b>		
3/8"	—	34074
1/2"	—	34075
<b>Nut For Spring Guard</b>		
3/8"	—	34089
1/2"	—	34090
<b>Nut</b>		
3/8"	—	34089A
1/2"	—	34090A
<b>Spring Guard</b>		
3/8"	—	34091
1/2"	—	34092

## Swivel Stick and Parts

- Steel Support Arm - Choice of Chrome, or Zinc & Yellow Dichromate
- 41" Post pivots at base.
- Standard Bracket & Docker mounting holes
- 7/16"-20 x 2.6" mounting stud,

DESCRIPTION	PART NO.
Chromed Swivel Stick Only	34200
Zinc & Dichromate Stick	34260
Zinc & Dichromate Stick with 34275 Ring	34259
Support clamp for 3/8" I.D. Hose and Cable (includes eye-bolt)	34213
Support clamp for 1/2" O.D. Tube and Cable (includes eye-bolt)	34220
Steel Ring (includes eye-bolt) Yellow Dichromate	34275
Straps (includes eye-bolt) Gladhand brackets with installation hardware for swivel stick mounting	34241 Please order in multiples of Two.
Yellow Dichromate	34251
Yellow Dichromate with Vent Hole	34287
Gladhand brackets without installation hardware for swivel stick mounting	
Yellow Dichromate	3420051
Yellow Dichromate with Vent Hole	3420087

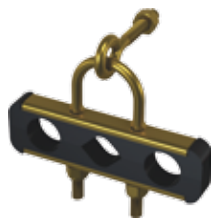

34213 For 3/8 ID Hose  
34220 For 1/2 OD Tube



34275



34241



3420051



34260

## Docker for Gladhands and Seven-way Connector

The plug socket and gladhand brackets are angled to the driver's side of the vehicle for safe and efficient docking.

DESCRIPTION	PART NO.
No mounting hardware	34211
Supplied with Hardware for Swivel Stick Mounting	34212
Swivel Stick Mounting Kit (hardware only)	34250



34211

### Tramec

#### Brake Hose End Kits

#### Brake Hose Fittings

#### Brake Hoses

#### Coiled Air, Push to Connect Fittings

#### Push to Connect Fittings

#### Bulkhead Fittings

#### Reusable Hose Fittings

#### Pogo Stick & Accessories

#### Clamps & Suspenders

#### Springs, Spacers, Clips

#### Gladhand Seals & Accessories, Locks

#### Gladhands

#### Swivel Gladhands & Accessories

#### Gladhands: Swivel, Bracket, Shutoff

#### Drain Valves, Safety Valves

#### Quick Release Valves

#### Spring Brake Valves

#### SONOGRIP® Cables

#### 7-Way Cables / Zinc Plugs

#### Bulk Cable, 30-Pin 7-Way Receptacles

#### 7-Way Receptacles

#### 7-Way Receptacles & Adapter Boxes

#### Smart Box® 7-Way Receptacles

#### Small Nylon 7-Way Receptacles

#### Over Molded 7-Way Receptacles

#### Zinc 7-Way Receptacles & Boxes

#### 7-Way Lid Kits & Parts, Nylon 4-Way

#### Breakers, Zinc 7-Way Plugs and Sockets

#### Single Pole, 4&6-Way Plugs & Sockets

#### Switches





### Two Hole Clamps

DESCRIPTION	PART NO.
Eye-bolt for 3/8" I.D. hose	34268
Eye-bolt for 1/2" I.D. hose	34269
Eye-bolt for 3/8" & 1/4" I.D. hose	34160
Hex-bolt for 3/8" I.D. hose	34270
Hex-bolt for 1/2" I.D. hose	34271
Hex-bolt for 3/8" & 1/4" I.D. hose	34161

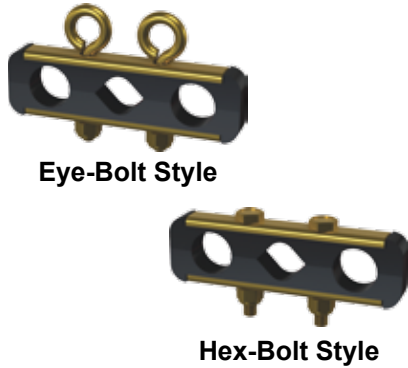

### Heavy Duty Clamps

DESCRIPTION	PART NO.
Double eye-bolt for 3/8" I.D. hose and cable	34229
Double eye-bolt for 1/2" O.D. tubing and cable	34228
Dbl eye-bolt for 3/8" & 1/4" I.D. hose and cable	34170
Bolt clamp for 3/8" I.D. hose & 3/8" cable	34246
Bolt clamp for 1/2" O.D. tubing and cable	34247
Bolt clamp for 3/8" & 1/4" I.D. hose & 3/8" cable	34171



### Heavy Duty Clamps

DESCRIPTION	PART NO.
For 4 each 3/8" I.D. Hose	3420097
For 2 ea 3/8" I.D. Hose & 4 ea 1/4" Hose or Cable	3410009



### Hose Kaddy Parts

- 2" I.D. x 1/4" Steel Ring Zinc Plated.
- Pre-Assembled Suspenders.

DESCRIPTION	PART NO.
13" Suspender for 3/8" I.D. Hose & 7-Way Cable	34056
13" Suspender for 1/2" O.D. Tubing & 7-Way Cable	34058
Double 13" Suspender for 3/8" I.D. Hose & 7-Way Cable	34060
Double 25" Suspender for 3/8" I.D. Hose & 7-Way Cable	34061
Double 25" Suspender for 1/2" O.D. Tube & 7-Way Cable	34063
2" ID. x 1/4" Steel Ring Only	34051

### Support Springs

- High tensile spring steel.
- Zinc plated, yellow dichromated.

LENGTH	DESCRIPTION O.D.	WIRE	PART NO.
13"	1"	.072	34015
16.4"	1"	.080	34114
25"	1 1/16"	.080	34017
14.2"	1 1/8"	.080	34117



Support Spring

### Beam Flange Fastener

- For 1/8" to 1/4" Flange Thickness, Zinc Plate & Dichromate Finish

DESCRIPTION	PART NO.
Beam Flange Fastener	34118



34118

### Hose Spacer/Hanger Clamps

- High quality material for added low temperature and impact resistance.
- Ultra-Violet Resistant.
- Versatile design for diverse applications.

HOSE I.D.		PART NO.
A	B	
3/8"	3/8"	34020
1/2"	1/2"	34021
1/2"	3/8"	34022
3/8"	1/4"	34150



Hose Spacer

### Full Clips, Vinyl Coated

DESCRIPTION	PART NO.
1/4" I.D. x 9/32" mounting hole	34009
5/16" I.D. x 9/32" mounting hole	34010
3/8" I.D. x 9/32" mounting hole	34011
1/2" I.D. x 9/32" mounting hole	34012
5/8" I.D. x 9/32" mounting hole	34013
3/4" I.D. x 9/32" mounting hole	34014



Full Clip

#### Tramec

Brake Hose End Kits

Brake Hose Fittings

Brake Hoses

Coiled Air, Push to Connect Fittings

Push to Connect Fittings

Bulkhead Fittings

Reusable Hose Fittings

Pogo Stick & Accessories

Clamps & Suspenders

Springs, Spacers, Clips

Gladhand Seals & Accessories, Locks

Gladhands

Swivel Gladhands & Accessories

Gladhands: Swivel, Bracket, Shutoff

Drain Valves, Safety Valves

Quick Release Valves

Spring Brake Valves

SONOGRIP® Cables

7-Way Cables / Zinc Plugs

Bulk Cable, 30-Pin 7-Way Receptacles

7-Way Receptacles

7-Way Receptacles & Adapter Boxes

Smart Box® 7-Way Receptacles

Small Nylon 7-Way Receptacles

Over Molded 7-Way Receptacles

Zinc 7-Way Receptacles & Boxes

7-Way Lid Kits & Parts, Nylon 4-Way

Breakers, Zinc 7-Way Plugs and Sockets

Single Pole, 4&6-Way Plugs & Sockets

Switches



36001



36003



36002



36015

### Gladhand Accessories

DESCRIPTION	PART NO.
Double Lip Seal	36001
Polyurethane Double Lip Seal - Gray	36010
Polyurethane Double Lip Seal - Blue	36011
Polyurethane Double Lip Seal - Red	36012
Single Lip Seal	36003
Stainless Steel Filter	36002
Polyurethane Narrow Lip Seal - Black	36015
Polyurethane Narrow Lip Seal - Blue	36016
Polyurethane Narrow Lip Seal - Red	36017

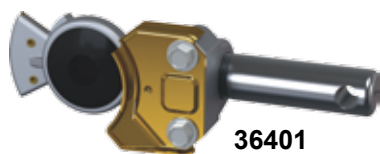

36401



36420

### Dummy Gladhands

- Cable is Nylon Coated Galvanized Steel

DESCRIPTION	PART NO.
Universal Gladhand On Handle (Dummy)	36401
36401 Dummy w/18" x 5/64" O.D. Cable	36403
Handle Only w/18" x 5/64" O.D. Cable	36405
36401 Dummy w/18" x 1/8" O.D. Cable	36413
Solid Cast Aluminum Gladhand On Handle	36420
36420 Dummy w/ 18" x 1/8" O.D. Cable	36416



36406

ORD. NO.	STAMPING (w/ Chain)	PART NO.
7411021	With Vent Hole - 9.34"	36406
7014965	No Vent Hole - 9.34"	36407



59000

### King Pin & Gladhand Locks

- Ductile Iron King Pin Lock, Zinc plated.
- Red Nylon Gladhand Lock.
- Supplied with 2 keys.

DESCRIPTION	PART NO.
King Pin Lock	59000
Gladhand Lock	59001



59001

**NOTE:** These locks were designed as a deterrent against tractor and trailer hook-up. They are not warranted to be anti-theft devices for cargo or trailer.

## Premium Aluminum Gladhand

- Plated finish for durability.
- Clamp plate wraps around for extra security.
- To order with filter, add prefix "F" in front of the desired part number.
- Add the suffix "P" for powder coated body & stainless steel clamp.
- Add the suffix "U" for urethane seal.

DESCRIPTION	PART NO.
Service	36101
Emergency	36201
Universal	36301



## Standard Aluminum Gladhand

- Standard Burnished Aluminum Finish
- Clamp plate wraps around for extra security.
- To order with filter, add prefix "F" in front of the desired part number.

DESCRIPTION	PART NO.
Service	56101
Emergency	56201
Universal	56301



## Cast Iron Gladhand

- Zinc Plated and yellow dichromated.
- To order with filter, add prefix "F" in front of the desired part number.
- Polyurethane seal is standard with this assembly.

DESCRIPTION	PART NO.
Service	56121
Emergency	56221
Universal	56321



### Tramec

#### Brake Hose End Kits

#### Brake Hose Fittings

#### Brake Hoses

#### Coiled Air, Push to Connect Fittings

#### Push to Connect Fittings

#### Bulkhead Fittings

#### Reusable Hose Fittings

#### Pogo Stick & Accessories

#### Clamps & Suspenders

#### Springs, Spacers, Clips

#### Gladhand Seals & Accessories, Locks

#### Gladhands

#### Swivel Gladhands & Accessories

#### Gladhands: Swivel, Bracket, Shutoff

#### Drain Valves, Safety Valves

#### Quick Release Valves

#### Spring Brake Valves

#### SONOGRIP® Cables

#### 7-Way Cables / Zinc Plugs

#### Bulk Cable, 30-Pin 7-Way Receptacles

#### 7-Way Receptacles

#### 7-Way Receptacles & Adapter Boxes

#### Smart Box® 7-Way Receptacles

#### Small Nylon 7-Way Receptacles

#### Over Molded 7-Way Receptacles

#### Zinc 7-Way Receptacles & Boxes

#### 7-Way Lid Kits & Parts, Nylon 4-Way

#### Breakers, Zinc 7-Way Plugs and Sockets

#### Single Pole, 4&6-Way Plugs & Sockets

#### Switches

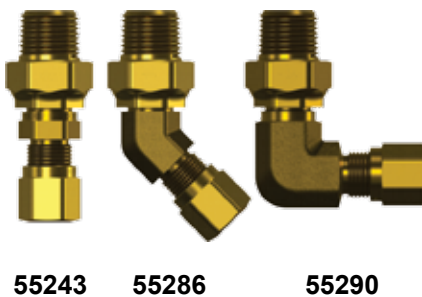
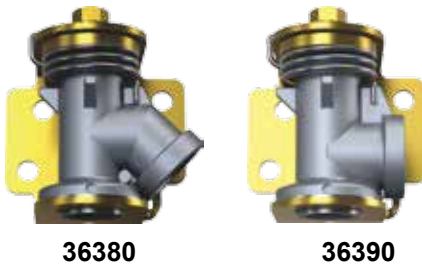
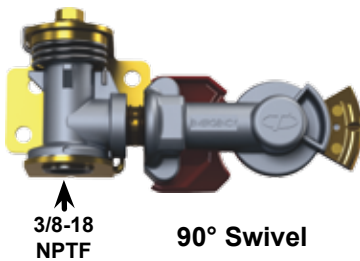
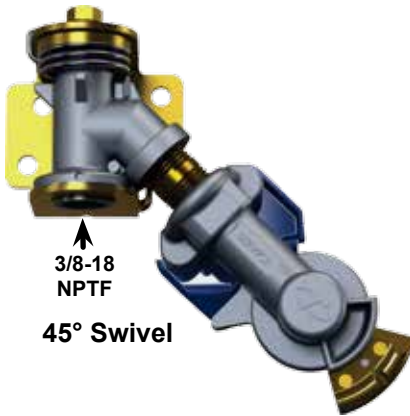

### Aluminum Swivel Gladhands

- Aluminum swivel gladhand with stainless wear pad.
- Stainless Steel Spring.
- Steel mounting bracket zinc plated with yellow dichromate.
- Hardware zinc plated with yellow dichromate.
- Aluminum or Cast Iron Gladhand on Heavy Brass Nipple.
- Add the suffix "P" to anodized part numbers for powder coated body and stainless steel clamp.
- For filters with aluminum gladhands add the prefix "F".
- Add the suffix "U" for urethane gladhand seal.

DESCRIPTION	PART NO. Aluminum Gladhand	PART NO. Anodized Gladhand	PART NO. Cast Iron Gladhand
45° Service	56181	36181	36182
45° Emergency	56281	36281	36282
45° Swivel Mount Only	36380		
90° Service	56191	36191	36192
90° Emergency	56291	36291	36292
90° Swivel Mount Only	36390		
1.5" Heavy Brass Nipple	3638005		
1.12" Heavy Brass Nipple	3638006		

### Swivel Stopper Arms

Accessory Arms for TRAMEC Swivel Gladhands provide a neoprene cover for the face of the gladhand seal when the trailer is parked. Arms share mounting bolts with the swivel mount.

DESCRIPTION	PART NO.
Arm for 45° Swivel Mount	36385
Arm for 90° Swivel Mount	36395

### Swivel Tubing Adapters

Brass swivel adapters convert 3/8 NPTF to nylon air brake connectors for both 3/8" and 1/2" O.D. to prevent twisting the tubing.

- Add Prefix "P" for pre-coated pipe threads.

DESCRIPTION	TUBING	PART NO.
Straight Swivel Fitting	3/8" O.D.	55243
Straight Swivel Fitting	1/2" O.D.	55244
45° Swivel Fitting	3/8" O.D.	55286
45° Swivel Fitting	1/2" O.D.	55287
90° Swivel Fitting	3/8" O.D.	55290
90° Swivel Fitting	1/2" O.D.	55291

### Swivel Gladhand

- Cast iron body, zinc plated with yellow dichromate.
- Mounting holes: Two .34" dia. (1" vertical 1/4" offset).
- Stainless steel return spring.
- To order with filter, add prefix "F" in front of the desired part number.
- Add the suffix "U" for urethane seal.

DESCRIPTION	PART NO.
Service	36131
Emergency	36231
Service Gladhand with Blue Painted Body	36131P
Emergency Gladhand with Red Painted Body	36231P
Filter for Iron Swivel	3600024



### 38° Bracket Mount Gladhand

- Two 3/8" pipe thread ports (one plug furnished).
- Available in plated or plain finish.
- Mounting holes: Two .34" dia. (1" vertical, 1/4" offset).
- To order with filter, add prefix "F" in front of the desired part number.
- Available with powder coated body and stainless clamp
- Add the suffix "U" for urethane seal.

DESCRIPTION	Plated	Powder Coat	Plain
Service	36161	36161P (Blue)	56161
Emergency	36261	36261P (Red)	56261

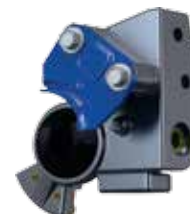
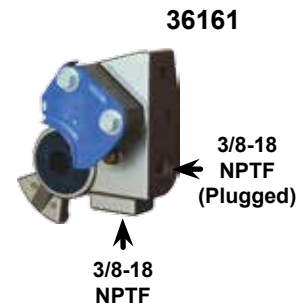

56161

### Shutoff Gladhand

- Impregnated Aluminum body.
- Plated body and handle for better corrosion resistance.
- Includes 1"-14 mounting stud terminating in nylon tubing compression fitting.
- Emergency gladhand has 1/4" NPT port for pintle hook.
- To order with filter, add prefix "F" in front of the desired part number.
- Add the suffix "U" for urethane seal.

DESCRIPTION	NYLON TUBE	PART NO.
Service	3/8" O.D.	36153
Emergency	3/8" O.D.	36253
Service	1/2" O.D.	36154
Emergency	1/2" O.D.	36254
Service	3/8"-18	36156
Emergency	NPTF	36256
Knob Replacement Kit		36159



36153 Shown

#### Tramec

##### Brake Hose End Kits

##### Brake Hose Fittings

##### Brake Hoses

##### Coiled Air, Push to Connect Fittings

##### Push to Connect Fittings

##### Bulkhead Fittings

##### Reusable Hose Fittings

##### Pogo Stick & Accessories

##### Clamps & Suspenders

##### Springs, Spacers, Clips

##### Gladhand Seals & Accessories, Locks

##### Gladhands

##### Swivel Gladhands & Accessories

##### Gladhands: Swivel, Bracket, Shutoff

##### Drain Valves, Safety Valves

##### Quick Release Valves

##### Spring Brake Valves

##### SONOGRIP® Cables

##### 7-Way Cables / Zinc Plugs

##### Bulk Cable, 30-Pin 7-Way Receptacles

##### 7-Way Receptacles

##### 7-Way Receptacles & Adapter Boxes

##### Smart Box® 7-Way Receptacles

##### Small Nylon 7-Way Receptacles

##### Over Molded 7-Way Receptacles

##### Zinc 7-Way Receptacles & Boxes

##### 7-Way Lid Kits & Parts, Nylon 4-Way

##### Breakers, Zinc 7-Way Plugs and Sockets

##### Single Pole, 4&6-Way Plugs & Sockets

##### Switches



**35000**  
Low Profile  
Valve



**35013**  
Kit



**35007**  
Standard Valve  
For 1/8" Cable



**Long Body**  
(Shallow Installation)



**Short Body**  
(Low Profile)

## Remote Control Drain Valve

- Brass Body and stainless steel spring.
- Steel cable, nylon coated, certified to 200 lbs. pull test.
- Low profile to minimize accidental hits and damages.
- Pipe thread 1/4" NPTF.
- To order pre-coated pipe threads, add prefix "P" to the part number.

DESCRIPTION	LOW PROFILE PART NO.	STANDARD PART NO.
Valve Only	35000	35007
Valve & 48" Cable - Assembled	35002-048	35007-048
Valve & 60" Cable - Assembled	35002-060	35007-060
Valve & Unclinched Cable With Loose Clip	35013	35007U060
Cable Only	35001-064	C8016
Aluminum Clip	35008	35017

- Low Profile Valve with Adapter for Heavy Cable

DESCRIPTION	PART NO.
Valve & 48" Cable — Assembled	35006-048
Valve & 60" Cable — Assembled	35006-060

## Pressure Relief Valve, 150 PSI

- Brass Body and stainless steel spring.
- Choice of low profile (air tank) or shallow (tee) installation.
- To order pre-coated pipe threads add prefix "P" to the corresponding part number.

DESCRIPTION	PART NO.
1/4" NPTF, short body valve	35901
3/8" NPTF, short body valve	35903
1/2" NPTF, short body valve	35909

DESCRIPTION	PART NO.
1/4" NPTF, long body valve	35905
3/8" NPTF, long body valve	35907

### Quick Release Valves

- Aluminum Die Cast Body.
- Crack Pressure 0 - 0.5 psi

SUPPLY NPTF	DELIVERY NPTF	PART NO.
3/8"	1/4" x 1/4"	51100
1/2"	1/4" x 1/4"	51101
1/2"	3/8" x 3/8"	51102
3/8"	3/8" x 3/8"	51103
1/4"	1/4" x 1/4"	51104
Repair Kit (O-Ring & Diaphragm)		51110



51103 Shown

### Quick Release Valves For Air Ride Axles

SUPPLY NPTF	DELIVERY NPTF	PART NO.
1/2"	3/8" X 3/8"	51142
3/8"	3/8" X 3/8"	51143
Repair Kit (O-Ring & Diaphragm for Air Ride)		51140

With extended life diaphragm for the heavy duty needs of air ride axles (yellow cover)

### Quick Release Valves

- Exhaust Port Tapped 1/2"-14 NPTF

SUPPLY NPTF	DELIVERY NPTF (2)	EXHAUST NPTF	PART NO. 0 PSI CRACK
1/2"	3/8" x 3/8"	1/2"	51106
3/8"	3/8" x 3/8"	1/2"	51107



51106 Shown

### In-Line Quick Release Valve

FRAME FITTING	DELIVERY	INPUT	PART NO.
NONE	1/2" NPTF	1/4" NPTF	51155
3/4"	1/4" NPTF	1/4" NPTF	51156
7/8"	3/8" NPTF	1/4" NPTF	51157
1"	3/8" NPTF	1/4" NPTF	51158

Available with 90° inlet, contact factory for details.



51157 Shown

#### Tramec

- Brake Hose End Kits
- Brake Hose Fittings
- Brake Hoses
- Coiled Air, Push to Connect Fittings
- Push to Connect Fittings
- Bulkhead Fittings
- Reusable Hose Fittings
- Pogo Stick & Accessories
- Clamps & Suspenders
- Springs, Spacers, Clips
- Gladhand Seals & Accessories, Locks
- Gladhands
- Swivel Gladhands & Accessories
- Gladhands: Swivel, Bracket, Shutoff
- Drain Valves, Safety Valves
- Quick Release Valves
- Spring Brake Valves
- SONOGRIP® Cables
- 7-Way Cables / Zinc Plugs
- Bulk Cable, 30-Pin 7-Way Receptacles
- 7-Way Receptacles
- 7-Way Receptacles & Adapter Boxes
- Smart Box® 7-Way Receptacles
- Small Nylon 7-Way Receptacles
- Over Molded 7-Way Receptacles
- Zinc 7-Way Receptacles & Boxes
- 7-Way Lid Kits & Parts, Nylon 4-Way
- Breakers, Zinc 7-Way Plugs and Sockets
- Single Pole, 4&6-Way Plugs & Sockets
- Switches





**TEV  
VALVE**

### Trailer Spring Brake Valves

TRAMEC Spring Brake Valves (TEV & STEV Valves) provide trailer spring brake control and gladhand pressure protection as required by DOT 121.

- Prevent Spring Brake Drag
- Use a Single Air Tank — allows the elimination of the protected reservoir
- Small Size is Gentle on Tanks, weigh less than two pounds
- Easy Installation & Conversion from Old Systems
- Fully Compatible with Anti-Lock Systems



Bottom View  
(Both Valves)

### TRAILER EMERGENCY VALVE (TEV)

#### Provides Spring Brake Priority

For Direct Control of Trailer Spring Brakes

The logic of the TEV valve retains the ability of the driver to repeatedly apply and release the Parking/Emergency brakes, even with a damaged tank

DESCRIPTION	PART NO.
TEV Valve Assembly	51301
TEV Valve Rebuild Kit	51305

### SENSING TRAILER EMERGENCY VALVE (STEV)

#### Provides Service Brake Priority

To Assure Adequate Supply Is Available from the Tractor

The logic of the STEV valve assures that the trailer parking brakes will not release before there is sufficient air pressure in the reservoir to apply service brakes.

DESCRIPTION	PART NO.
STEV Valve Assembly	51321
STEV Valve Rebuild Kit	51325



**STEV  
VALVE**

Contact the factory for a detailed brochure.

See Cross Reference for Competitive Replacements.

## SONOGRIP® 7-WAY PLUGS

### TRAMEC's Patented 7-Way Cable Plugs

1. Stainless steel radial springs and split terminals provide the best long-term connection to receptacle pins.
2. UltraSONIC welding of terminals eliminates corrosion and loosening at the terminal to wire connection.
3. Solid molded elastomeric body and sealants exclude moisture
4. Reinforced Nylon Sleeve provides durability.



## SONOGRIP® ABS Heavy Duty Cables

- Our Heavy Duty Urethane XT jacketed cable provides Superior Cut, Tear, and Abrasion resistance
- Provides Excellent Coil Memory retention, even at high temperatures
- Coils Remain Flexible at sub-zero temperatures

### SONOGRIP® ABS 1/8 - 2/10 - 4/12 Coiled Cables

PLUG STYLE	PART NUMBER	
	JACKET TYPE	
	"XT" URETHANE	STANDARD
Trailer End   Tractor End	GREEN	GREEN
Straight   Straight	4ACXX	4DCXX
Angle   Straight	4ADXX	4DDXX
Straight   #10 Eyelets	4AJXX	4DJXX
Angle   #10 Eyelets	4AKXX	4DKXX

To get the complete part number for the coil you require, replace "XX" with the number below that describes your cable.

XX	
10	10' Working Length, Two 12" Leads
12	12' Working Length, Two 12" Leads
13	12' Working Length, One 12" Lead & One 72" Lead
14	12' Working Length, One 12" Lead & One 48" Lead
15	15' Working Length, Two 12" Leads
16	15' Working Length, One 12" Lead & One 72" Lead
17	15' Working Length, One 12" Lead & One 48" Lead

### SONOGRIP® ABS 1/8 - 2/10 - 4/12 Straight Cables

PLUG STYLE	PART NUMBER	
	JACKET TYPE	
	"XT" URETHANE	STANDARD
Trailer End   Tractor End	GREEN	GREEN
Straight   Straight	4BCXX	4CCXX
Angle   Straight	4BDXX	4CDXX
Straight   #10 Eyelets	4BJXX	4CJXX
Angle   #10 Eyelets	4BKXX	4CKXX

To get the complete part number, replace "XX" with the over all length in feet



4AD12



4BC12

#### Tramec

Brake Hose End Kits

Brake Hose Fittings

Brake Hoses

Coiled Air, Push to Connect Fittings

Push to Connect Fittings

Bulkhead Fittings

Reusable Hose Fittings

Pogo Stick & Accessories

Clamps & Suspenders

Springs, Spacers, Clips

Gladhand Seals & Accessories, Locks

Gladhands

Swivel Gladhands & Accessories

Gladhands: Swivel, Bracket, Shutoff

Drain Valves, Safety Valves

Quick Release Valves

Spring Brake Valves

SONOGRIP® Cables

7-Way Cables / Zinc Plugs

Bulk Cable, 30-Pin 7-Way Receptacles

7-Way Receptacles

7-Way Receptacles & Adapter Boxes

Smart Box® 7-Way Receptacles

Small Nylon 7-Way Receptacles

Over Molded 7-Way Receptacles

Zinc 7-Way Receptacles & Boxes

7-Way Lid Kits & Parts, Nylon 4-Way

Breakers, Zinc 7-Way Plugs and Sockets

Single Pole, 4&6-Way Plugs & Sockets

Switches



### SONOGRIP® 7-WAY PLUGS

#### TRAMEC's Patented 7-Way Cable Plugs

1. Stainless steel radial springs and split terminals provide the best long-term connection to receptacle pins.
2. UltraSONIC welding of terminals eliminates corrosion and loosening at the terminal to wire connection.
3. Solid molded elastomeric body and sealants exclude moisture
4. Die cast sleeve provides durability.

### SONOGRIP® ABS Heavy Duty Cables

- Our Heavy Duty Urethane XT jacketed cable provides Superior Cut, Tear, and Abrasion resistance
- Provides Excellent Coil Memory retention, even at high temperatures
- Coils Remain Flexible at sub-zero temperatures

### SONOGRIP® ABS 1/8 - 2/10 - 4/12 Coiled Cables

PLUG STYLE	PART NUMBER	
	JACKET TYPE	
	"XT" URETHANE	STANDARD
Trailer End   Tractor End	GREEN	GREEN
Straight   Straight	4A0XX	4D0XX
Angle   Straight	4A1XX	4D1XX
Straight   #10 Eyelets	4A2XX	4D2XX
Angle   #10 Eyelets	4A3XX	4D3XX

To get the complete part number for the coil you require, replace "XX" with the number below that describes your cable.



4A112

<b>XX</b>	
10	10' Working Length, Two 12" Leads
12	<b>12' Working Length, Two 12" Leads</b>
13	12' Working Length, One 12" Lead & One 72" Lead
14	12' Working Length, One 12" Lead & One 48" Lead
15	<b>15' Working Length, Two 12" Leads</b>
16	15' Working Length, One 12" Lead & One 72" Lead
17	15' Working Length, One 12" Lead & One 48" Lead

### SONOGRIP® ABS 1/8 - 2/10 - 4/12 Straight Cables

PLUG STYLE	PART NUMBER	
	JACKET TYPE	
	"XT" URETHANE	STANDARD
Trailer End   Tractor End	GREEN	GREEN
Straight   Straight	4B0XX	4C0XX
Angle   Straight	4B1XX	4C1XX
Straight   #10 Eyelets	4B2XX	4C2XX
Angle   #10 Eyelets	4B3XX	4C3XX

To get the complete part number, replace "XX" with the over all length in feet



4B012

## SONOGRIP® 7-WAY PLUGS

### TRAMEC's Patented 7-Way Cable Plugs

All styles of SONOGRIP Cables are available with one Straight and one Angled plug to reduce cable stress at the high-mounted receptacle, or with Straight plugs on both ends.

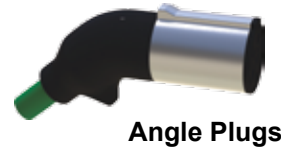

Angle Plugs



Straight Plugs

## SONOGRIP® Standard Cables

- Our Standard jacketed cable provides Good Cut, Tear, and Abrasion resistance, at an Economical Price
- Provides Good Coil Memory retention.
- Coils Remain Flexible at sub-zero temperatures with a -60° Jacket

## SONOGRIP® Standard Coiled Cables

PLUG STYLE	WIRE GAUGES	
	1/10 - 6/12 GA	1/12 - 6/14 GA
Trailer End   Tractor End	BLACK	BLACK
Straight   Straight	450XX	470XX
Angle   Straight	451XX	471XX
Straight   #10 Eyelets	452XX	472XX
Angle   #10 Eyelets	453XX	473XX

To get the complete part number for the coil you require, replace "XX" with the number below that describes your cable.

<b>XX</b>	
10	10' Working Length, Two 12" Leads
12	12' Working Length, Two 12" Leads
13	12' Working Length, One 12" Lead & One 72" Lead
14	12' Working Length, One 12" Lead & One 48" Lead
15	15' Working Length, Two 12" Leads
16	15' Working Length, One 12" Lead & One 72" Lead
17	15' Working Length, One 12" Lead & One 48" Lead



47112



46015

## SONOGRIP® Standard Straight Cables

PLUG STYLE	WIRE GAUGES	
	1/10 - 6/12 GA	1/12 - 6/14 GA
Trailer End   Tractor End	BLACK	BLACK
Straight   Straight	460XX	480XX
Angle   Straight	461XX	481XX
Straight   #10 Eyelets	462XX	482XX
Angle   #10 Eyelets	463XX	483XX

To get the complete part number, replace "XX" with the over all length in feet

### Tramec

Brake Hose End Kits

Brake Hose Fittings

Brake Hoses

Coiled Air, Push to Connect Fittings

Push to Connect Fittings

Bulkhead Fittings

Reusable Hose Fittings

Pogo Stick & Accessories

Clamps & Suspenders

Springs, Spacers, Clips

Gladhand Seals & Accessories, Locks

Gladhands

Swivel Gladhands & Accessories

Gladhands: Swivel, Bracket, Shutoff

Drain Valves, Safety Valves

Quick Release Valves

Spring Brake Valves

### SONOGRIP® Cables

7-Way Cables / Zinc Plugs

Bulk Cable, 30-Pin 7-Way Receptacles

7-Way Receptacles

7-Way Receptacles & Adapter Boxes

Smart Box® 7-Way Receptacles

Small Nylon 7-Way Receptacles

Over Molded 7-Way Receptacles

Zinc 7-Way Receptacles & Boxes

7-Way Lid Kits & Parts, Nylon 4-Way

Breakers, Zinc 7-Way Plugs and Sockets

Single Pole, 4&6-Way Plugs & Sockets

Switches

### ABS Heavy Duty Cables with Metal Plugs

- Our Heavy Duty Urethane **XT** jacketed cable provides Superior Cut, Tear, and Abrasion resistance
- Provides Excellent Coil Memory retention, even at high temperatures
- Coils Remain Flexible at sub-zero temperatures
- Conventional Die Cast Zinc Plugs

### ABS 1/8 - 2/10 - 4/12 Coiled Cables



4DA12

CABLE ENDS	PART NUMBER	
	JACKET TYPE	
Trailer End   Tractor End	"XT" URETHANE GREEN	STANDARD GREEN
7-Way Plug   7-Way Plug	4AAXX	4DAXX
7-Way Plug   #10 Eyelets	4ABXX	4DBXX

To get the complete part number for the coil you require, replace "XX" with the number below that describes your cable.

<b>XX</b>	
10	10' Working Length, Two 12" Leads
12	<b>12' Working Length, Two 12" Leads</b>
13	12' Working Length, One 12" Lead & One 72" Lead
14	12' Working Length, One 12" Lead & One 48" Lead
15	<b>15' Working Length, Two 12" Leads</b>
16	15' Working Length, One 12" Lead & One 72" Lead
17	15' Working Length, One 12" Lead & One 48" Lead

### ABS 1/8 - 2/10 - 4/12 Straight Cables



4CA12

CABLE ENDS	PART NUMBER	
	JACKET TYPE	
Trailer End   Tractor End	"XT" URETHANE GREEN	STANDARD GREEN
7-Way Plug   7-Way Plug	4BAXX	4CAXX
7-Way Plug   #10 Eyelets	4BBXX	4CBXX

To get the complete part number, replace "XX" with the over all length in feet

## Standard Cables with Metal Plugs

- Our Standard jacketed cable provides Good Cut, Tear, and Abrasion resistance, at an Economical Price
- Provides Good Coil Memory retention.
- Coils Remain Flexible at sub-zero temperatures with a -60° Jacket
- Conventional Die Cast Zinc Plugs

## Standard Coiled Cables

CABLE ENDS	WIRE GAUGES	
	1/10 - 6/12 GA	1/12 - 6/14 GA
Trailer End   Tractor End	BLACK	BLACK
7-Way Plug   7-Way Plug	45AXX	47AXX
7-Way Plug   #10 Eyelets	45BXX	47BXX

To get the complete part number for the coil you require, replace "XX" with the number below that describes your cable.

<b>XX</b>	
10	10' Working Length, Two 12" Leads
12	<b>12' Working Length, Two 12" Leads</b>
13	12' Working Length, One 12" Lead & One 72" Lead
14	12' Working Length, One 12" Lead & One 48" Lead
15	<b>15' Working Length, Two 12" Leads</b>
16	15' Working Length, One 12" Lead & One 72" Lead
17	15' Working Length, One 12" Lead & One 48" Lead



45A12

## Standard Straight Cables

CABLE ENDS	WIRE GAUGES	
	1/10 - 6/12 GA	1/12 - 6/14 GA
Trailer End   Tractor End	BLACK	BLACK
7-Way Plug   7-Way Plug	46AXX	48AXX
7-Way Plug   #10 Eyelets	46BXX	48BXX

To get the complete part number, replace "XX" with the over all length in feet



46A12

### Tramec

Brake Hose End Kits

Brake Hose Fittings

Brake Hoses

Coiled Air, Push to Connect Fittings

Push to Connect Fittings

Bulkhead Fittings

Reusable Hose Fittings

Pogo Stick & Accessories

Clamps & Suspenders

Springs, Spacers, Clips

Gladhand Seals & Accessories, Locks

Gladhands

Swivel Gladhands & Accessories

Gladhands: Swivel, Bracket, Shutoff

Drain Valves, Safety Valves

Quick Release Valves

Spring Brake Valves

SONOGRIP® Cables

7-Way Cables / Zinc Plugs

Bulk Cable, 30-Pin 7-Way Receptacles

7-Way Receptacles

7-Way Receptacles & Adapter Boxes

Smart Box® 7-Way Receptacles

Small Nylon 7-Way Receptacles

Over Molded 7-Way Receptacles

Zinc 7-Way Receptacles & Boxes

7-Way Lid Kits & Parts, Nylon 4-Way

Breakers, Zinc 7-Way Plugs and Sockets

Single Pole, 4&6-Way Plugs & Sockets

Switches

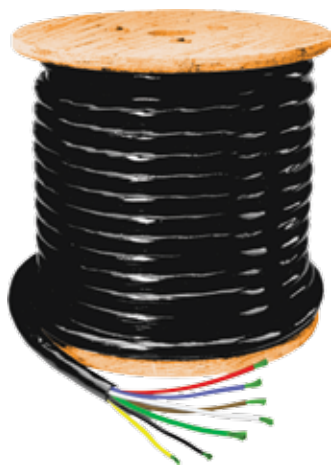

Trailer Cable

### Trailer Cable

- High Quality -60°F to +190°F Temperature Range
- High Strand Count for Flexibility
- Insulation Conforms to SAE J1128 for GPT Wire

DESCRIPTION	PART NO.
6-Conductor - 14 ga.	OCTR009XX
7-Conductor - (6 - 12 ga., 1 - 10 ga.)	05511XX
7-Conductor - (6 - 14 ga. 1 - 12 ga.)	05545XX
7-Conductor - (4 - 12 ga., 2 - 10 ga., 1 - 8 ga.)*	OCT2023XX

XX= Coil Size: 01=100 ft., 05=500 ft.

\* OCT2023XX is an "ABS" Cable, per SAE J2394 Type F  
Copper Content is >10% Higher than SAE J1128 Requirements  
High Strand Count and -60° F Green Jacket for Flexibility



Nylon Receptacle & 4" Deep Nylon Box

### 30-Pin Nylon 7-Way Receptacle Systems

- SAE J560 Nylon Style Receptacles & Box
- 30 Push-On Style Ø.180 Terminals
- Made of non-corrosive, reinforced Nylon.
- For chassis ground option, add suffix "G"
- Kits include Gasket, Grommet, and Receptacle Mounting Screws
- Kits do not include box mounting hardware

RECEPTACLES WITH STANDARD 4" ADAPTER BOXES	SOLID PIN PART NO.	SPLIT PIN PART NO.
Receptacle Only	38304	38305
Receptacle w/ 4" Adapter Box	38306	38307

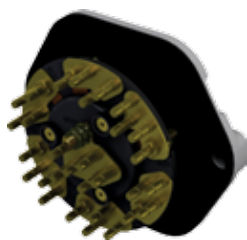

Nylon or Zinc 30-Pin Receptacles have six Ø.180 Push-On's plus one #10 terminal at White; the Brown, Green, Red, Yellow, Black, and Blue circuits each have four Ø.180 Push-On's plus one #10 terminal



Zinc Receptacle & 3" Deep Zinc Box

### 30-Pin Zinc 7-Way Receptacle Systems

- SAE J560 Zinc Style Receptacles & Box
- 30 Push-On Style Ø.180 Terminals
- Kits include Gasket, Grommet, and Receptacle Mounting Screws
- Kits do not include box mounting hardware

RECEPTACLES WITH STANDARD 3" ADAPTER BOXES	SOLID PIN PART NO.	SPLIT PIN PART NO.
Receptacle Only	38844	38845
Receptacle w/ 3" Adapter Box	38848	38849

## Seven Way Receptacle Systems

- SAE J560 Style Receptacles
- Made of non-corrosive, reinforced Nylon.
- TRAMEC Nylon Receptacles feature a direct wired ground for the safest possible connections.
- TRAMEC recommends ring terminals for the connection between wires and receptacle pins for positive mechanical connections.

DESCRIPTION RECEPTACLES WITHOUT BOXES	SOLID PIN PART NO.	SPLIT PIN PART NO.
Large Flange with Screw Terminals	38200	38202
Receptacle w/ 15A Circuit Breakers	38210	38211
Receptacle w/ 20A Circuit Breakers	38212	38213
Receptacle w/ 30A Circuit Breakers	38214	38215
Receptacle w/ 40A Circuit Breakers	38216	38217
Receptacle with Stacking Studs	38360	38361
Receptacle with Push-On Terminals	38310	38312

## Seven Way Receptacle Systems

- SAE J560 Nylon Style Receptacles & Box
- Made of non-corrosive, reinforced Nylon.
- Back Side of Boxes Closed Against Mounting Surface
- For Harness Entry from Back, add suffix "B"
- For chassis ground option, add suffix "G"

RECEPTACLES WITH STANDARD 2" ADAPTER BOXES	SOLID PIN PART NO.	SPLIT PIN PART NO.
Receptacle with Stacking Studs	38350	38351
Receptacle w/ 15A Circuit Breakers	38340	38341
Receptacle w/ 20A Circuit Breakers	38342	38343
Receptacle w/ 30A Circuit Breakers	38344	38345

RECEPTACLES WITH STANDARD 3" ADAPTER BOXES	SOLID PIN PART NO.	SPLIT PIN PART NO.
Receptacle with Stacking Studs	38450	38451
Receptacle w/ 15A Circuit Breakers	38440	38441
Receptacle w/ 20A Circuit Breakers	38442	38443
Receptacle w/ 30A Circuit Breakers	38444	38445



Screw Terminals  
38200 Shown



Circuit Breakers  
38210 Shown



Six Stacking Studs  
("Junction Box" Use)  
38360 Shown



Push-On Terminals  
38310 Shown



38350



38450

### Tramec

Brake Hose End Kits

Brake Hose Fittings

Brake Hoses

Coiled Air, Push to  
Connect Fittings

Push to Connect  
Fittings

Bulkhead Fittings

Reusable Hose  
Fittings

Pogo Stick &  
Accessories

Clamps & Suspenders

Springs, Spacers,  
Clips

Gladhand Seals &  
Accessories, Locks

Gladhands

Swivel Gladhands  
& Accessories

Gladhands: Swivel,  
Bracket, Shutoff

Drain Valves, Safety  
Valves

Quick Release Valves

Spring Brake Valves

SONOGRIP® Cables

7-Way Cables / Zinc  
Plugs

Bulk Cable, 30-Pin  
7-Way Receptacles

7-Way Receptacles

7-Way Receptacles  
& Adapter Boxes

Smart Box® 7-Way  
Receptacles

Small Nylon 7-Way  
Receptacles

Over Molded 7-Way  
Receptacles

Zinc 7-Way  
Receptacles & Boxes

7-Way Lid Kits &  
Parts, Nylon 4-Way

Breakers, Zinc 7-Way  
Plugs and Sockets

Single Pole, 4&6-Way  
Plugs & Sockets

Switches





Receptacle & 4" Deep Nylon Boxes

### Seven Way Receptacle Systems

- SAE J560 Nylon Style Receptacles & Box
- Made of non-corrosive, reinforced Nylon.
- For chassis ground option, add suffix "G"

RECEPTACLES WITH STANDARD 4" ADAPTER BOXES	SOLID PIN PART NO.	SPLIT PIN PART NO.
Receptacle with Stacking Studs	38452	38453
Receptacle w/ 15A Circuit Breakers	38460	38461
Receptacle w/ 20A Circuit Breakers	38462	38463
Receptacle w/ 30A Circuit Breakers	38464	38465



4" Deep Nylon Adapter Boxes  
3826040

### 4" Surface Mounted Adapter Boxes

- Adapter Box of Reinforced Nylon
- Double Wire Harness Entry from Bottom
- Back Side of Box Is Open, Gasket Included

DESCRIPTION	PART NO.
4" Deep Nylon Adapter Box	3826040



Deep and Shallow Adapter Boxes  
38265 Shown

### Surface Mounted Adapter Boxes

- Adapter Boxes of Reinforced Nylon Available as Deep or Shallow
- Back Side of Boxes of Reinforced Nylon
- Wire Harness Entry Available from Bottom or Back
- For self grounding box, add the suffix "G" to the part number.

DESCRIPTION	BOTTOM ENTRY PART NO.	BACK ENTRY PART NO.
Deep Style — 3" inside depth	3826035	3826035B
Standard Style — 2" inside depth	38265	38265B
Shallow Style — 1" inside depth	38260	38260B
Adapter for Small 2 Hole Recepts.	3826022-1	



3826022-1  
Adapter for Small Receptacle

## SMART BOX<sup>®</sup> CONNECTOR (38520 Shown)



3850031  
SMART BOX  
Adapter

### Fleet Friendly J560 Receptacle

- No Need to Disturb Wiring When Replacing the Receptacle
- Available as Standard J560 or Auxiliary (ISO Style)
- Receptacle Simply Plugs In and Secures with Two Nuts
- Fits Standard Mounting Bolt Pattern (Box with Cover is 2-1/4" Deep)
- Two Cable Entry Grommets
- #10 Studs Provide Capacity for Multiple Terminals
- Wiring Remains Stationary On Studs Inside the Box
- Brass Jumpers Bridge From the Studs to the Receptacle Pins
- Stainless Steel Springs Around the Terminals Grip the Pins



38501  
Receptacle



38707  
Receptacle  
(ISO Style)

DESCRIPTION	SOLID PIN PART NO.	SPLIT PIN PART NO.
Box & Receptacle - Surface Mount	38520	38521
Box & Receptacle - Recessed Mount	38526	38527
Replacement Receptacle	38501	38502
Box & Receptacle - ISO Style	38720	
Replacement Receptacle - ISO Style	38707	
Adapter Box Only - Surface Mount	3850031	
Adapter Box Only - Recessed Mount	3850041	
Box Kit - Surface Mount	3850032	
Box Kit - Recessed Mount	3850042	
Cover Gasket	3850008	
Anodized Aluminum Cover Plate	3850015	

- Recessed mount boxes hold square-neck bolts from the back for mounting on adapter plates.
- Box Kits 3850032 & 3850042 include box, 3850008 gasket, 3850015 aluminum cover plate, and two each 3826004 grommets, 3826021 bolts & 3826020 nuts.



3850015



3850008

#### Tramec

Brake Hose End Kits

Brake Hose Fittings

Brake Hoses

Coiled Air, Push to Connect Fittings

Push to Connect Fittings

Bulkhead Fittings

Reusable Hose Fittings

Pogo Stick & Accessories

Clamps & Suspenders

Springs, Spacers, Clips

Gladhand Seals & Accessories, Locks

Gladhands

Swivel Gladhands & Accessories

Gladhands: Swivel, Bracket, Shutoff

Drain Valves, Safety Valves

Quick Release Valves

Spring Brake Valves

SONOGRIP<sup>®</sup> Cables

7-Way Cables / Zinc Plugs

Bulk Cable, 30-Pin 7-Way Receptacles

7-Way Receptacles

7-Way Receptacles & Adapter Boxes

Smart Box<sup>®</sup> 7-Way Receptacles

Small Nylon 7-Way Receptacles

Over Molded 7-Way Receptacles

Zinc 7-Way Receptacles & Boxes

7-Way Lid Kits & Parts, Nylon 4-Way

Breakers, Zinc 7-Way Plugs and Sockets

Single Pole, 4&6-Way Plugs & Sockets

Switches

# DUAL SMART BOX

The **Dual Smart Box** provides all the advantages of the **Smart Box** system installation, plus space for junction box use. Instead of attaching all of the wires directly to the J560 receptacle, circuit attachment is stationary in the bottom of the box - connected to a central outlet.

When installing (or replacing) the receptacle, it simply plugs in and secures with two fasteners - the wiring remains connected and undisturbed.

The new Dual Smart Box provides the installation and performance benefits of the original Smart Box with double the interior space for installation for accessory devices. Two double grommets are provided for easy installation of harness leads. The cover is anodized aluminum, mounting nuts and bolts are stainless steel.

The box mounts internally on four 5/16 mounting bolts in the same pattern used for standard adapter boxes. An internal jumper provides for chassis grounding, and may be removed if not needed. Space is provided at the road side of the box and cover for user installed items such as supplemental switches.

Tramec Products



Removable Chassis Ground Jumper

## Dual Smart Box

DESCRIPTION	SOLID PIN PART NO.	SPLIT PIN PART NO.
Dual Smart Box w/ Receptacle	38540	38541



Removable Chassis Ground Jumper

## Jumbo Smart Box

DESCRIPTION	SOLID PIN PART NO.	SPLIT PIN PART NO.
Jumbo Box w/ Receptacle	38560	38561



Removable Chassis Ground Jumper

## Breaker Smart Box

DESCRIPTION	SOLID PIN PART NO.	SPLIT PIN PART NO.
Receptacle w/ 15A Circuit Breakers	38550-15	38551-15
Receptacle w/ 20A Circuit Breakers	38550-20	38551-20
Receptacle w/ 30A Circuit Breakers	38550-30	38551-30

# Smart Box Installation



The box mounts on four 5/16 bolts using the industry standard nose box layout (mounting plate and bolts not included).

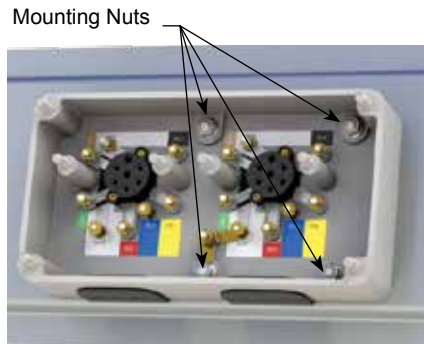

Mounting Nuts

The dual box is mounted using four 5/16" flange nuts or nuts and washers (not included) inside the box. Wiring can now be completed inside the box, without the need to install wiring directly to the back of the socket. No more spaghetti ball to force into the box.



After installing all wiring in the box, assemble the included gasket and anodized aluminum cover plate onto the molded-in bolts, using the included stainless steel flange nuts. The application of a non-conductive (dielectric) grease, per TMC recommended practice RP-155, to receiver sockets and to the rear pins of the receptacle can reduce installation force, and increase life of the connector.



Fully engage rear pins of the receptacles with the receiver in the box using *hand force* to ensure alignment before installing the provided stainless steel flange nuts. Do not use nuts to draw the receptacle pins into the receiver. Misalignment may damage the assembly, and cause poor connections.

## Tramec

**Brake Hose End Kits**

**Brake Hose Fittings**

**Brake Hoses**

**Coiled Air, Push to Connect Fittings**

**Push to Connect Fittings**

**Bulkhead Fittings**

**Reusable Hose Fittings**

**Pogo Stick & Accessories**

**Clamps & Suspenders**

**Springs, Spacers, Clips**

**Gladhand Seals & Accessories, Locks**

**Gladhands**

**Swivel Gladhands & Accessories**

**Gladhands: Swivel, Bracket, Shutoff**

**Drain Valves, Safety Valves**

**Quick Release Valves**

**Spring Brake Valves**

**SONOGRIP® Cables**

**7-Way Cables / Zinc Plugs**

**Bulk Cable, 30-Pin 7-Way Receptacles**

**7-Way Receptacles**

**7-Way Receptacles & Adapter Boxes**

**Smart Box® 7-Way Receptacles**

**Small Nylon 7-Way Receptacles**

**Over Molded 7-Way Receptacles**

**Zinc 7-Way Receptacles & Boxes**

**7-Way Lid Kits & Parts, Nylon 4-Way**

**Breakers, Zinc 7-Way Plugs and Sockets**

**Single Pole, 4&6-Way Plugs & Sockets**

**Switches**

### Small Style Two Hole Mounting

- SAE J560 Style Receptacles
- Made of non-corrosive, reinforced Nylon.



**38282**  
180° Connection

DESCRIPTION RECEPTACLES WITHOUT BOOT	SOLID PIN PART NO.	SPLIT PIN PART NO.
180° Connection Screw Terminals	38282	38283

Includes 3850200 gasket



**38290**  
90° Connection

DESCRIPTION RECEPTACLES WITHOUT BOOT	SOLID PIN PART NO.	SPLIT PIN PART NO.
90° Connection Screw Terminals	38290	38292

Includes 3829002 gasket



**38296**  
Push-On

DESCRIPTION RECEPTACLES WITHOUT BOOT	SOLID PIN PART NO.	SPLIT PIN PART NO.
Push-On Terminals	38296	38298

Includes 3829002 gasket



**38492**  
Wire Insert

DESCRIPTION RECEPTACLES WITHOUT BOOT	SOLID PIN PART NO.	SPLIT PIN PART NO.
Wire Insert Terminals	-	38492

Includes 3829002 gasket



### Receptacles with Boot

RECEPTACLES WITH 382705 END ACCESS BOOT	SOLID PIN PART NO.	SPLIT PIN PART NO.
180° Connection Screw Terminals	38394	38395
Push-On Terminals	38396	38397



**38705**  
( ISO )

### “ISO” Style Two Hole Mounting

- SAE J560 Yellow Auxiliary (ISO 3731 Style) Receptacles
- Made of non-corrosive, reinforced Nylon.

DESCRIPTION Auxiliary (ISO 3731) RECEP	SOLID PIN PART NO.	SPLIT PIN PART NO.
180° Connection Screw Terminals	38705	38706

Includes 3850200 gasket

## Over-Molded Receptacles

- SAE J560 Style Receptacles
- Made of non-corrosive, reinforced Nylon
- Pins insert-molded to seal out moisture & contaminants
- Wire to pin terminations are sealed in an over-molded “boot”
- Over-mold is bonded to receptacle & cable jacket
- Brass pins are plated for long life
- ABS style (SAE J2394) heavy gage cable (1/8 - 2/10 - 4/12 ga)
- Gaskets (3850200) are pre-applied to the mounting flange

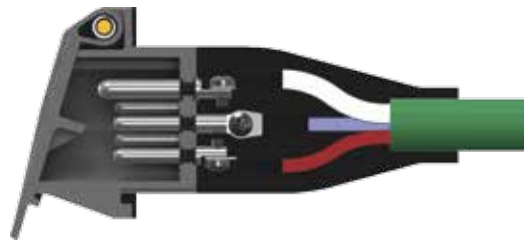

## Standard Style

- SAE J560 Primary Style Receptacles
- Supplied with 48” blunt cut ABS cable

DESCRIPTION	SOLID PIN PART NO.	SPLIT PIN PART NO.
Straight Style Primary J560	38402-04	38403-04
90° Style (6 o'clock) Primary J560	38407-04	38408-04

Consult the factory for custom cable and termination options.

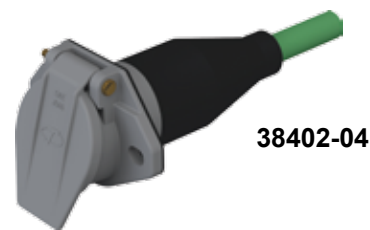

38402-04



38407-04

## “ISO” Style

- SAE J560 Yellow Auxiliary (ISO 3731 Style)
- Supplied with 48” blunt cut ABS cable

DESCRIPTION	SOLID PIN PART NO.
Straight Style Auxiliary Receptacle	38410-04
90° Style (6 o'clock) Auxiliary Receptacle	38412-04

Consult the factory for custom cable and termination options.



38410-04



38412-04

### Tramec

- Brake Hose End Kits
- Brake Hose Fittings
- Brake Hoses
- Coiled Air, Push to Connect Fittings
- Push to Connect Fittings
- Bulkhead Fittings
- Reusable Hose Fittings
- Pogo Stick & Accessories
- Clamps & Suspenders
- Springs, Spacers, Clips
- Gladhand Seals & Accessories, Locks
- Gladhands
- Swivel Gladhands & Accessories
- Gladhands: Swivel, Bracket, Shutoff
- Drain Valves, Safety Valves
- Quick Release Valves
- Spring Brake Valves
- SONOGRIP® Cables
- 7-Way Cables / Zinc Plugs
- Bulk Cable, 30-Pin 7-Way Receptacles
- 7-Way Receptacles
- 7-Way Receptacles & Adapter Boxes
- Smart Box® 7-Way Receptacles
- Small Nylon 7-Way Receptacles
- Over Molded 7-Way Receptacles
- Zinc 7-Way Receptacles & Boxes
- 7-Way Lid Kits & Parts, Nylon 4-Way
- Breakers, Zinc 7-Way Plugs and Sockets
- Single Pole, 4&6-Way Plugs & Sockets
- Switches



38810



38800



38861

38860



38802



38804

### Seven Way Receptacle Systems

- SAE J560 Style Receptacles
- Bodies Made of Die-Cast Zinc with Stainless Hinge Pin & Spring.
- Receptacle Inserts are O-Ring Sealed and Self-Grounding.
- TRAMEC recommends ring terminals for the connection between wires and receptacle pins for positive mechanical connections.
- Receptacle gaskets are included

RECEPTACLES WITHOUT BOXES	SOLID PIN PART NO.	SPLIT PIN PART NO.
Receptacle without Circuit Breakers	38800	38801
Receptacle w/ 15A Circuit Breakers	38810	38811
Receptacle w/ 20A Circuit Breakers	38812	38813
Receptacle w/ 30A Circuit Breakers	38814	38815

### Surface Mounted Adapter Boxes

- Bodies Made of Die-Cast Zinc
- Nominal 2" and 3" depth options fit industry standard hole pattern
- 3" Deep Box has a double grommet
- Kits include Gasket, Grommet, and Receptacle Mounting Screws

DESCRIPTION	2" DEEP PART NO.	3" DEEP PART NO.
Die-Cast Zinc Adapter Box	38860	38861

### Receptacle & Adapter Box Kits

- Kits include Gasket, Grommet, and Receptacle Mounting Screws
- Kits do not include box mounting hardware

RECEPTACLES WITH 2" BOXES	SOLID PIN PART NO.	SPLIT PIN PART NO.
Receptacle without Circuit Breakers	38802	38803
Receptacle w/ 15A Circuit Breakers	38820	38821
Receptacle w/ 20A Circuit Breakers	38822	38823
Receptacle w/ 30A Circuit Breakers	38824	38825

RECEPTACLES WITH 3" BOXES	SOLID PIN PART NO.	SPLIT PIN PART NO.
Receptacle without Circuit Breakers	38804	38805
Receptacle w/ 15A Circuit Breakers	38830	38831
Receptacle w/ 20A Circuit Breakers	38832	38833
Receptacle w/ 30A Circuit Breakers	38834	38835

## Additional Smart Box Accessories

DESCRIPTION	PART NO.
Extension Bolt Kit for Retrofit	3850029
Flange Nut for Receptacle	3826020
Bolt for Receptacle	3826021

- **Extension Bolt Kit 3850029** includes adapters and bolts (4 each) to allow retrofit of Smart Box onto existing short 5/16-18 trailer nose box bolts.

## Lid Kit for All TRAMEC Nylon Receptacles

Should cover damage occur in service, TRAMEC provides an easy-to-install 5-piece replacement kit consisting of: (1) new nylon lid; (2) steel hinge pin; (3) stainless steel spring; (4) shaft retainer; and (5) cotter pin.

DESCRIPTION	PART NO.
Lid Field Service Kit (Gray)	38204
Lid Field Service Kit (Yellow)	38704

## Miscellaneous Receptacle Accessories

DESCRIPTION	PART NO.
Receptacle Boot - End Access	3827005
Large Flange Receptacle Boot - Bottom Access	3820017
Single Grommet for Adapter Box	3826004
Double Grommet for Adapter Box	3826045
Self Adhesive Receptacle Gasket - Large Flange	3820009
Self Adhesive Receptacle Gasket - 2-Hole Mount	3829002
Self Adhesive Receptacle Gasket - 2-Hole Mount	3850200
8" X 10 GA White Jumper, 5/16" & #10 Eyelets	3826015

## Nylon 4-Way Receptacle

- Made of non-corrosive, reinforced Nylon
- Mates with Standard Round 4-Way Plug
- Mounting is the same as metal versions
- Stainless steel hinge pin and spring
- Split Pins with Wire Insert terminals

DESCRIPTION	PART NO.
Nylon 4 - Way Receptacle	38714

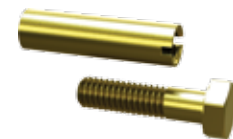

3850029 Extension Adapter Kit



3826021



3826020

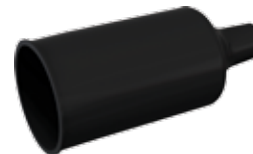

3827005



3826045



3826004



38714

### Tramec

Brake Hose End Kits

Brake Hose Fittings

Brake Hoses

Coiled Air, Push to Connect Fittings

Push to Connect Fittings

Bulkhead Fittings

Reusable Hose Fittings

Pogo Stick & Accessories

Clamps & Suspenders

Springs, Spacers, Clips

Gladhand Seals & Accessories, Locks

Gladhands

Swivel Gladhands & Accessories

Gladhands: Swivel, Bracket, Shutoff

Drain Valves, Safety Valves

Quick Release Valves

Spring Brake Valves

SONOGRIP® Cables

7-Way Cables / Zinc Plugs

Bulk Cable, 30-Pin 7-Way Receptacles

7-Way Receptacles

7-Way Receptacles & Adapter Boxes

Smart Box® 7-Way Receptacles

Small Nylon 7-Way Receptacles

Over Molded 7-Way Receptacles

Zinc 7-Way Receptacles & Boxes

7-Way Lid Kits & Parts, Nylon 4-Way

Breakers, Zinc 7-Way Plugs and Sockets

Single Pole, 4&6-Way Plugs & Sockets

Switches





3822010

### Circuit Breakers

- SAE J553 12 Volt Type I

DESCRIPTION	PART NO.
15 AMP	3822010
20 AMP	3822011
30 AMP	3822012
40 AMP	3822013

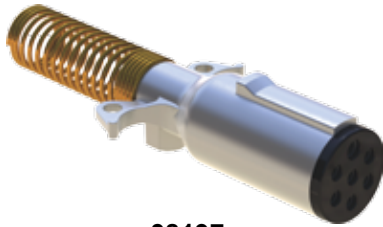

38197

### 7 Way Plugs With Die-Cast Metal Bodies

DESCRIPTION	PART NO.
7-Pole Plug with Spring Guard	38197
7-Pole Plug without Spring Guard	38198

With Wire-Insert Terminals



38497

### 7 Way Receptacles With Die-Cast Bodies

DESCRIPTION	PART NO.
7-Pole Receptacle, with Split Pins	38497

With Wire-Insert Terminals

Wire Insert Terminals

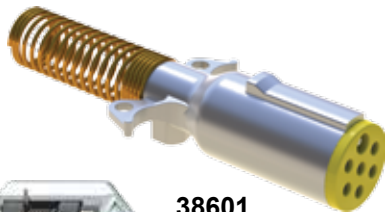

38601

### Auxiliary 7 Way Plugs & Receptacles (ISO 3731)

DESCRIPTION	PART NO.
ISO 7-Pole Plug	38601
ISO 7-Pole Receptacle	38701

With Wire-Insert Terminals



38701

### Boot and Gasket for Die cast 7-Way

DESCRIPTION	PART NO.
Boot for Die Cast 7-Way Receptacle	3849709
Gasket for Zinc 7-Way Receptacle	3870102



3849709



3870102

## Single Pole Plugs and Receptacles

DESCRIPTION	PART NO.
Single Pole Plug Receptacle	38491
Single Pole Plug w/ Spring Guard	38181

Cable Terminals Included



## Single Pole Lift-Gate Cables 4 Ga (1666 Strand) Copper

DESCRIPTION	PART NO.
12' Single Pole Lift-Gate Cable	38181-12
15' Single Pole Lift-Gate Cable	38181-15



## 4 and 6 Way Die Cast Plugs

DESCRIPTION	PART NO.
Four Way Die Cast Plug	38194
Six Way Die Cast Plug w/ Spring Guard	38195
Six Way Die Cast Plug w/o Spring Guard	38196

With Wire-Insert Terminals



## Heavy Duty 4 and 6 Way Receptacles

DESCRIPTION	PART NO.
Four Way Die Cast Receptacle	38494
Six Way Die Cast Receptacle	38496

With Wire-Insert Terminals



## 6 Way Cables (Zinc Plugs 14 ga wire)

DESCRIPTION	PART NO.
8' Six Way Coiled Cable w/ Spring Guard	38196-08
10' Six Way Coiled Cable w/ Spring Guard	38196-10
12' Six Way Coiled Cable w/ Spring Guard	38196-12
15' Six Way Coiled Cable w/ Spring Guard	38196-15



### Tramec

- Brake Hose End Kits
- Brake Hose Fittings
- Brake Hoses
- Coiled Air, Push to Connect Fittings
- Push to Connect Fittings
- Bulkhead Fittings
- Reusable Hose Fittings
- Pogo Stick & Accessories
- Clamps & Suspenders
- Springs, Spacers, Clips
- Gladhand Seals & Accessories, Locks
- Gladhands
- Swivel Gladhands & Accessories
- Gladhands: Swivel, Bracket, Shutoff
- Drain Valves, Safety Valves
- Quick Release Valves
- Spring Brake Valves
- SONOGRIP® Cables
- 7-Way Cables / Zinc Plugs
- Bulk Cable, 30-Pin 7-Way Receptacles
- 7-Way Receptacles
- 7-Way Receptacles & Adapter Boxes
- Smart Box® 7-Way Receptacles
- Small Nylon 7-Way Receptacles
- Over Molded 7-Way Receptacles
- Zinc 7-Way Receptacles & Boxes
- 7-Way Lid Kits & Parts, Nylon 4-Way
- Breakers, Zinc 7-Way Plugs and Sockets
- Single Pole, 4 & 6-Way Plugs & Sockets
- Switches

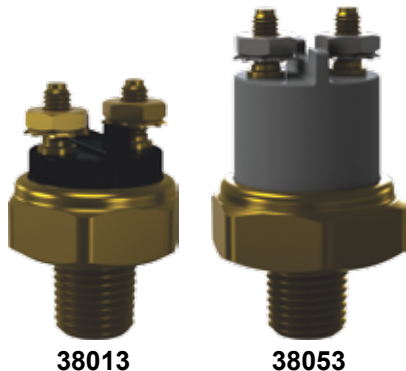

### Stop Light Switch

- Meets the requirements of DOT 121
- Brass body resists corrosion
- Rated at a full 24 Amp Load, 12 Volt
- Silver and cadmium contacts for long life and low voltage drop
- Installs with a deep socket
- 1/4"-18 NPTF
- Add Prefix "P" for pre-coated pipe threads

DESCRIPTION	PART NO.
Stop Light Switch	38013
Sealed Stop Light Switch	38053

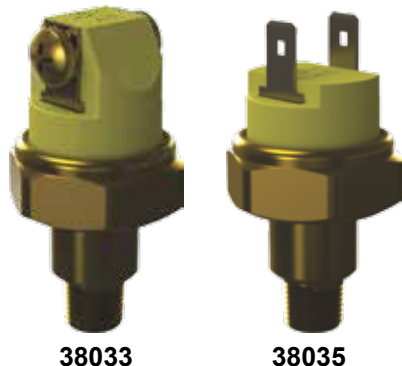

### Low Pressure Warning

- Closes at 60 PSI descending pressure
- Brass Body Resists Corrosion
- Rated at 5 amps, 12 volt
- Color Coded — Yellow
- Installs with a deep socket
- 1/8"-27 NPTF
- Add prefix "P" for pre-coated pipe threads

DESCRIPTION	PART NO.
LP Warning Switch, screw terminals	38033
LP Warning Switch, blade terminals	38035

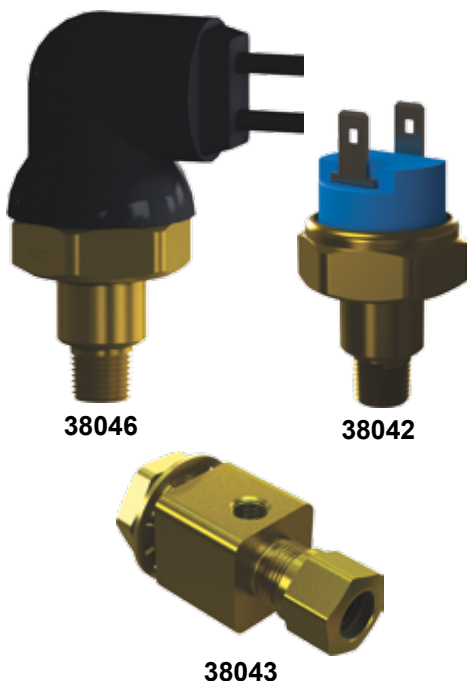

### ABS Accessory Switch

- Allows Sharing of the Blue Circuit
- Ensures Full Capacity of Blue Circuit is Delivered to ABS Unit When Vehicle is Rolling Down the Road
- Allows Accessories, that are not needed when driving, to share the Blue Circuit - Rated at 15 Amps, 12 Volt
- 1/8"-27 NPTF

DESCRIPTION	PART NO.
Switch without Boot (.25 Slide Terminals)	38042
Switch with Boot (12 ga. x 24" Wire Leads)	38046
Anchor Tee for ABS Switch, for 1/2" Tubing	38043
Anchor Tee for ABS Switch, for 3/8" Tubing	38044

- 38042 may only be used inside a weather-tight enclosure
- If 38046 is installed exposed to the weather, be sure to use a sealed connection



<b>Tramec</b>
<b>Brake Hose End Kits</b>
<b>Brake Hose Fittings</b>
<b>Brake Hoses</b>
<b>Coiled Air, Push to Connect Fittings</b>
<b>Push to Connect Fittings</b>
<b>Bulkhead Fittings</b>
<b>Reusable Hose Fittings</b>
<b>Pogo Stick &amp; Accessories</b>
<b>Clamps &amp; Suspenders</b>
<b>Springs, Spacers, Clips</b>
<b>Gladhand Seals &amp; Accessories, Locks</b>
<b>Gladhands</b>
<b>Swivel Gladhands &amp; Accessories</b>
<b>Gladhands: Swivel, Bracket, Shutoff</b>
<b>Drain Valves, Safety Valves</b>
<b>Quick Release Valves</b>
<b>Spring Brake Valves</b>
<b>SONOGRIP® Cables</b>
<b>7-Way Cables / Zinc Plugs</b>
<b>Bulk Cable, 30-Pin 7-Way Receptacles</b>
<b>7-Way Receptacles</b>
<b>7-Way Receptacles &amp; Adapter Boxes</b>
<b>Smart Box® 7-Way Receptacles</b>
<b>Small Nylon 7-Way Receptacles</b>
<b>Over Molded 7-Way Receptacles</b>
<b>Zinc 7-Way Receptacles &amp; Boxes</b>
<b>7-Way Lid Kits &amp; Parts, Nylon 4-Way</b>
<b>Breakers, Zinc 7-Way Plugs and Sockets</b>
<b>Single Pole, 4&amp;6-Way Plugs &amp; Sockets</b>
<b>Switches</b>

Rubber Hose and Nylon Tubing Assemblies are an important part of the air brake system. They deliver air to your air brake chambers as well as other important systems such as lift gates and lift axles. They can be used along the frame rail as well as the primary hook-up between the tractor and trailer. Tramec Sloan offers and makes in our Holland, MI facility several different styles of air brake hose and nylon tubing assemblies in different configurations to suit each individual's needs. That translates into **AMERICAN QUALITY MADE TO LAST.**

Featured in this section of the catalog you will find several different varieties of rubber hose and nylon tubing assemblies. In addition, the accompanying accessories that repair and organize them.

- MAXXDuty™ Hose Assemblies
- Standard Hose Assemblies
- Slider Hose Assemblies
- Transmission Air Shift Hose Assemblies
- Permanent Swivel Hose Assemblies
- 45° Flare Female Dual Swivel Hose Assemblies
- Air Compressor Discharge Hose Assemblies
- Economical 5-Series Hose Assemblies
- MAXXDUTY™ Coiled Air Assemblies
- Standard Coiled Air Assemblies
- Sliding Fifth Wheel Coiled Air Assemblies
- Coiled Air Assemblies with Brass Handles
- Coiled Air Assemblies with Dura-Grips
- 3-in-1 & 4-in-1 Wrapped Tractor to Trailer Assemblies
- Tractor to Trailer Air Hose Assemblies
- Bulk Nylon Tubing
- Bulk Rubber Hose
- Bulk Air Compressor Discharge Hose
- Air Compressor Discharge Hose Reusable Fittings
- 3/8" and 1/2" Quick-Fix® Repair Kits
- MAXXDuty™ POGO
- The "FAT CAN" POGO
- Tracker Bar Kits
- Tender Springs
- Air Hose Clamps
- Frame Clips
- Air Hose Separators
- Nylon Tube Cutter
- Rubber Tarp Straps
- MAXXClamp™
- The "Puck" Hose Separator
- Hose Clamps
- Nylon and Rubber Clamps

# Rubber Hose Assemblies



*MAXXDuty™ products are designed to help keep trucks moving, no matter what the conditions. The MAXXDuty line of severe-duty products includes patented, premium quality electrical wire harnesses, gladhands, coiled air lines, and our patent pending coiled electrical 7-way sealed plug and socket system.*

*This is our MAXXDuty hose assembly. Learn more about its qualities on the next page.*



## SLOAN DELIVERS

- Patented severe-duty engineering
- Extreme corrosion prevention
- Stands up to harsh weather conditions



### Tramec

#### Rubber Hose Assemblies

#### Coiled Air Assemblies

#### 3-in-1 & 4-in-1 Wraps

#### Bulk Hose

#### Air Compressor Discharge Hose Assemblies

#### Quick Fix™

#### Air Hose Accessories

#### Hose Clamps

#### Gladhands & Accessories

#### Air Tanks

#### Drain Valves

#### Ground Plugs

#### Truck Valves

#### Selector Valves

#### Brass Fittings

#### Hose & Tube Chart

#### Dash Control Valves

#### Air Brake Valves

#### Air Accessory Valves

#### Air Cylinders

#### Switches & Toggles

#### Plugs, Sockets & Cables

#### RV Plugs & Sockets

#### Wire & Cable

#### Electrical Harnesses

#### Electrical Connectors

#### Fuel Caps

#### Oil Caps & Dipsticks

#### Grease Fittings

#### Water Pumps

#### Wiper Blades

#### Engine Heaters

#### Link Cat's Eye®

#### Hub Caps, Axilok® & Securex®

#### Flitz

#### MAXXGreen

Available in  
Blue & Red  
Hose

## MAXXDuty™ Hose Assemblies



- New Plating specifically engineered to fight corrosion.
- Originally developed for naval applications where parts are continuously exposed to salt spray.
- Retains swiveling ability even after long-term exposure to corrosive chemicals.
- Retains rust free finish longer than industry standard hose assemblies.



Air Products

Length	3/8" Hose I.D.			1/2" Hose I.D.		
	1/4"-18 NPTF 1 fixed,1 swivel	3/8"-18 NPTF 1 fixed,1 swivel	3/8"-18 NPTF 2 swivel	3/8"-18 NPTF 1 fixed,1 swivel	3/8"-18 NPTF 2 swivel	1/2"-14 NPTF fixed 3/8"-18 NPTF swivel
8"	453108MAX	453208MAX	453308MAX	452108MAX	452208MAX	452308MAX
12"	453112MAX	453212MAX	453312MAX	452112MAX	452212MAX	452312MAX
14"	453114MAX	453214MAX	453314MAX	452114MAX	452214MAX	452314MAX
16"	453116MAX	453216MAX	453316MAX	452116MAX	452216MAX	452316MAX
18"	453118MAX	453218MAX	453318MAX	452118MAX	452218MAX	452318MAX
20"	453120MAX	453220MAX	453320MAX	452120MAX	452220MAX	452320MAX
22"	453122MAX	453222MAX	453322MAX	452122MAX	452222MAX	452322MAX
24"	453124MAX	453224MAX	453324MAX	452124MAX	452224MAX	452324MAX
26"	453126MAX	453226MAX	453326MAX	452126MAX	452226MAX	452326MAX
28"	453128MAX	453228MAX	453328MAX	452128MAX	452228MAX	452328MAX
30"	453130MAX	453230MAX	453330MAX	452130MAX	452230MAX	452330MAX
32"	453132MAX	453232MAX	453332MAX	452132MAX	452232MAX	452332MAX
34"	453134MAX	453234MAX	453334MAX	452134MAX	452234MAX	452334MAX
36"	453136MAX	453236MAX	453336MAX	452136MAX	452236MAX	452336MAX
38"	453138MAX	453238MAX	453338MAX	452138MAX	452238MAX	452338MAX
40"	453140MAX	453240MAX	453340MAX	452140MAX	452240MAX	452340MAX
42"	453142MAX	453242MAX	453342MAX	452142MAX	452242MAX	452342MAX
44"	453144MAX	453244MAX	453344MAX	452144MAX	452244MAX	452344MAX
46"	453146MAX	453246MAX	453346MAX	452146MAX	452246MAX	452346MAX
48"	453148MAX	453248MAX	453348MAX	452148MAX	452248MAX	452348MAX
50"	453150MAX	453250MAX	453350MAX	452150MAX	452250MAX	452350MAX
52"	453152MAX	453252MAX	453352MAX	452152MAX	452252MAX	452352MAX
54"	453154MAX	453254MAX	---	452154MAX	---	---
56"	453156MAX	453256MAX	453356MAX	452156MAX	452256MAX	452356MAX
60"	453160MAX	453260MAX	453360MAX	452160MAX	452260MAX	452360MAX
66"	453166MAX	453266MAX	453366MAX	452166MAX	452266MAX	452366MAX
72"	453172MAX	453272MAX	453372MAX	452172MAX	452272MAX	452372MAX
84"	453184MAX	453284MAX	453384MAX	452184MAX	452284MAX	452384MAX

# Rubber Hose Assemblies



## Rubber Air Brake Hose

- Minimum burst pressure of 900 psi.
- Conforms to SAE J1402 and DOT-106 specifications.
- Maximum operating pressure of 225 psi.
- Operating temperature of -40°F to +212°F.
- Resistant to gasoline, diesel fuel, oil and commonly used road and cleaning chemicals.
- Air brake hose assembly wall rack available - Sloan number 452000.



## Air Brake Hose Assemblies

LENGTH	3/8" Hose I. D.			1/2" Hose I.D.		
	1/4"-18 1 fixed, 1 swivel	3/8"-18 1 fixed, 1 swivel	3/8"-18 2 swivel	3/8"-18 1 fixed, 1 swivel	3/8"-18 2 swivel	1/2"-14 fixed 3/8"-18 swivel
8"	453108	453208	453308	452108	452208	452308
12"	453112	453212	453312	452112	452212	452312
14"	453114	453214	453314	452114	452214	452314
16"	453116	453216	453316	452116	452216	452316
18"	453118	453218	453318	452118	452218	452318
20"	453120	453220	453320	452120	452220	452320
22"	453122	453222	453322	452122	452222	452322
24"	453124	453224	453324	452124	452224	452324
26"	453126	453226	453326	452126	452226	452326
28"	453128	453228	453328	452128	452228	452328
30"	453130	453230	453330	452130	452230	452330
32"	453132	453232	453332	452132	452232	452332
34"	453134	453234	453334	452134	452234	452334
36"	453136	453236	453336	452136	452236	452336
38"	453138	453238	453338	452138	452238	452338
40"	453140	453240	453340	452140	452240	452340
42"	453142	453242	453342	452142	452242	452342
44"	453144	453244	453344	452144	452244	452344
46"	453146	453246	453346	452146	452246	452346
48"	453148	453248	453348	452148	452248	452348
50"	453150	453250	453350	452150	452250	452350
52"	453152	453252	453352	452152	452252	452352
54"	453154	453254	---	452154	---	---
56"	453156	453256	453356	452156	452256	452356
60"	453160	453260	453360	452160	452260	452360
66"	453166	453266	453366	452166	452266	452366
72"	453172	453272	453372	452172	452272	452372
84"	453184	453284	453384	452184	452284	452384

\* Additional lengths available upon request

**NEED BULK HOSE? See pages 62 & 63**

- Tramec**
- Rubber Hose Assemblies**
- Coiled Air Assemblies**
- 3-in-1 & 4-in-1 Wraps**
- Bulk Hose**
- Air Compressor Discharge Hose Assemblies**
- Quick Fix™**
- Air Hose Accessories**
- Hose Clamps**
- Gladhands & Accessories**
- Air Tanks**
- Drain Valves**
- Ground Plugs**
- Truck Valves**
- Selector Valves**
- Brass Fittings**
- Hose & Tube Chart**
- Dash Control Valves**
- Air Brake Valves**
- Air Accessory Valves**
- Air Cylinders**
- Switches & Toggles**
- Plugs, Sockets & Cables**
- RV Plugs & Sockets**
- Wire & Cable**
- Electrical Harnesses**
- Electrical Connectors**
- Fuel Caps**
- Oil Caps & Dipsticks**
- Grease Fittings**
- Water Pumps**
- Wiper Blades**
- Engine Heaters**
- Link Cat's Eye®**
- Hub Caps, Axilok® & Securex®**
- Flitz**
- MAXXGreen**



Available in  
Blue & Red  
Hose

## Bulkhead Air Brake Hose Assemblies For 3/8" Hose

- For connections from rubber to nylon hose
- Allows for easy installation to the bulkhead

LENGTH	3/8" I.D. Hose Connects to	3/8" I.D. Hose Connects to	3/8" I.D. Hose Connects to
	3/8" O.D. Nylon	1/2" O.D. Nylon	1/2" & 3/8" O.D. Nylon
60"	457060	458060	459060
66"	457066	458066	459066
72"	457072	458072	459072
78"	457078	458078	459078
84"	457084	458084	459084
90"	457090	458090	459090
96"	457096	458096	459096
102"	457102	458102	459102
108"	457108	458108	459108
114"	457114	458114	459114
120"	457120	458120	459120
126"	457126	458126	459126
132"	457132	458132	459132
135"	457135	---	---
138"	457138	458138	459138
144"	457144	458144	459144



Air Products

## Bulkhead Air Brake Hose Assemblies For 1/4" Hose

## Transmission Air Shift Hose Assemblies

Part Number	Length	Description	With Spring
LL7820-108	108"	Hose Assembly Slider 1/4X1/4 Spring	No
LL7820-114	114"	Hose Assembly Slider 1/4	No
LL7820-54	54"	Hose Assembly Slider 3/8X3/8 Tube	No
LL7820-60	60"	Hose Assembly Slider 1/4X1/4 Tube	No
LL7820-72	72"	Hose Assembly Slider 3/8X3/8 Tube	No
LL7820-84	84"	Hose Assembly Slider 3/8X3/8 Tube	No
LL7820-90	90"	Hose Assembly Slider 1/4	No
LL7820-S106	106"	Hose Assembly Slider 1/4X1/4 Spring	Yes
LL7820-S108	108"	Hose Assembly Slider 1/4X1/4 Spring	Yes
LL7820-S114	114"	Hose Assembly Slider 1/4X1/4 Spring	Yes
LL7820-S132	132"	Hose Assembly Slider 1/4X1/4 Spring	Yes
LL7820-S138	138"	Hose Assembly Slider 3/8X3/8 Spring	Yes
LL7820-S150	150"	Hose Assembly Slider 1/4X1/4 Spring	Yes
LL7820-S168	168"	Hose Assembly Slider 1/4X1/4 Spring	Yes
LL7820-S54	54"	Hose Assembly Slider 1/4X1/4 Spring	Yes
LL7820-S60	60"	Hose Assembly Slider 1/4X1/4 Spring	Yes
LL7820-S72	72"	Hose Assembly Slider 1/4X1/4 Spring	Yes
LL7820-S84	84"	Hose Assembly Slider 1/4X1/4 Spring	Yes
LL7820-S96	96"	Hose Assembly Slider 1/4X1/4 Spring	Yes

1/4" Hose I. D.	
1/8"-27 NPTF	
LENGTH	1 fixed, 1 swivel
12"	461112
15"	461115
16"	461116
17"	461117
18"	461118
20"	461120
24"	461124
26"	461126
27"	461127
28"	461128
29"	461129
30"	461130
32"	461132
34"	461134
36"	461136



# Rubber Hose Assemblies



## Permanent Swivel Hose Assemblies Made Of All Brass

- Retains swivel after installation
- Made of all brass swivel fittings

Available in  
Blue & Red  
Hose



LENGTH	1/2" I.D. Hose 3/8"-18 NPTF	3/8" I.D. Hose 3/8"-18 NPTF	3/8" I.D. Hose 1/4"-18 NPTF
	2 swivel	2 swivel	2 swivel
8"	454008	455008	456008
12"	454012	455012	456012
14"	454014	455014	456014
16"	454016	455016	456016
18"	454018	455018	456018
20"	454020	455020	456020
22"	454022	455022	456022
24"	454024	455024	456024
26"	454026	455026	456026
27"	454027	---	---
28"	454028	455028	456028
30"	454030	455030	456030
32"	454032	455032	456032
34"	454034	455034	456034
36"	454036	455036	456036
38"	454038	455038	456038
40"	454040	455040	456040
42"	454042	455042	456042
44"	454044	455044	456044
46"	454046	455046	456046
48"	454048	455048	456048
50"	454050	455050	456050
52"	454052	455052	456052
56"	454056	455056	456056
60"	454060	455060	456060
66"	454066	455066	456066
72"	454072	455072	456072
84"	454084	455084	456084

## Air Brake Hose Assemblies

tractor to trailer hose w/spring guards  
(to be connected to gladhands)



3/8" I.D. Hose 1/2"-14 NPTF	
LENGTH	2 fixed
48"	460048
52"	460052
72"	460072
84"	460084
96"	460096
108"	460108
120"	460120
144"	460144

\* Additional lengths available upon request

### Tramec

#### Rubber Hose Assemblies

#### Coiled Air Assemblies

#### 3-in-1 & 4-in-1 Wraps

#### Bulk Hose

#### Air Compressor Discharge Hose Assemblies

#### Quick Fix™

#### Air Hose Accessories

#### Hose Clamps

#### Gladhands & Accessories

#### Air Tanks

#### Drain Valves

#### Ground Plugs

#### Truck Valves

#### Selector Valves

#### Brass Fittings

#### Hose & Tube Chart

#### Dash Control Valves

#### Air Brake Valves

#### Air Accessory Valves

#### Air Cylinders

#### Switches & Toggles

#### Plugs, Sockets & Cables

#### RV Plugs & Sockets

#### Wire & Cable

#### Electrical Harnesses

#### Electrical Connectors

#### Fuel Caps

#### Oil Caps & Dipsticks

#### Grease Fittings

#### Water Pumps

#### Wiper Blades

#### Engine Heaters

#### Link Cat's Eye®

#### Hub Caps, Axilok® & Securex®

#### Flitz

#### MAXXGreen

Available in  
Blue & Red  
Hose

## Air Brake Hoses with 45° Flare Female Swivel Ends



**Hose:**

3/8" or 1/2" inside diameter rubber, SAE J1402, DOT FMVSS 106.

**End Fittings:**

3/8" & 1/2" Female Swivel 45° Flare Ends.

**Applications:**

Increasingly common in newer model trucks and heavy duty equipment.

**Options:**

Various adapter ends, standard 45° flare connectors. Available in black, red, and blue hose.

### 45° Female Swivel Ends for 3/8" Hose

Part Number	Description	Length	Std. Pack
666600-18	3/8" Air Brake Hose Assy. w/ 3/8" Female Swivel Flare both ends	18"	1
666600-24	3/8" Air Brake Hose Assy. w/ 3/8" Female Swivel Flare both ends	24"	1
666600-30	3/8" Air Brake Hose Assy. w/ 3/8" Female Swivel Flare both ends	30"	1
666600-36	3/8" Air Brake Hose Assy. w/ 3/8" Female Swivel Flare both ends	36"	1
666600-42	3/8" Air Brake Hose Assy. w/ 3/8" Female Swivel Flare both ends	42"	1
666600-48	3/8" Air Brake Hose Assy. w/ 3/8" Female Swivel Flare both ends	48"	1
666600-54	3/8" Air Brake Hose Assy. w/ 3/8" Female Swivel Flare both ends	54"	1
666600-60	3/8" Air Brake Hose Assy. w/ 3/8" Female Swivel Flare both ends	60"	1

### 45° Female Swivel Ends for 1/2" Hose

Part Number	Description	Length	Std. Pack
688800-18	1/2" Air Brake Hose Assy. w/ 1/2" Female Swivel Flare both ends	18"	1
688800-22	1/2" Air Brake Hose Assy. w/ 1/2" Female Swivel Flare both ends	22"	1
688800-24	1/2" Air Brake Hose Assy. w/ 1/2" Female Swivel Flare both ends	24"	1
688800-30	1/2" Air Brake Hose Assy. w/ 1/2" Female Swivel Flare both ends	30"	1
688800-36	1/2" Air Brake Hose Assy. w/ 1/2" Female Swivel Flare both ends	36"	1
688800-42	1/2" Air Brake Hose Assy. w/ 1/2" Female Swivel Flare both ends	42"	1
688800-48	1/2" Air Brake Hose Assy. w/ 1/2" Female Swivel Flare both ends	48"	1
688800-55	1/2" Air Brake Hose Assy. w/ 1/2" Female Swivel Flare both ends	55"	1
688800-60	1/2" Air Brake Hose Assy. w/ 1/2" Female Swivel Flare both ends	60"	1

# Rubber Hose Assemblies



## 5-Series Air Brake Hose Assemblies

Available in  
Blue & Red  
Hose

3/8" Hose, 3/8" Ends,  
Fixed/Swivel



3/8" Hose, 3/8" Ends,  
Double Swivel



Part Number	Length
562366-08	08"
562366-12	12"
562366-14	14"
562366-16	16"
562366-18	18"
562366-20	20"
562366-22	22"
562366-24	24"
562366-26	26"
562366-28	28"
562366-30	30"
562366-32	32"
562366-34	34"
562366-36	36"
562366-38	38"
562366-40	40"
562366-42	42"
562366-44	44"
562366-46	46"
562366-48	48"
562366-50	50"
562366-52	52"
562366-54	54"
562366-56	56"
562366-60	60"
562366-66	66"
562366-72	72"
562366-84	84"

Part Number	Length
563366-08	08
563366-12	12
563366-14	14
563366-16	16
563366-18	18
563366-20	20
563366-22	22
563366-24	24
563366-26	26
563366-28	28
563366-30	30
563366-32	32
563366-34	34
563366-36	36
563366-38	38
563366-40	40
563366-42	42
563366-44	44
563366-46	46
563366-48	48
563366-50	50
563366-52	52
563366-54	54
563366-56	56
563366-60	60
563366-66	66
563366-72	72
563366-84	84

- "5-Series" hose assemblies use an innovative, lightweight internal O-ring and barb to form each swivel.
- Available with standard fixed/swivel ends, or with both ends swivel for added convenience.
- Add pre-applied thread sealant to male threads by adding suffix "V" to any hose assembly part number.
- Plastic sleeving is also available on many of our standard hoses, and available in black, red, and blue rubber hose.
- Springs not available on 5 Series Swivel Ends.



- Tramec
- Rubber Hose Assemblies
- Coiled Air Assemblies
- 3-in-1 & 4-in-1 Wraps
- Bulk Hose
- Air Compressor Discharge Hose Assemblies
- Quick Fix™
- Air Hose Accessories
- Hose Clamps
- Gladhands & Accessories
- Air Tanks
- Drain Valves
- Ground Plugs
- Truck Valves
- Selector Valves
- Brass Fittings
- Hose & Tube Chart
- Dash Control Valves
- Air Brake Valves
- Air Accessory Valves
- Air Cylinders
- Switches & Toggles
- Plugs, Sockets & Cables
- RV Plugs & Sockets
- Wire & Cable
- Electrical Harnesses
- Electrical Connectors
- Fuel Caps
- Oil Caps & Dipsticks
- Grease Fittings
- Water Pumps
- Wiper Blades
- Engine Heaters
- Link Cat's Eye®
- Hub Caps, Axilok® & Securex®
- Flitz
- MAXXGreen

## Air Brake Hose Assembly Wall Display Rack

- Holds up to 48 air hose assemblies.
- 6 hooks for 3/8" air hose assemblies.
- 6 hooks for 1/2" air hose assemblies.
- Each hook holds 4 air hose assemblies.



Sloan No	No. of Hooks
452000	12

## Air Brake Hose Assembly Wall Display Rack

### Sloan No. 452001

Assortment includes one 452000 display rack, label set number 27-547 and 4 each of the following air hose assemblies:



3/8" Hose I.D. 1/4"-18 NPTF 1 fixed,1 swivel	1/2" Hose I.D. 3/8"-18 NPTF 1 fixed,1 swivel
453120	452118
453124	452120
453126	452122
453128	452124
453130	452126
453136	452128

### Sloan No. 452002

Assortment includes one 452000 display rack, label set number 27-548 and 4 each of the following air hose assemblies:

3/8" Hose I.D. 3/8"-18 NPTF 2 swivel	1/2" Hose I.D. 3/8"-18 NPTF 1 fixed,1 swivel
453320	452130
453324	452132
453326	452134
453328	452136
453330	452142
453336	452148

# Coiled Air Assemblies



Tramec Sloan Coiled Air Assemblies are manufactured in the USA at our facility in Holland, Michigan, using the highest quality components available. We certify our assemblies to meet FMVSS 571.106 and 593.45 specifications and the individual components all meet the SAE J844, SAE J476 and SAE J246 specifications. Don't take chances – buy certified Tramec Sloan Coiled Air and buy American made peace of mind.



Tubing spools are used to create individual coiled assemblies.



The spooled tubing is wrapped on the mandrel to correct working lengths.



The mandrels that contain the coiled tubing are placed in the ovens to bake so they retain their coil.



The final stage of creating a coiled tubing set is to attach the brass ends.

Sloan is an industry leader in the manufacture and distribution of coiled air. Now offering over 50 different SKU's.

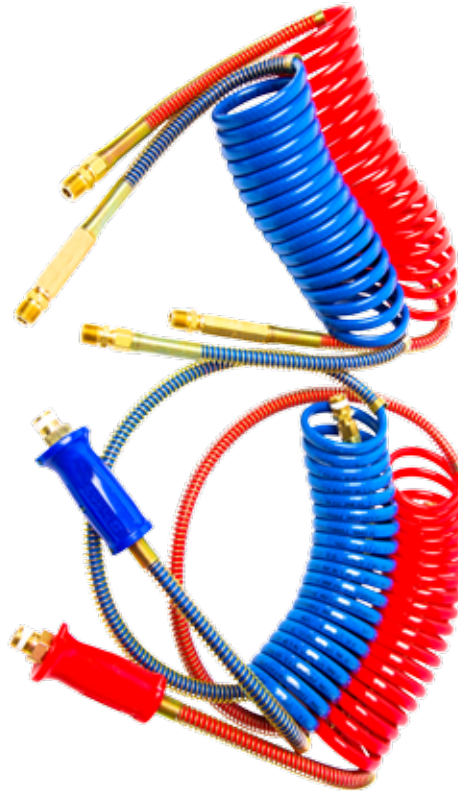

ASSEMBLED IN  
THE U.S.A

## Tramec

### Rubber Hose Assemblies

### Coiled Air Assemblies

### 3-in-1 & 4-in-1 Wraps

### Bulk Hose

### Air Compressor Discharge Hose Assemblies

### Quick Fix™

### Air Hose Accessories

### Hose Clamps

### Gladhands & Accessories

### Air Tanks

### Drain Valves

### Ground Plugs

### Truck Valves

### Selector Valves

### Brass Fittings

### Hose & Tube Chart

### Dash Control Valves

### Air Brake Valves

### Air Accessory Valves

### Air Cylinders

### Switches & Toggles

### Plugs, Sockets & Cables

### RV Plugs & Sockets

### Wire & Cable

### Electrical Harnesses

### Electrical Connectors

### Fuel Caps

### Oil Caps & Dipsticks

### Grease Fittings

### Water Pumps

### Wiper Blades

### Engine Heaters

### Link Cat's Eye®

### Hub Caps, Axilok® & Securex®

### Flitz

### MAXXGreen

## MAXXDuty Coiled Air Brake Tubing Assemblies



- Working pressure: 150 psi.
- Exceeds SAE J844.
- Operating temperature of -70°F to +220°F.



Sloan No.	Working Length	Standard Package	Lead Length	Fitting Size
451035•	12 ft.	1-Red/1-Blue	2-6"	1/2
451035B	12 ft.	1-Blue	2-6"	1/2
451035R	12 ft.	1-Red	2-6"	1/2
451036•	15 ft.	1-Red/1-Blue	2-10"	1/2
451036B	15 ft.	1-Blue	2-10"	1/2
451036R	15 ft.	1-Red	2-10"	1/2
451039•	15 ft.	1-Red/1-Blue	1-40"/1-10"	1/2
451039B	15 ft.	1-Blue	1-40"/1-10"	1/2
451039R	15 ft.	1-Red	1-40"/1-10"	1/2

• Indicates item is available as 96 pieces on a skid.

## Coiled Nylon Air Brake Tubing Assemblies

- Working pressure: 150 psi.
- Conforms to SAE J844.
- Operating temperature of -65°F to +200°F.



Sloan No.	Working Length	Standard Package	Lead Length	O.D.	Fitting Size
451035N•	12 ft.	1-Red/1-Blue	2-6"	1/2"	1/2"
451035NB	12 ft.	1-Blue	2-6"	1/2"	1/2"
451035NR	12 ft.	1-Red	2-6"	1/2"	1/2"
451036N•	15 ft.	1-Red/1-Blue	2-12"	1/2"	1/2"
451036NB	15 ft.	1-Blue	2-12"	1/2"	1/2"
451036NR	15 ft.	1-Red	2-12"	1/2"	1/2"
451039N•	15 ft.	1-Red/1-Blue	1-40"/1-12"	1/2"	1/2"
451039NB	15 ft.	1-Blue	1-40"/1-12"	1/2"	1/2"
451039NR	15 ft.	1-Red	1-40"/1-12"	1/2"	1/2"
451056N	15 ft.	1-Red/1-Blue	2-12"	1/2"	3/8"
451056NB	15 ft.	1-Blue	2-12"	1/2"	3/8"
451056NR	15 ft.	1-Red	2-12"	1/2"	3/8"
451061N	20 ft.	1-Red/1-Blue	2-12"	1/2"	3/8"
451061NB	20 ft.	1-Blue	2-12"	1/2"	3/8"
451061NR	20 ft.	1-Red	2-12"	1/2"	3/8"
451064N	8 ft.	1-Red/1-Blue	2-6"	1/2"	1/2"
451064NB	8 ft.	1-Blue	2-6"	1/2"	1/2"
451064NR	8 ft.	1-Red	2-6"	1/2"	1/2"
451093N	15 ft.	1-Red/1-Blue	1-48"/1-12"	1/2"	1/2"
451093NB	15 ft.	1-Blue	1-48"/1-12"	1/2"	1/2"
451093NR	15 ft.	1-Red	1-48"/1-12"	1/2"	1/2"
451092N	15 ft.	1-Red/1-Blue	1-72"/1-12"	1/2"	1/2"
451092NB	15 ft.	1-Blue	1-72"/1-12"	1/2"	1/2"
451092NR	15 ft.	1-Red	1-72"/1-12"	1/2"	1/2"

• Item is available as 96 pieces on a skid. Order part number with suffix -96.

## Sliding Fifth Wheel Coiled Nylon Air Line

- Coiled black nylon air hose with spring guard extends up to 5 ft.

Sloan No.	1/4" O.D. Hose 1/4"-14 NPTF
451055	60"



# Coiled Air Assemblies



## Coiled Nylon Air Brake Tubing Assemblies With BRASS HANDLE



Sloan No.	Working Length	Standard Package	Lead Length	O.D.
451040N	12 ft.	1-Red/1-Blue	2-6"	1/2"
451040NB	12 ft.	1-Blue	2-6"	1/2"
451040NR	12 ft.	1-Red	2-6"	1/2"
451041N	15 ft.	1-Red/1-Blue	2-12"	1/2"
451041NB	15 ft.	1-Blue	2-12"	1/2"
451041NR	15 ft.	1-Red	2-12"	1/2"
451042N	15 ft.	1-Red/1-Blue	1-40"/1-12"	1/2"
451042NB	15 ft.	1-Blue	1-40"/1-12"	1/2"
451042NR	15 ft.	1-Red	1-40"/1-12"	1/2"
451091N	15 ft.	1-Red/1-Blue	1-48"/1-12"	1/2"
451091NB	15 ft.	1-Blue	1-48"/1-12"	1/2"
451091NR	15 ft.	1-Red	1-48"/1-12"	1/2"

## Coiled Nylon Air Brake Tubing Assemblies With DURA-GRIP



Sloan No.	Working Length	Standard Package	Lead Length	O.D.
451089N	15 ft.	1-Red/1-Blue	2-12"	1/2"
451089NB	15 ft.	1-Blue	2-12"	1/2"
451089NR	15 ft.	1-Red	2-12"	1/2"
451090N	15 ft.	1-Red/1-Blue	1-40"/1-12"	1/2"
451090NB	15 ft.	1-Blue	1-40"/1-12"	1/2"
451090NR	15 ft.	1-Red	1-40"/1-12"	1/2"

## Coiled Nylon Air Brake Tubing Display Box

- Holds up to 36 sets of coiled air hose assemblies.



Sloan No.	Contents	Qty
451066	Display box (without product)	1
451035NP	12' coiled nylon air brake tubing	36
451036NP	15' coiled nylon air brake tubing	24
451039NP	15' x 40" coiled nylon air brake tubing	18

### Tramec

### Rubber Hose Assemblies

### Coiled Air Assemblies

### 3-in-1 & 4-in-1 Wraps

### Bulk Hose

### Air Compressor Discharge Hose Assemblies

### Quick Fix™

### Air Hose Accessories

### Hose Clamps

### Gladhands & Accessories

### Air Tanks

### Drain Valves

### Ground Plugs

### Truck Valves

### Selector Valves

### Brass Fittings

### Hose & Tube Chart

### Dash Control Valves

### Air Brake Valves

### Air Accessory Valves

### Air Cylinders

### Switches & Toggles

### Plugs, Sockets & Cables

### RV Plugs & Sockets

### Wire & Cable

### Electrical Harnesses

### Electrical Connectors

### Fuel Caps

### Oil Caps & Dipsticks

### Grease Fittings

### Water Pumps

### Wiper Blades

### Engine Heaters

### Link Cat's Eye®

### Hub Caps, Axilok® & Securex®

### Flitz

### MAXXGreen



## 3-in-1 Wraps, Black Hose



\* Now Available With Color Coated Springs For Easy Identification  
 \* New Feature-All Wraps Come With A Hanger Clamp (P/N 451089)

Part No.	Description	Length	Fitting Diameter		Handle Type	Electrical Cable Description
			A=Gladhand	B=Tractor		
451097	3-in-1 Wrap	12'	A= 1/2"	B= 1/2"	441751 Dura-Grip	421166 ElectraPlus 7-Way ABS Green Jacket
451098	3-in-1 Wrap	15'	A= 1/2"	B= 1/2"	441751 Dura-Grip	421167 ElectraPlus 7-Way ABS Green Jacket
451099	3-in-1 Wrap	20'	A= 1/2"	B= 1/2"	441751 Dura-Grip	421247 ElectraPlus 7-Way ABS Green Jacket
451107	3-in-1 Wrap	12'	A= 1/2"	B= 1/2"	441751 Dura-Grip	421164 Economy 7-Way Black Jacket
451108	3-in-1 Wrap	15'	A= 1/2"	B= 1/2"	441751 Dura-Grip	421164 Economy 7-Way Black Jacket
451111	3-in-1 Wrap	12'	A= 1/2"	B= 1/2"	441751 Dura-Grip	421166 ElectraPlus 7-Way ABS Green Jacket
451112	3-in-1 Wrap	15'	A= 1/2"	B= 1/2"	441751 Dura-Grip	421167 ElectraPlus 7-Way ABS Green Jacket
451113	3-in-1 Wrap	20'	A= 1/2"	B= 1/2"	441751 Dura-Grip	421247 ElectraPlus 7-Way ABS Green Jacket
451114	3-in-1 Wrap	6'	A= 1/2"	B= 1/2"	None	421280 Economy 7-Way Black Jacket
451119	3-in-1 Wrap	12'	A= 1/2"	B= 1/2"	441799 Aluminum	421166 ElectraPlus 7-Way ABS Green Jacket
451120	3-in-1 Wrap	15'	A= 1/2"	B= 1/2"	441799 Aluminum	421167 ElectraPlus 7-Way ABS Green Jacket
451121	3-in-1 Wrap	20'	A= 1/2"	B= 1/2"	441799 Aluminum	421247 ElectraPlus 7-Way ABS Green Jacket
451183	3-in-1 Wrap	12'	A= 1/2"	B= 1/2"	MAXXGrip	421166 ElectraPlus 7-Way ABS Green Jacket
451184	3-in-1 Wrap	15'	A= 1/2"	B= 1/2"	MAXXGrip	421167 ElectraPlus 7-Way ABS Green Jacket
451185	3-in-1 Wrap	20'	A= 1/2"	B= 1/2"	MAXXGrip	421247 ElectraPlus 7-Way ABS Green Jacket
451186	3-in-1 Wrap	12'	A= 1/2"	B= 1/2"	Powder Coated MAXXGrip	421166 ElectraPlus 7-Way ABS Green Jacket
451187	3-in-1 Wrap	15'	A= 1/2"	B= 1/2"	Powder Coated MAXXGrip	421167 ElectraPlus 7-Way ABS Green Jacket
451188	3-in-1 Wrap	20'	A= 1/2"	B= 1/2"	Powder Coated MAXXGrip	421247 ElectraPlus 7-Way ABS Green Jacket

Air Products

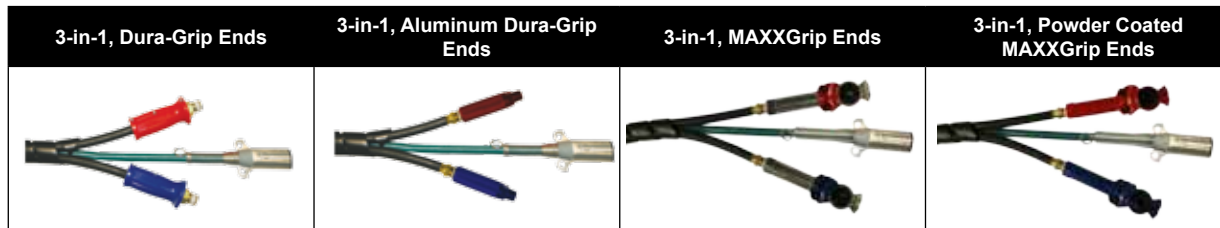

## 3-in-1 Wraps, Red & Blue Hose

Part No.	Description	Length	Fitting Diameter		Handle Type	Electrical Cable Description
			A=Gladhand	B=Tractor		
451180	3-in-1 Wrap	12'	A= 1/2"	B= 1/2"	441751 Dura-Grip	421166 ElectraPlus 7-Way ABS Green Jacket
451181	3-in-1 Wrap	15'	A= 1/2"	B= 1/2"	441751 Dura-Grip	421167 ElectraPlus 7-Way ABS Green Jacket
451182	3-in-1 Wrap	20'	A= 1/2"	B= 1/2"	441751 Dura-Grip	421247 ElectraPlus 7-Way ABS Green Jacket
451189	3-in-1 Wrap	12'	A= 1/2"	B= 1/2"	MAXXGrip	421166 ElectraPlus 7-Way ABS Green Jacket
451190	3-in-1 Wrap	15'	A= 1/2"	B= 1/2"	MAXXGrip	421167 ElectraPlus 7-Way ABS Green Jacket
451191	3-in-1 Wrap	20'	A= 1/2"	B= 1/2"	MAXXGrip	421247 ElectraPlus 7-Way ABS Green Jacket
451192	3-in-1 Wrap	12'	A= 1/2"	B= 1/2"	Powder Coated MAXXGrip	421166 ElectraPlus 7-Way ABS Green Jacket
451193	3-in-1 Wrap	15'	A= 1/2"	B= 1/2"	Powder Coated MAXXGrip	421167 ElectraPlus 7-Way ABS Green Jacket
451194	3-in-1 Wrap	20'	A= 1/2"	B= 1/2"	Powder Coated MAXXGrip	421247 ElectraPlus 7-Way ABS Green Jacket



\* Now Available With Color Coated Springs For Easy Identification  
 \* New Feature-All Wraps Come With A Hanger Clamp (P/N 451089)

# 3-in-1 & 4-in-1 Wraps

## 4-in-1 Wraps, Yellow ISO Cord

- \* Now Available With Color Coated Springs For Easy Identification
- \* New Feature-All Wraps Come With A Hanger Clamp (P/N 451089)



Part No.	Description	Length	Fitting Diameter		Handle Type	Electrical Cable Description
			A=Gladhand	B=Tractor		
451122*	4-in-1 Wrap	12'	A= 1/2" B= 1/2"		441751 Dura-Grip	421166 ElectraPlus 7-Way ABS Green Jacket
451123*	4-in-1 Wrap	15'	A= 1/2" B= 1/2"		441751 Dura-Grip	421167 ElectraPlus 7-Way ABS Green Jacket
451124*	4-in-1 Wrap	12'	A= 1/2" B= 1/2"		441799 Aluminum	421166 ElectraPlus 7-Way ABS Green Jacket
451125*	4-in-1 Wrap	15'	A= 1/2" B= 1/2"		441799 Aluminum	421167 ElectraPlus 7-Way ABS Green Jacket

\* Item Contains Hose I.D. Of 3/8" and Yellow ISO Cord

## 4-in-1 Single & Double Pole Lift-Gate Cables

- \* Now Available With Color Coated Springs For Easy Identification
- \* New Feature-All Wraps Come With A Hanger Clamp (P/N 451089)

Part No.	Description	Length	Fitting Diameter		Handle Type	Electrical Cable Description
			A=Gladhand	B=Tractor		
451129**	4-in-1 Wrap	12'	A= 1/2" B= 1/2"		441751 Dura-Grip	Single Pole Straight Lift Gate Cable/ 7-Way ABS Green Jacket
451130**	4-in-1 Wrap	15'	A= 1/2" B= 1/2"		441751 Dura-Grip	Single Pole Straight Lift Gate Cable/ 7-Way ABS Green Jacket
451131**	4-in-1 Wrap	20'	A= 1/2" B= 1/2"		441751 Dura-Grip	Single Pole Straight Lift Gate Cable/ 7-Way ABS Green Jacket
451139**	4-in-1 Wrap	12'	A= 1/2" B= 1/2"		441751 Dura-Grip	Double Pole Straight Lift Gate Cable/ 7-Way ABS Green Jacket
451140**	4-in-1 Wrap	15'	A= 1/2" B= 1/2"		441751 Dura-Grip	Double Pole Straight Lift Gate Cable/ 7-Way ABS Green Jacket
451141**	4-in-1 Wrap	20'	A= 1/2" B= 1/2"		441751 Dura-Grip	Double Pole Straight Lift Gate Cable/ 7-Way ABS Green Jacket
451149**	4-in-1 Wrap	12'	A= 1/2" B= 1/2"		441799 Aluminum	Single Pole Straight Lift Gate Cable/ 7-Way ABS Green Jacket
451150**	4-in-1 Wrap	15'	A= 1/2" B= 1/2"		441799 Aluminum	Single Pole Straight Lift Gate Cable/ 7-Way ABS Green Jacket
451151**	4-in-1 Wrap	20'	A= 1/2" B= 1/2"		441799 Aluminum	Single Pole Straight Lift Gate Cable/ 7-Way ABS Green Jacket
451159**	4-in-1 Wrap	12'	A= 1/2" B= 1/2"		441799 Aluminum	Double Pole Straight Lift Gate Cable/ 7-Way ABS Green Jacket
451160**	4-in-1 Wrap	15'	A= 1/2" B= 1/2"		441799 Aluminum	Double Pole Straight Lift Gate Cable/ 7-Way ABS Green Jacket
451161**	4-in-1 Wrap	20'	A= 1/2" B= 1/2"		441799 Aluminum	Double Pole Straight Lift Gate Cable/ 7-Way ABS Green Jacket

\*\* Item Comes With Optional Starter Lug



Additional variations available upon request.  
Contact your Tramec Sloan representative for more details.



451098  
3-in-1 Wrap, Dura-Grip Ends  
With ABS Green Jacket

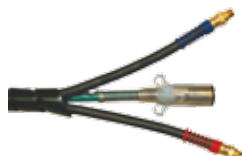

Color Coated Springs For Easy  
Identification



451149  
Single Pole Straight Lift Gate With  
ABS Green Jacket

Tramec  
Rubber Hose  
Assemblies

Coiled Air  
Assemblies

3-in-1 & 4-in-1 Wraps

Bulk Hose

Air Compressor  
Discharge Hose  
Assemblies

Quick Fix™

Air Hose  
Accessories

Hose Clamps

Gladhands &  
Accessories

Air Tanks

Drain Valves

Ground Plugs

Truck Valves

Selector Valves

Brass Fittings

Hose & Tube Chart

Dash Control Valves

Air Brake Valves

Air Accessory  
Valves

Air Cylinders

Switches & Toggles

Plugs, Sockets  
& Cables

RV Plugs & Sockets

Wire & Cable

Electrical Harnesses

Electrical  
Connectors

Fuel Caps

Oil Caps & Dipsticks

Grease Fittings

Water Pumps

Wiper Blades

Engine Heaters

Link Cat's Eye®

Hub Caps, Axilok®  
& Securex®

Flitz

MAXXGreen

## 3-in-1 & 4-in-1 Replacement Parts

Part Number	Description
421296	12' Single Pole Straight Lift Gate Cable
421297	15' Single Pole Straight Lift Gate Cable
421298	20' Single Pole Straight Lift Gate Cable
421300	12' Double Pole Straight Lift Gate Cable
421301	15' Double Pole Straight Lift Gate Cable
421302	20' Double Pole Straight Lift Gate Cable
451089	3-in-1 Power/Air Line Hanger Clamp
451096	Carabiner
451106	Bulk Spiral Wrap 100', 1.14" Dia
451116	Bulk Spiral Wrap 100', 1.5" Dia
451117	Bulk Spiral Wrap 100', 2" Dia
451118	Bulk Spiral Wrap 100', 3" Dia
455168	15'-3/8" Rubber Hose With 1/2" Fittings
455228	20'-3/8" Rubber Hose With 1/2" Fittings
455129AB	Hose Assy, Air, 3/8" X 144" W/ Blue Aluminum Dura-Grip
455129AR	Hose Assy, Air, 3/8" X 144" W/ Red Aluminum Dura-Grip
455132B	Hose Assy, Air, 3/8" X 144" W/ Blue Dura-Grip
455132R	Hose Assy, Air, 3/8" X 144" W/ Red Dura-Grip
455165AB	15'-3/8" Rubber Hose Blue Aluminum Dura-Grip
455165AR	15'-3/8" Rubber Hose Red Aluminum Dura-Grip
455168B	15'-3/8" Rubber Hose Blue Dura-Grip
455168R	15'-3/8" Rubber Hose Red Dura-Grip
455225AB	20'-3/8" Rubber Hose Blue Aluminum Dura-Grip
455225AR	20'-3/8" Rubber Hose Red Aluminum Dura-Grip
455228B	20'-3/8" Rubber Hose Blue Dura-Grip
455228R	20'-3/8" Rubber Hose Red Dura-Grip



455168B  
15'-3/8" Rubber Hose With  
Blue Dura-Grip



451089  
3-in-1 and 4-in-1 Power-Air Line  
Hanger Clamp  
(Includes Carabiner 451096)



3" Dia Bulk Spiral  
Wrap  
100' / Box  
451118



Carabiner  
451096

# Coiled Air Alternatives



## Tractor to Trailer Air Hose Assemblies, Black Hose

Part Number	Description
455144	3/8" X 12' Black Hose With 1/2" Fittings
455144AR	3/8" X 12' Black Hose With Red Aluminum Dura-Grip
455144RMAXX	3/8" X 12' Black Hose With Red MAXXGrip
455144PRMAXX	3/8" X 12' Black Hose With Red Pwdr Coated MAXXGrip
455144R	3/8" X 12' Black Hose With Red Dura Grip
455144AB	3/8" X 12' Black Hose With Blue Aluminum Dura-Grip
455144BMAXX	3/8" X 12' Black Hose With Blue MAXXGrip
455144PBMAXX	3/8" X 12' Black Hose With Blue Pwdr Coated MAXXGrip
455144B	3/8" X 12' Black Hose With Blue Dura Grip
455180	3/8" X 15' Black Hose With 1/2" Fittings
455180AR	3/8" X 15' Black Hose With Red Aluminum Dura-Grip
455180RMAXX	3/8" X 15' Black Hose With Red MAXXGrip
455180PRMAXX	3/8" X 15' Black Hose With Red Pwdr Coated MAXXGrip
455180R	3/8" X 15' Black Hose With Red Dura Grip
455180AB	3/8" X 15' Black Hose With Blue Aluminum Dura-Grip
455180BMAXX	3/8" X 15' Black Hose With Blue MAXXGrip
455180PBMAXX	3/8" X 15' Black Hose With Blue Pwdr Coated MAXXGrip
455180B	3/8" X 15' Black Hose With Blue Dura Grip
455240	3/8" X 20' Black Hose With 1/2" Fittings
455240AR	3/8" X 20' Black Hose With Red Aluminum Dura-Grip
455240RMAXX	3/8" X 20' Black Hose With Red MAXXGrip
455240PRMAXX	3/8" X 20' Black Hose With Red Pwdr Coated MAXXGrip
455240R	3/8" X 20' Black Hose With Red Dura Grip
455240AB	3/8" X 20' Black Hose With Blue Aluminum Dura-Grip
455240BMAXX	3/8" X 20' Black Hose With Blue MAXXGrip
455240PBMAXX	3/8" X 20' Black Hose With Blue Pwdr Coated MAXXGrip
455240B	3/8" X 20' Black Hose With Blue Dura Grip

For hose assembly sets see page 61



- Minimum burst pressure of 900 psi
- Conforms to SAE J1402 and DOT-106 specifications
- Maximum operating pressure of 225 psi
- Operating temperature of -40°F to +212°F
- Resistant to gasoline, diesel fuel, oil and commonly used road and cleaning chemicals
- Available with red and blue springs on end.

- Tramec
- Rubber Hose Assemblies
- Coiled Air Assemblies
- 3-in-1 & 4-in-1 Wraps
- Bulk Hose
- Air Compressor Discharge Hose Assemblies
- Quick Fix™
- Air Hose Accessories
- Hose Clamps
- Gladhands & Accessories
- Air Tanks
- Drain Valves
- Ground Plugs
- Truck Valves
- Selector Valves
- Brass Fittings
- Hose & Tube Chart
- Dash Control Valves
- Air Brake Valves
- Air Accessory Valves
- Air Cylinders
- Switches & Toggles
- Plugs, Sockets & Cables
- RV Plugs & Sockets
- Wire & Cable
- Electrical Harnesses
- Electrical Connectors
- Fuel Caps
- Oil Caps & Dipsticks
- Grease Fittings
- Water Pumps
- Wiper Blades
- Engine Heaters
- Link Cat's Eye®
- Hub Caps, Axilok® & Securex®
- Flitz
- MAXXGreen

## Tractor to Trailer Air Hose Assemblies, Red Hose

For hose assembly sets  
see page 61

- Maximum burst pressure of 870 psi
- Conforms to SAE J1402 and DOT-106 specifications
- Hose has increased flexibility that makes for easier installation
- Straight red air hose assemblies with MAXXGrip/Dura-Grip ends for tractor to trailer connections.
- Available with red springs on end

Part Number	Description
R455144	3/8" X 12' Red Hose With 1/2" Fittings
R455144AR	3/8" X 12' Red Hose With Red Aluminum Dura-Grip
R455144RMAXX	3/8" X 12' Red Hose With Red MAXXGrip
R455144PRMAXX	3/8" X 12' Red Hose With Red Powder Coated MAXXGrip
R455144R	3/8" X 12' Red Hose With Red Dura-Grip
R455180	3/8" X 15' Red Hose With 1/2" Fittings
R455180AR	3/8" X 15' Red Hose With Red Aluminum Dura-Grip
R455180RMAXX	3/8" X 15' Red Hose With Red MAXXGrip
R455180PRMAXX	3/8" X 15' Red Hose With Red Powder Coated MAXXGrip
R455180R	3/8" X 15' Red Hose With Red Dura-Grip
R455240	3/8" X 20' Red Hose With 1/2" Fittings
R455240AR	3/8" X 20' Red Hose With Red Aluminum Dura-Grip
R455240RMAXX	3/8" X 20' Red Hose With Red MAXXGrip
R455240PRMAXX	3/8" X 20' Red Hose With Red Powder Coated MAXXGrip
R455240R	3/8" X 20' Red Hose With Red Dura-Grip



## Tractor to Trailer Air Hose Assemblies, Blue Hose

For hose assembly sets  
see page 61

- Maximum burst pressure of 870 psi
- Conforms to SAE J1402 and DOT-106 specifications
- Hose has increased flexibility that makes for easier installation
- Straight blue air hose assemblies with MAXXGrip/Dura-Grip ends for tractor to trailer connections.
- Available with blue springs on end

Part Number	Description
B455144	3/8" X 12' Blue Hose With 1/2" Fittings
B455144AB	3/8" X 12' Blue Hose With Blue Aluminum Dura-Grip
B455144BMAXX	3/8" X 12' Blue Hose With Blue MAXXGrip
B455144PBMAXX	3/8" X 12' Blue Hose With Blue Powder Coated MAXXGrip
B455144B	3/8" X 12' Blue Hose With Blue Dura-Grip
B455180	3/8" X 15' Blue Hose With 1/2" Fittings
B455180AB	3/8" X 15' Blue Hose With Blue Aluminum Dura-Grip
B455180BMAXX	3/8" X 15' Blue Hose With Blue MAXXGrip
B455180PBMAXX	3/8" X 15' Blue Hose With Blue Powder Coated MAXXGrip
B455180B	3/8" X 15' Blue Hose With Blue Dura-Grip
B455240	3/8" X 20' Blue Hose With 1/2" Fittings
B455240AB	3/8" X 20' Blue Hose With Blue Aluminum Dura-Grip
B455240BMAXX	3/8" X 20' Blue Hose With Blue MAXXGrip
B455240PBMAXX	3/8" X 20' Blue Hose With Blue Powder Coated MAXXGrip
B455240B	3/8" X 20' Blue Hose With Blue Dura-Grip

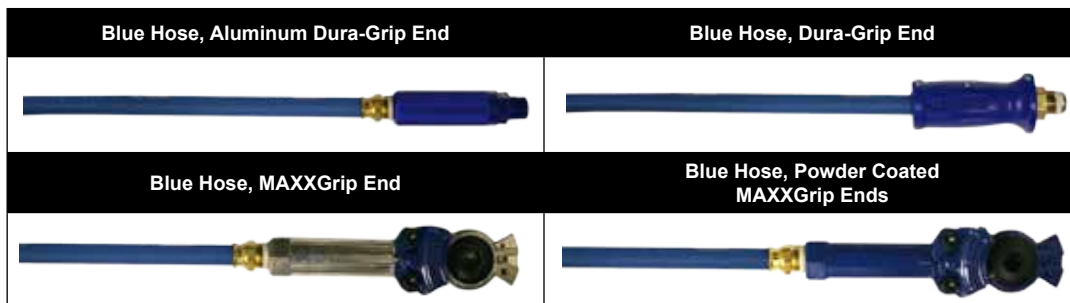

# Coiled Air Alternatives



## Tractor to Trailer Air Hose Assemblies, Black Hose Sets

Part Number	Description
455144SET	3/8" x 12' Black Hose with 1/2" Fittings Set
455144ASET	3/8" x 12' Black Hose with Aluminum Dura-Grip Set
455144DSET	3/8" x 12' Black Hose with Dura-Grip Set
455144MAXXSET	3/8" x 12' Black Hose with MAXXGrip Set
455144PMAXXSET	3/8" x 12' Black Hose with Powder Coated MAXXGrip Set
455180SET	3/8" x 15' Black Hose with 1/2" Fittings Set
455180ASET	3/8" x 15' Black Hose with Aluminum Dura-Grip Set
455180DSET	3/8" x 15' Black Hose with Dura-Grip Set
455180MAXXSET	3/8" x 15' Black Hose with MAXXGrip Set
455180PMAXXSET	3/8" x 15' Black Hose with Powder Coated MAXXGrip Set
455240SET	3/8" x 20' Black Hose with 1/2" Fittings Set
455240ASET	3/8" x 20' Black Hose with Aluminum Dura-Grip Set
455240DSET	3/8" x 20' Black Hose with Dura-Grip Set
455240MAXXSET	3/8" x 20' Black Hose with MAXXGrip Set
455240PMAXXSET	3/8" x 20' Black Hose with Powder Coated MAXXGrip Set

## Tractor to Trailer Air Hose Assemblies, Blue & Red Hose Sets

Part Number	Description
BR455144SET	3/8" x 12' Blue and Red Hose with 1/2" Fittings Set
BR455144ASET	3/8" x 12' Blue and Red Hose with Aluminum Dura-Grip Set
BR455144DSET	3/8" x 12' Blue and Red Hose with Dura-Grip Set
BR455144MAXXSET	3/8" x 12' Blue and Red Hose with MAXXGrip Set
BR455144PMAXXSET	3/8" x 12' Blue and Red Hose with Powder Coated MAXXGrip Set
BR455180SET	3/8" x 15' Blue and Red Hose with 1/2" Fittings Set
BR455180ASET	3/8" x 15' Blue and Red Hose with Aluminum Dura-Grip Set
BR455180DSET	3/8" x 15' Blue and Red Hose with Dura-Grip Set
BR455180MAXXSET	3/8" x 15' Blue and Red Hose with MAXXGrip Set
BR455180PMAXXSET	3/8" x 15' Blue and Red Hose with Powder Coated MAXXGrip Set
BR455240SET	3/8" x 20' Blue and Red Hose with 1/2" Fittings Set
BR455240ASET	3/8" x 20' Blue and Red Hose with Aluminum Dura-Grip Set
BR455240DSET	3/8" x 20' Blue and Red Hose with Dura-Grip Set
BR455240MAXXSET	3/8" x 20' Blue and Red Hose with MAXXGrip Set
BR455240PMAXXSET	3/8" x 20' Blue and Red Hose with Powder Coated MAXXGrip Set

Tractor to trailer air hose assembly kits include one service and one emergency hose

- Maximum burst pressure of 870 psi
- Conforms to SAE J1402 and DOT-106 specifications
- Hose has increased flexibility that makes for easier installation
- Straight red & blue air hose assemblies with MAXXGrip/Dura-Grip ends for tractor to trailer connections
- Available with red and blue springs on end



P/N BR455144PMAXXSET

Tramec
Rubber Hose Assemblies
Coiled Air Assemblies
3-in-1 & 4-in-1 Wraps
Bulk Hose
Air Compressor Discharge Hose Assemblies
Quick Fix™
Air Hose Accessories
Hose Clamps
Gladhands & Accessories
Air Tanks
Drain Valves
Ground Plugs
Truck Valves
Selector Valves
Brass Fittings
Hose & Tube Chart
Dash Control Valves
Air Brake Valves
Air Accessory Valves
Air Cylinders
Switches & Toggles
Plugs, Sockets & Cables
RV Plugs & Sockets
Wire & Cable
Electrical Harnesses
Electrical Connectors
Fuel Caps
Oil Caps & Dipsticks
Grease Fittings
Water Pumps
Wiper Blades
Engine Heaters
Link Cat's Eye®
Hub Caps, Axilok® & Securex®
Flitz
MAXXGreen

## Nylon Air Brake Tubing - BULK

- Available in a variety of colors and sizes.
- Conforms to SAE J844.
- Operating temperature of -65°F to +200°F.
- Excellent durability and weather resistance.

Max Pressure  
150 PSI



Sloan No.	Length	O.D.	Color
451029	100 ft.	1/8	Black
451029-2000	2,000 ft.	1/8	Black
451067	100 ft.	5/32	Black
451067-1000	1000 ft.	5/32	Black
451068	100 ft.	3/16	Black
451068-1000	1000 ft.	3/16	Black
451030	100 ft.	1/4	Black
451030B	100 ft.	1/4	Blue
451030G	100 ft.	1/4	Green
451030NG	100 ft.	1/4	Orange
451030R	100 ft.	1/4	Red
451030Y	100 ft.	1/4	Yellow
451030-1000	1,000 ft.	1/4	Black
451030B-1000	1,000 ft.	1/4	Blue
451030G-1000	1,000 ft.	1/4	Green
451030NG-1000	1,000 ft.	1/4	Orange
451030R-1000	1,000 ft.	1/4	Red
451030Y-1000	1,000 ft.	1/4	Yellow
451054	100 ft.	5/16	Black
451054-500	500 ft.	5/16	Black
451031	100 ft.	3/8	Black
451031B	100 ft.	3/8	Blue
451031G	100 ft.	3/8	Green
451031NG	100 ft.	3/8	Orange
451031R	100 ft.	3/8	Red
451031Y	100 ft.	3/8	Yellow
451031-500	500 ft.	3/8	Black
451031B-500	500 ft.	3/8	Blue
451031G-500	500 ft.	3/8	Green
451031NG-500	500 ft.	3/8	Orange
451031R-500	500 ft.	3/8	Red
451031Y-500	500 ft.	3/8	Yellow

Sloan No.	Length	O.D.	Color
451032	100 ft.	1/2	Black
451032B	100 ft.	1/2	Blue
451032G	100 ft.	1/2	Green
451032NG	100 ft.	1/2	Orange
451032R	100 ft.	1/2	Red
451032Y	100 ft.	1/2	Yellow
451032-500	500 ft.	1/2	Black
451032B-500	500 ft.	1/2	Blue
451032G-500	500 ft.	1/2	Green
451032NG-500	500 ft.	1/2	Orange
451032R-500	500 ft.	1/2	Red
451032Y-500	500 ft.	1/2	Yellow
451033	50 ft.	5/8	Black
451033B	50 ft.	5/8	Blue
451033G	50 ft.	5/8	Green
451033NG	50 ft.	5/8	Orange
451033R	50 ft.	5/8	Red
451033Y	50 ft.	5/8	Yellow
451033-250	250 ft.	5/8	Black
451033B-250	250 ft.	5/8	Blue
451033G-250	250 ft.	5/8	Green
451033NG-250	250 ft.	5/8	Orange
451033R-250	250 ft.	5/8	Red
451033Y-250	250 ft.	5/8	Yellow
451034	50 ft.	3/4	Black
451034-250	250 ft.	3/4	Black



# Bulk Hose

- Minimum burst pressure of 900 psi
- Conforms to SAE J1402 and DOT-106 specifications
- Maximum operating pressure of 225 psi
- Operating temperature of -40°F to +212°F
- Resistant to gasoline, diesel fuel, oil and commonly used road and cleaning chemicals



## Air Brake Hose - BULK

Sloan No	Length	I.D.	O.D.
451027	50 ft.	3/8	3/4
451062	100 ft.	3/8	3/4
451028	250 ft.	3/8	3/4
451045	50 ft.	1/2	7/8
451063	100 ft.	1/2	7/8
451044	250 ft.	1/2	7/8

\* Additional lengths available upon request



## Air Compressor Discharge Hose - BULK

Sloan No.	Length	I.D.	O.D.
462000	25'	1/2"	5/8"
462001	100'	1/2"	5/8"
462002	25'	5/8"	3/4"

## Air Compressor Discharge Hose Reusable Fittings

Part Number	Description	Figure	Std. Pack	O.D. Hose Size	Pipe Thread
S51-10B	Size 10 Brass Ferule	A	5	5/8"	N/A
S51-12B	Size 12 Brass Ferule	A	5	3/4"	N/A
S52-10	Size 10 Socket	B/C	5	5/8"	N/A
S52-12	Size 12 Socket	B/C	5	3/4"	N/A
S52-10C	Size 10 Stainless Steel Socket	B/C	5	5/8"	N/A
S52-12C	Size 12 Stainless Steel Socket	B/C	5	3/4"	N/A
S53-8-10	Male Pipe End Size 8 For Size 10 Hose	D	5	5/8"	1/2"-14
S54-10-10	Female JIC Swivel - Size 10 For Size 10 Hose	E	5	5/8"	7/8"-14 Fem
S54-12-12	Female JIC Swivel - Size 12 For Size 12 Hose	E	5	3/4"	1 1/16"-14 Fem
S56-10-10	Straight Tube - Size 10 For Size 10 Hose	F	5	5/8"	N/A
S56-12-12	Straight Tube - Size 12 For Size 12 Hose	F	5	3/4"	N/A
S57-8-10	SAE Compression - Size 8 For Size 10 Hose	G	5	N/A	N/A
S57-10-10	SAE Compression - Size 10 For Size 10 Hose	G	5	5/8"	13/16"-18
S57-12-12	SAE Compression - Size 12 For Size 12 Hose	G	5	3/4"	1"-18

- Fittings comply with DOT & SAE J246 specifications

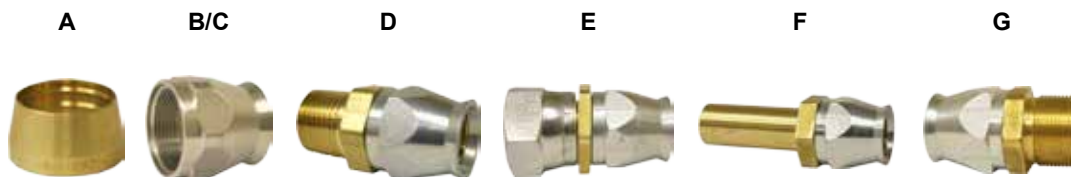

### Tramec

Rubber Hose Assemblies

Coiled Air Assemblies

3-in-1 & 4-in-1 Wraps

**Bulk Hose**

Air Compressor Discharge Hose Assemblies

Quick Fix™

Air Hose Accessories

Hose Clamps

Gladhands & Accessories

Air Tanks

Drain Valves

Ground Plugs

Truck Valves

Selector Valves

Brass Fittings

Hose & Tube Chart

Dash Control Valves

Air Brake Valves

Air Accessory Valves

Air Cylinders

Switches & Toggles

Plugs, Sockets & Cables

RV Plugs & Sockets

Wire & Cable

Electrical Harnesses

Electrical Connectors

Fuel Caps

Oil Caps & Dipsticks

Grease Fittings

Water Pumps

Wiper Blades

Engine Heaters

Link Cat's Eye®

Hub Caps, Axilok® & Securex®

Flitz

MAXXGreen



## Air Compressor Discharge Hose Assemblies

- Durable stainless steel braided outer jacket
- Temperature rating of -100°F to +450°F
- Extruded Teflon inner tube prevents carbon build-up
- 5/8" straight tube x 5/8" compression fitting
- Hose size - 5/8" O.D., 1/2" I.D.

Length	Sloan No.
18"	462018
24"	462024
30"	462030
36"	462036
48"	462048



- Female swivel both ends
- Hose size - 5/8" O.D., 1/2" I.D.

Length	Sloan No.
18"	462218
24"	462224
30"	462230
36"	462236
52"	462252
54"	462254
72"	462272
84"	462284



- 5/8" Compression fitting both ends
- Hose size - 5/8" O.D., 1/2" I.D.

Length	Sloan No.
18"	462318
24"	462324



- 5/8" straight tube both ends
- Hose size - 5/8" O.D., 1/2" I.D.

Length	Sloan No.
24"	462124
36"	462136



## 1/2" Quick-Fix®

Part No.	Description
431408	1/2" x 3/8" NPTF Hose Quick Fix Kit
431408-100	1/2" x 3/8" NPTF Hose Quick Fix, 100 pcs, Bulk Unpackaged
431410	1/2" x 1/2" NPTF Hose Quick Fix Kit
431410-100	1/2" x 1/2" NPTF Hose Quick Fix, 100 pcs, Bulk Unpackaged

- All brass construction of the sleeve and barb
- Permanent live swivel
- Available with 3/8" or 1/2" male fittings (for use with 1/2" rubber hose only)
- Pre-applied thread sealant
- Both barbs are greased to make installation easier
- Packaged in tubes for easy shelf display
- One package will repair two damaged 1/2" rubber air brake lines
- Each packaged tube contains step-by-step instructions for installation
- Made in the USA by American workers on American machines
- DOT FMVSS571.106



<b>Step 1.</b>  Trim the hose end and place the sleeve on until flush with the hose.	<b>Step 2.</b>  Place the greased barb into the sleeve end, push and turn barb hex to start the threads.	<b>Step 3.</b>  With the barb threads already started, hold sleeve and hose from turning. Align swivel hex and barb hex and place 7/8 deep well socket over swivel hex and on to barb hex. Screw the barb hex in using a socket wrench or crescent wrench.
<b>Step 4.</b>  OR  If necessary to keep the sleeve from turning, place crescent wrench on integrated hex flats and hold sleeve in place. Using a socket wrench or another wrench, place it on the barb hex and continue to push and turn until the barb hex is flush to the top of the sleeve.	<b>Step 5.</b>  OR  Once the barb hex is flush to the sleeve your hose end is complete and ready for installation.	

## Quick-Fix®

- One package will repair two damaged 3/8" rubber air brake lines.
- Available with 3/8" or 1/2" male fittings  
\* For use with 3/8" rubber hose only.
- Includes installation tool.
- Pre-applied thread sealant.
- Packaged in point of purchase display pack.
- Meets DOT 106 SAE J1402 requirements.
- Hose assemblies available with Quick-Fix® ends.

Sloan No.	Description
431402	Individual pack 3/8" fittings (2 assemblies)
431402-12	Box of (12) 3/8" individual packs
431402-100	100 pcs. 3/8" bulk unpackaged (no tool)
431403	Individual pack 1/2" fittings (2 assemblies)
431403-12	Box of (12) 1/2" individual packs
431403-100	100 pcs. 1/2" bulk unpackaged (no tool)
431405	Display with (12) 3/8" individual packs
431405D	Quick-fix display only
431406	Display with (12) 1/2" individual packs

\*See page 3 for installation instructions.



Quick-Fix Display Rack holds 12 Quick-Fix packages

- Tramec
- Rubber Hose Assemblies
- Coiled Air Assemblies
- 3-in-1 & 4-in-1 Wraps
- Bulk Hose
- Air Compressor Discharge Hose Assemblies
- Quick Fix™
- Air Hose Accessories
- Hose Clamps
- Gladhands & Accessories
- Air Tanks
- Drain Valves
- Ground Plugs
- Truck Valves
- Selector Valves
- Brass Fittings
- Hose & Tube Chart
- Dash Control Valves
- Air Brake Valves
- Air Accessory Valves
- Air Cylinders
- Switches & Toggles
- Plugs, Sockets & Cables
- RV Plugs & Sockets
- Wire & Cable
- Electrical Harnesses
- Electrical Connectors
- Fuel Caps
- Oil Caps & Dipsticks
- Grease Fittings
- Water Pumps
- Wiper Blades
- Engine Heaters
- Link Cat's Eye®
- Hub Caps, Axilok® & Securex®
- Flitz
- MAXXGreen



## MAXXDuty Pogo

Sloan No.	Description
451126	MAXXDuty Pogo Stick 42"
451127	MAXXDuty Pogo Stick 36"
451128	MAXXDuty Pogo Stick 22"
451126D	42" MAXXDuty Pogo With Display Stand

• Display includes a 42" MAXXDuty Pogo, the stand, and a washer and nut that helps secure the pogo to the stand.



The ONLY All-In-One Solution Available In The Marketplace

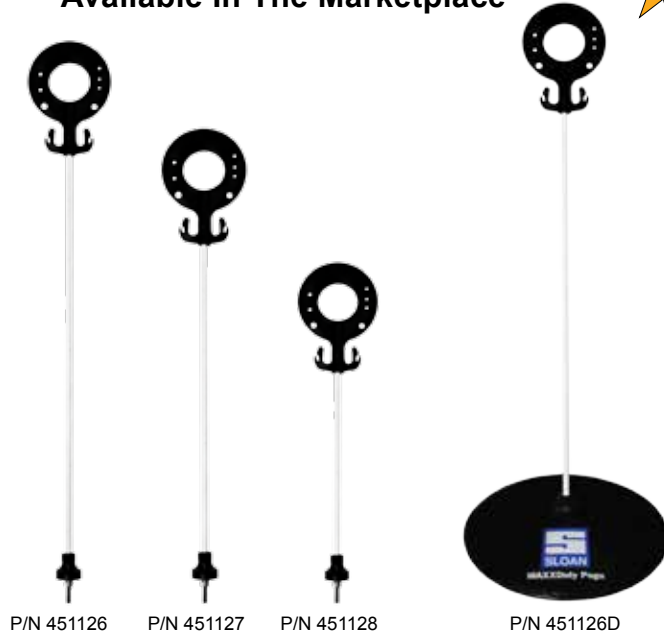

- Patented design features an extremely durable, injection molded, glass-filled nylon polymer top and base
- Allows for several attachment options
- Can be used with any heavy-duty line and cable configurations
- Rod is made in the USA of rigid, pultruded fiberglass
- All composite, nylon and fiberglass components are UV resistant
- Internal metal pieces are encapsulated in a protective casing
- Mounting bolt, nut and washer are zinc plated for corrosion resistance
- Ideally suited for Sloan's MAXXDuty 3-in-1 and 4-in-1 wraps

### Comparison Chart

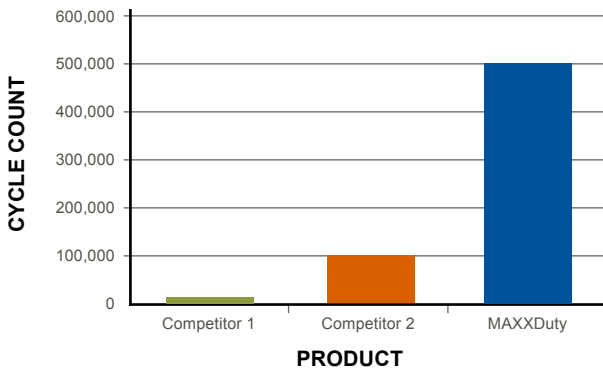

### Cycle Comparison

In rigorous cycle testing against competitive products, the Sloan MAXXDuty pogo has proven to outlast traditional spring-supported pogos by as much as 10 times in the harshest conditions with no signs of wear. In testing where traditional pogos wear and fail at 100,000 cycles or less, the innovative design of the MAXXDuty pogo has exceeded half a million cycles under the same conditions without failure.



## Fat Can Pogo Stick

### Features & Benefits

- New thicker gauge heavy duty spring
- New base is over 3 times larger
- Choice of chrome or zinc plated, dichromate steel support arm
- Larger 3.75" diameter housing eliminates spring binding
- Improved packaging. New heavy duty full overlap ECT 44 box
- Swivel arm pivots at base
- Forged steel mounting stud, 7/16-20
- All pogo sticks include eyebolt and nut



Sloan No.	Finish	Length	Hardware Included
451057	Chrome	45"	None
451058	Chrome	45"	451009 Clamp
451059	Zinc-Dichromate	45"	None
451060	Zinc-Dichromate	45"	451009 Clamp



Fat Can



Original



### Document Holders

Sloan No.	Description
422324	9" Aluminum Tube-Style Document Holder
422325	4" Round Holder w/ Twist-Lock

These document holders are durable and designed to keep your documents safe no matter what the condition.



422324



422325

- Tramec
- Rubber Hose Assemblies
- Coiled Air Assemblies
- 3-in-1 & 4-in-1 Wraps
- Bulk Hose
- Air Compressor Discharge Hose Assemblies
- Quick Fix™
- Air Hose Accessories**
- Hose Clamps
- Gladhands & Accessories
- Air Tanks
- Drain Valves
- Ground Plugs
- Truck Valves
- Selector Valves
- Brass Fittings
- Hose & Tube Chart
- Dash Control Valves
- Air Brake Valves
- Air Accessory Valves
- Air Cylinders
- Switches & Toggles
- Plugs, Sockets & Cables
- RV Plugs & Sockets
- Wire & Cable
- Electrical Harnesses
- Electrical Connectors
- Fuel Caps
- Oil Caps & Dipsticks
- Grease Fittings
- Water Pumps
- Wiper Blades
- Engine Heaters
- Link Cat's Eye®
- Hub Caps, Axilok® & Securex®
- Flitz
- MAXXGreen

## Tracker Bar Kit



Sloan No.	Description
451094*	43" Tracker Bar Kit, Includes 16" Tender Kit
451095*	36" Tracker Bar Kit, Includes 20" Tender Kit
451009	Clamp Assembly
451096	Carabiner
451069	Tender Spring Clip (5 pack)
451087	Spring Kit with 15" Support and 3 Hole Clamp
451711	16" tender kit with carabiner, spring, 3 hole clamp, & sleeve
451713	20" tender kit with carabiner, spring, 3 hole clamp & sleeve
451716	20" tender kit with carabiner, spring, & sleeve
451717	20" tender kit with 2 carabineers, 2 springs, 3 hole clamp & 2 sleeves
451718	20" tender kit with 2 carabineers, 2 springs & 2 sleeves
451719	20" tender kit with 2 carabineers, 3 springs, 3 hole clamp & 3 sleeves
451720	25" tender kit with carabiner, spring, 3 hole clamp, & sleeve
451721	25" tender kit with carabiner, spring, & sleeve
451722	25" tender kit with 2 carabineers, 2 springs, 3 hole clamp & 2 sleeves
451723	25" tender kit with 2 carabineers, 2 springs & 2 sleeves
451724	25" double Hydraulic tender kit with 2 springs, 2 sleeves, 2 carabineers & hanger bracket mounting assembly
451725	25" double Hydraulic tender kit with 2 springs, 2 sleeves, carabiner, and yoke
451726	25" sleeve only
451727	20" sleeve only
451728	16" sleeve only
451730	Yoke
451707	Slider bar
451708	Slider bar
451732	Slider bar with 20" double tender kit
451733	Slider bar with 25" single tender kit
451734	Slider bar with 25" double tender kit
451735	Slider bar with 20" double tender kit
451736	Slider bar with 25" single tender kit
451737	Slider bar with 25" double tender kit
451738	16" Tender kit w/ carabiner, spring, sleeve and 3/8" MAXXClamp
451739	16" Tender kit w/ carabiner, spring, sleeve and 1/2" MAXXClamp
451740	16" Tender kit w/ carabiner, 2 springs, 2 sleeves and 3/8" MAXXClamp
451741	16" Tender kit w/ carabiner, 2 springs, 2 sleeves and 1/2" MAXXClamp
451742	20" Tender kit w/ carabiner, spring, sleeve and 3/8" MAXXClamp
451743	20" Tender kit w/ carabiner, spring, sleeve and 1/2" MAXXClamp
451744	20" Tender kit w/ carabiner, 2 springs, 2 sleeves and 3/8" MAXXClamp
451745	20" Tender kit w/ carabiner, 2 springs, 2 sleeves and 1/2" MAXXClamp
451746	25" Tender kit w/ carabiner, spring, sleeve and 3/8" MAXXClamp
451747	25" Tender kit w/ carabiner, spring, sleeve and 1/2" MAXXClamp
451748	25" Tender kit w/ carabiner, 2 springs, 2 sleeves and 3/8" MAXXClamp
451749	25" Tender kit w/ carabiner, 2 springs, 2 sleeves and 1/2" MAXXClamp
451750	16" Tender kit w/ carabiner, 2 springs, 2 sleeves
451751	16" Tender kit w/ carabiner, 2 springs, 2 sleeves, 3 hole clamp
451752	16" Tender kit w/ carabiner, spring, sleeve

\* Includes Bar, Bag, 3 Hose Holder, 20" Spring, and Mounting Clip.

## Tender Springs

Style A



Style B



Sloan No.	Style	Length	O.D.	Wire
451046	A	13"	.75"	.0625"
451047	A	13"	1.00"	.080"
451048	A	15"	1.06"	.080"
451049	A	25"	1.06"	.080"
451706	A	15"		
451712	A	20"	1.06"	.080"
451729	A	16"		
451050	B	13"	.75"	.0625"
451051	B	13"	1.00"	.080"
451052	B	15"	1.06"	.080"
451053	B	25"	1.06"	.080"

# Air Hose Accessories



## Air Hose Clamps

Sloan No.	Hose I.D.	Description
451000	3/8"	3 Way
451001	3/8"	2 Way
451009	3/8"	3 Way



## Frame Clip

Sloan No.	Description
451088	Frame Clip



## Hose Hanger Assembly

Sloan No.	Hose I.D.	Description
451080	3/8"	2 Way (451001) with 451088 clip

## Air Hose Separator

- Can be mounted by cable tie or suspended by hose support spring
- Made of high-impact nylon

Sloan No.	Description
451037•	for 3/8" Air Hose
451038•	for 1/2" Air Hose

- Item available as 100 pieces in one box. Order part number with suffix -100.



## Nylon Tube Cutter

Sloan No.	Description
451100	Accepts up to 5/8" nylon tubing



## Rubber Tarp Straps

- 98.8% stretch recovery after being stretched 150% of original length
- Packaged with "S" hooks attached

Sloan No.	Relaxed Length
490000	9"
490001	15"
490002	21"
490003	31"
490004	41"
490005	"S" hook only



\*Available in boxes of 50. Add a -50 to the suffix of the part number for a box of 50.

Tramec
Rubber Hose Assemblies
Coiled Air Assemblies
3-in-1 & 4-in-1 Wraps
Bulk Hose
Air Compressor Discharge Hose Assemblies
Quick Fix™
Air Hose Accessories
Hose Clamps
Gladhands & Accessories
Air Tanks
Drain Valves
Ground Plugs
Truck Valves
Selector Valves
Brass Fittings
Hose & Tube Chart
Dash Control Valves
Air Brake Valves
Air Accessory Valves
Air Cylinders
Switches & Toggles
Plugs, Sockets & Cables
RV Plugs & Sockets
Wire & Cable
Electrical Harnesses
Electrical Connectors
Fuel Caps
Oil Caps & Dipsticks
Grease Fittings
Water Pumps
Wiper Blades
Engine Heaters
Link Cat's Eye®
Hub Caps, Axilok® & Securex®
Flitz
MAXXGreen



## MAXXClamp

- Self adjusting one piece clamp resulting in no loose parts which makes for easy installation
- Fast, efficient way to connect and disconnect hoses
- Three different clamping options to best hold your hoses
- One assembly with two pieces that pivot for three different hose diameters with three different positions
- No tools required
- For 3/8" and 1/2" hose
- Carabiner included
- Patent pending

Hang Your Air & Electrical Lines In 3 Easy Steps Using The MAXXClamp!

Sloan No.	Description
451169	MAXXClamp for 3/8" Hose
451178	MAXXClamp for 1/2" Hose

**STEP 1**  
Open The MAXXClamp To The Set Position



**STEP 2**  
Place The Service, Emergency, & Electrical Lines In The MAXXClamp



**STEP 3**  
Close The MAXXClamp And Add The Carabiner. Then Hang From Your Spring

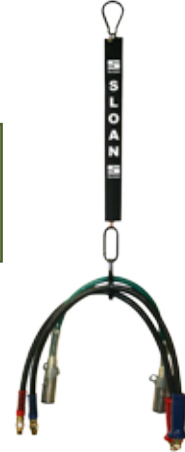

Air Products

## The "Puck" Hose Separator

- Separates air and electrical lines and eliminates the chance of rubbing
- No tool required for installation
- Will not rust or corrode
- Gives the user the chance to create their own "wrap"
- Can be used from the cab to the trailer and also under the trailer
- Safer way of seeing if there are any hose defects by being able to see the lines
- The separator keeps the lines organized and less chance of kinking
- Only available for 3/8" hose
- Recommend one separator for every foot when creating your "wrap"

Sloan No.	Description
451170	Separator for 3/8" Hose

\* Standard Pack 5



# Hose Clamps

## Hose Clamps

- All clamps manufactured with 300 series stainless steel
- Slotted hex head screws included on miniature, general purpose, and liner clamps

Miniature Clamps	General Purpose	Liner Clamps	Euro Seal	SAE Size	Clamping Range (in.)
490404	-----	-----	-----	4	7/32 - 5/8
490406	491006	491206	-----	6	7/32 - 25/32
-----	491008	491208	491708	8	1/2 - 29/32
-----	491010	491210	-----	10	9/16 - 1 1/16
-----	491012	491212	491712	12	1 1/16 - 1 1/4
-----	491016	491216	491716	16	13/16 - 1 1/2
-----	491020	491220	491720	20	13/16 - 1 3/4
-----	491024	491224	491724	24	1 1/16 - 2
-----	491028	491228	491728	28	1 5/16 - 2 1/4
-----	491032	491232	-----	32	1 9/16 - 2 1/2
-----	491036	491236	491736	36	1 13/16 - 2 3/4
-----	491040	491240	491740	40	2 1/16 - 3
-----	491044	491244	491744	44	2 5/16 - 3 1/4
-----	491048	491248	491748	48	2 9/16 - 3 1/2
-----	491052	-----	491752	52	2 13/16 - 3 3/4
-----	491056	-----	-----	56	3 1/16 - 4
-----	491060	-----	491760	60	3 5/16 - 4 1/4
-----	491064	-----	-----	64	3 9/16 - 4 1/2
-----	491072	-----	491772	72	4 1/16 - 5
-----	491080	-----	491780	80	4 9/16 - 5 1/2
-----	491088	-----	-----	88	5 1/16 - 6
-----	491096	-----	-----	96	5 9/16 - 6 1/2
-----	491104	-----	4917104	104	6 1/16 - 7

Miniature



General Purpose



Liner



Euro Seal



## Hose Clamp Rack Display

- Wall mounted or standing

Clamp Rack Assortment	Clamp Rack Empty
491700	491701



## 491700 Hose Clamp Assortment

Part No.	SAE Size	Qty.
490404	4	30
490406	6	30
491010	10	20
491012	12	20
491020	20	20
491024	24	20
491028	28	20
491032	32	20
491036	36	20

- Tramec**
- Rubber Hose Assemblies**
- Coiled Air Assemblies**
- 3-in-1 & 4-in-1 Wraps**
- Bulk Hose**
- Air Compressor Discharge Hose Assemblies**
- Quick Fix™**
- Air Hose Accessories**
- Hose Clamps**
- Gladhands & Accessories**
- Air Tanks**
- Drain Valves**
- Ground Plugs**
- Truck Valves**
- Selector Valves**
- Brass Fittings**
- Hose & Tube Chart**
- Dash Control Valves**
- Air Brake Valves**
- Air Accessory Valves**
- Air Cylinders**
- Switches & Toggles**
- Plugs, Sockets & Cables**
- RV Plugs & Sockets**
- Wire & Cable**
- Electrical Harnesses**
- Electrical Connectors**
- Fuel Caps**
- Oil Caps & Dipsticks**
- Grease Fittings**
- Water Pumps**
- Wiper Blades**
- Engine Heaters**
- Link Cat's Eye®**
- Hub Caps, Axilok® & Securex®**
- Flitz**
- MAXXGreen**



Part Number	Clamping Range
491450	2 1/2 - 2 13/16
491451	2 3/4 - 3 1/16
491452	3 - 3 5/16
491453	3 1/4 - 3 9/16
491454	3 7/16 - 3 7/8
491455	3 3/4 - 4 1/16
491456	4 1/4 - 4 9/16
491457	4 3/4 - 5 1/16
491458	5 1/4 - 5 9/16
491459	5 3/4 - 6 1/16
491460	6 1/4 - 6 9/16
491461	4 1/4 - 7 9/16
491462	8 1/2 - 8 13/16

## Standard T-Bolt

- Designed for use on engine air-intake.
- Constructed to endure high engine and turbo temperatures.



## Constant Torque

Part Number	Clamping Range
491310	9/16 - 1 1/16
491312	1 1/16 - 1 1/4
491316	13/16 - 1 1/2
491320	13/16 - 1 3/4
491324	1 1/16 - 2
491300	1 1/4 - 2 1/8
491325	1 3/4 - 2 5/8
491330	2 1/4 - 3 1/8
491335	2 3/4 - 3 5/8
491340	3 1/4 - 4 1/8
491345	3 3/4 - 4 5/8
491350	4 1/4 - 5 1/8
491355	4 3/4 - 5 5/8
491360	5 1/4 - 6 1/8

- Designed to eliminate cold flow hose leaks.
- Self-adjusting.



## Spring Loaded T-Bolt

Part Number	Clamping Range
491503	3 1/16" - 3 3/8"
491504	4 1/16" - 4 3/8"
491505*	3 1/16" - 3 3/8"
491506*	4 1/16" - 4 3/8"

- For use on charged-air-cooling or air-to-air aftercooled applications.



\* Heavy duty style

# Hose Clamps

## Turbo V-Band

- Designed to connect exhaust pipe flange to turbo or engine manifold.
- Constructed to endure high engine and turbo temperatures.

Sloan No.	Nominal	A	B	C	D	E	Applications
491620	3.21"	.050	.262	.141	.035	.750	Cummins, Freightliner, Bluebird Bus, Ford, Oshkosk
491621	3.82"	.077	.207	.281	.040	.875	CAT, GMC, Ford, DDC, Navistar
491622	3.88"	.050	.400	.281	.040	.875	Volvo, Cummins, Ford
491623	4.50"	.077	.207	.281	.040	.875	GMC, DDC, Navistar
491624	4.61"	.050	.156	.218	.035	.750	Mack, Switzer
491625	4.75"	.077	.158	.310	.040	.875	CAT, Cummins, Freightliner, Volvo, GMC, Western Star
491626	5.25"	.050	.262	.141	.035	.750	Freightliner, Navistar, DDC
491627	5.88"	.050	.400	.281	.040	.875	Cummins, DDC, CAT
491628	5.88"	.050	.400	.281	.040	.875	Same as 491627 except it is a 1-piece economy version.

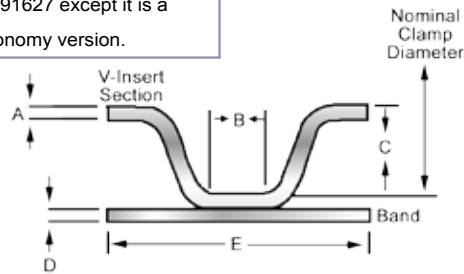

## 1/4" Nylon Clamps

Part Number	Description
492100	1/4" x 3/16"
492101	1/4" x 1/4"
492102	1/4" x 5/16"
492103	1/4" x 3/8"
492104	1/4" x 7/16"
492105	1/4" x 1/2"
492106	1/4" x 9/16"
492107	1/4" x 5/8"
492108	1/4" x 3/4"
492109	1/4" x 7/8"
492110	1/4" x 1"
492111	1/4" x 1 - 1/8"
492112	1/4" x 1 - 1/4"
492113	1/4" x 1 - 3/8"



## 1/4" Rubber Clamps

Part Number	Description
492000	1/4" x 1/4"
492001	1/4" x 3/8"
492002	1/4" x 1/2"
492003	1/4" x 5/8"
492004	1/4" x 3/4"
492005	1/4" x 7/8"
492006	1/4" x 1"
492007	1/4" x 1 - 1/8"
492008	1/4" x 1 - 1/4"
492009	1/4" x 2 - 1/2"



- Tramec**
- Rubber Hose Assemblies**
- Coiled Air Assemblies**
- 3-in-1 & 4-in-1 Wraps**
- Bulk Hose**
- Air Compressor Discharge Hose Assemblies**
- Quick Fix™**
- Air Hose Accessories**
- Hose Clamps**
- Gladhands & Accessories**
- Air Tanks**
- Drain Valves**
- Ground Plugs**
- Truck Valves**
- Selector Valves**
- Brass Fittings**
- Hose & Tube Chart**
- Dash Control Valves**
- Air Brake Valves**
- Air Accessory Valves**
- Air Cylinders**
- Switches & Toggles**
- Plugs, Sockets & Cables**
- RV Plugs & Sockets**
- Wire & Cable**
- Electrical Harnesses**
- Electrical Connectors**
- Fuel Caps**
- Oil Caps & Dipsticks**
- Grease Fittings**
- Water Pumps**
- Wiper Blades**
- Engine Heaters**
- Link Cat's Eye®**
- Hub Caps, Axilok® & Securex®**
- Flitz**
- MAXXGreen**



## MAXXGrip Dura-Grip Gladhand Combo



The New MAXXGrip Offers A Revolutionary New Approach To Ensuring Safer And More Complete Connections With Critical Airlines.

**Some Of The Benefits Of The New MAXXGrip Include:**

- Safer And More Complete Connections
- Integrated Hex At The Base For Ease Of Installation
- Ergonomic Grip Reducing The Chance Of Kinking Airlines And Extending Their Life
- Easier Coupling And Uncoupling With Added Leverage
- Eliminates Potential For Leaking Between Connections
- Constructed Of Durable Die Cast Aluminum With Stainless Steel Wear Plate. Also Available In Powder Coated Red Or Blue.
- Colored Powder Coating Available For Easy Identification

Sloan No.	Description
441226	Gladhand Dura-Grip Combo, Powder Coated Blue, Service
441227	Gladhand Dura-Grip Combo, Powder Coated Red, Emergency
441222	Gladhand Dura-Grip Combo, Red, Emergency
441223	Gladhand Dura-Grip Combo, Blue, Service
441228	Gladhand Dura-Grip, Display 2 Pack, 1 Service and 1 Emergency
441229	Gladhand Dura-Grip, Display 2 Pack Powder Coated, 1 Service and 1 Emergency



Display 2 Pack Powder Coated



# Gladhands & Accessories



## Rapid-Release™ Service Gladhand

- Releases trailer brakes up to 50% faster than standard methods.
- Available in both standard and 37.5° mount.
- Prevents in-city trailer bounce.
- Reduces wear on drums resulting in maintenance savings.
- Meets SAE J318 specifications.
- Includes polyurethane seal.
- Regular equipment on the majority of OEM trailers



Part No.	Configuration	Seal Type	Remarks
441175	standard	poly	w/ filter
441176	standard	poly	
441177	angle mount	poly	w/ filter
441178	angle mount	poly	

## Rapid-Release™ Service Kit

Part No.	Description
451715	Rapid Release Gasket Service Kit -includes gasket, snap ring, and diaphragm



## Rapid-Release™ Swing-Away

Part No.	Description
441233	Rapid Release Swing-Away Gladhand

- 180° swivel rotation
- Includes polyurethane seal with filter
- Will return to closed position when not in use

## Standard Gladhands

- Constructed of die cast aluminum with stainless steel wear plates.
- Service and Emergency configurations (polarized) or Universal (non-polarized).
- Available with polyurethane color coded seals.

## Why Use Gladhands with Polyurethane Seals?

- Polyurethane seals will not crack, tear or dry out like rubber seals.
- Polyurethane seals have a reverse taper-eliminates the possibility of the seal lip folding over.
- Polyurethane seals are available color coded-reduces chance of hookup error.
- Polyurethane seals are pliable in all weather conditions.



Service



Emergency



Universal

Sloan No.	Configuration	Seal Type	Remarks
441015...	service	rubber	
441016...	emergency	rubber	
441017...	universal	rubber	
441050...	emergency	rubber	w/ filter
441051...	service	rubber	w/ filter
441056...	service	blue poly	
441057...	emergency	red poly	
441058...	service	black poly	
441059...	emergency	black poly	
441060...	universal	black poly	
441145	universal	rubber	1/4" main port

... Item available as 100 pieces in one box. Order with suffix -100.

Tramec
Rubber Hose Assemblies
Coiled Air Assemblies
3-in-1 & 4-in-1 Wraps
Bulk Hose
Air Compressor Discharge Hose Assemblies
Quick Fix™
Air Hose Accessories
Hose Clamps
Gladhands & Accessories
Air Tanks
Drain Valves
Ground Plugs
Truck Valves
Selector Valves
Brass Fittings
Hose & Tube Chart
Dash Control Valves
Air Brake Valves
Air Accessory Valves
Air Cylinders
Switches & Toggles
Plugs, Sockets & Cables
RV Plugs & Sockets
Wire & Cable
Electrical Harnesses
Electrical Connectors
Fuel Caps
Oil Caps & Dipsticks
Grease Fittings
Water Pumps
Wiper Blades
Engine Heaters
Link Cat's Eye®
Hub Caps, Axilok® & Securex®
Flitz
MAXXGreen



## Powder Coated Gladhands

Sloan No.	Configuration	Seal	
		Type	Remarks
441078***	service	blue poly	powder-coated body
441079***	emergency	red poly	powder-coated body
441093***	service	black poly	powder-coated body
441094***	emergency	black poly	powder-coated body

\*\*\* Item available as 100 pieces in one box. Order with suffix -100.

## Bulk Head Shut-off Gladhand

- Die cast aluminum construction
- Emergency gladhand has 1/4" port for pintle hook

Sloan No.	Description
441148	service with 3/8" nylon tube fitting
441149	emergency with 3/8" nylon tube fitting
441161	service with 1/2" nylon tube fitting
441161L	service with 1/2" nylon tube fitting, w/ long handle
441162	emergency with 1/2" nylon tube fitting
441162L	emergency with 1/2" nylon tube fitting, w/ long handle
441164	service with 3/8" NPTF Port
441164L	service with 3/8" NPTF Port, w/ long handle
441165	emergency with 3/8" NPTF Port
441165L	emergency with 3/8" NPTF Port, w/ long handle

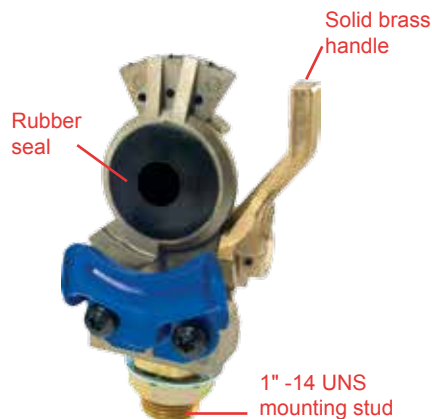

## Cast Iron Gladhands

- Constructed of die cast malleable iron.
- Comes standard with polyurethane seal.



Sloan No.	Configuration	Seal Type	Remarks
441088•	emergency	red poly	2-piece design
441089•	emergency	black poly	2-piece design
441090•	service	blue poly	2-piece design
441091•	service	black poly	2-piece design
441092•	universal	black poly	2-piece design
441131•	service	blue poly	1-piece design
441132•	emergency	red poly	1-piece design
441133•	universal	black poly	1-piece design
441818	emergency	red poly	2-piece design powder coated
441819	service	blue poly	2-piece design powder coated
441820	service	blue poly	1-piece design powder coated
441821	emergency	red poly	1-piece design powder coated

• Item available as 40 pieces in one box. Order with suffix -40.

## Shut-Off Composite Gladhands

Sloan No.	Description
GH1004	Composite service gladhand with blue polyurethane seal
GH1014	Composite emergency gladhand with red polyurethane seal



## Shut-Off Style Gladhands

Sloan No.	Configuration	Plug	Fitting	Seal
441000	service	not req'd	3/8" copper	rubber
441001•	service	not req'd	3/8" nylon	rubber
441003•	service	not req'd	1/2" nylon	rubber
441004•	service	not req'd	none	rubber
441005•	emergency	yes	3/8" copper	rubber
441007•	emergency	no	3/8" copper	rubber
441008•	emergency	no	3/8" nylon	rubber
441012•	emergency	no	1/2" nylon	rubber
441014•	emergency	no	none	rubber
441071	emergency	not req'd	3/8"-18 port	red poly
441072	service	not req'd	3/8"-18 port	blue poly
441080	emergency	not req'd	3/8"-18 port	black poly
441081	service	not req'd	3/8"-18 port	black poly
441205	service	not req'd	1/2" nylon	rubber protect-o, no filter
441206	emergency	not req'd	1/2" nylon	rubber protect-o, no filter
441207	service	no	none	rubber protect-o
441208	emergency	no	none	rubber protect-o
441224	service	not req'd	none	black poly protect-o, w/ filter
441225	emergency	not req'd	none	black poly protect-o, w/ filter

• Item available as 50 pieces in one box. Order with suffix -50.



Gladhands with poly protect-o seals help eliminate contaminating particles from entering the air stream. The filter is added for additional air stream protection.

\* All Sloan Shut-Off Gladhands include a gasket that is to be mounted between the gladhand base and the trailer. This gasket will help prevent corrosion on the mounting surface between the trailer and the gladhand.

## Swing-Away/Shut-off Gladhand™

- Shut-off valve prevents contaminants from entering the system.
- Eliminates the need for a dummy coupler.
- Decreases plumbing hardware and speeds installation time.



Sloan No.	Configuration	Seal Type	Remarks
441171	service	black poly	Cast Aluminum Gladhand
441172	emergency	black poly	Cast Aluminum Gladhand
441169	service	blue poly	Cast Iron Gladhand
441170	emergency	red poly	Cast Iron Gladhand

- Tramec
- Rubber Hose Assemblies
- Coiled Air Assemblies
- 3-in-1 & 4-in-1 Wraps
- Bulk Hose
- Air Compressor Discharge Hose Assemblies
- Quick Fix™
- Air Hose Accessories
- Hose Clamps
- Gladhands & Accessories
- Air Tanks
- Drain Valves
- Ground Plugs
- Truck Valves
- Selector Valves
- Brass Fittings
- Hose & Tube Chart
- Dash Control Valves
- Air Brake Valves
- Air Accessory Valves
- Air Cylinders
- Switches & Toggles
- Plugs, Sockets & Cables
- RV Plugs & Sockets
- Wire & Cable
- Electrical Harnesses
- Electrical Connectors
- Fuel Caps
- Oil Caps & Dipsticks
- Grease Fittings
- Water Pumps
- Wiper Blades
- Engine Heaters
- Link Cat's Eye®
- Hub Caps, Axilok® & Securex®
- Flitz
- MAXXGreen

## Swing-Away Gladhands

- Provides the lowest projection height from "trailer skin".
- Eliminates the need to "twist" hoses to obtain gladhand retraction.
- 180° swivel designed elbow permits optional air line entry from either the bottom or back port.
- Eliminates expensive swivel type hoses and permits the use of inexpensive nylon reinforced tubing.
- Gladhand bracket prevents foreign particles and insects from entering air lines while trailer is not in use.
- Bottom Port - 3/8"-18 NPTF
- Back Port - 3/8"-18 NPTF

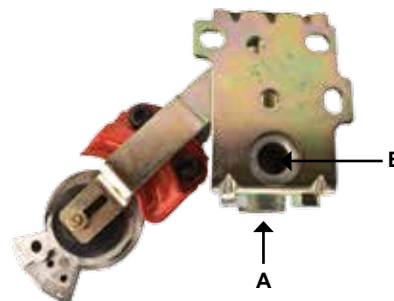

**\*\*See Page 75 for a Rapid Release Swing-Away Gladhand\*\***

Air Products

Sloan No.	Configuration	Seal Type	Gladhand Material	Port A	Port B
441062	service swivel - bottom port air hookup	black poly	aluminum	open	plugged
441063	emergency swivel - bottom port air hookup	black poly	aluminum	open	plugged
441064	universal swivel - bottom port air hookup	black poly	aluminum	open	plugged
441069	emergency swivel - bottom port air hookup	red poly	aluminum	open	plugged
441070	service swivel - bottom port air hookup	blue poly	aluminum	open	plugged
441102	service swivel - back port air hookup	black poly	aluminum	plugged	open
441103	emergency swivel - back port air hookup	black poly	aluminum	plugged	open
441104	universal swivel - back port air hookup	black poly	aluminum	plugged	open
441105	emergency swivel - back port air hookup	red poly	aluminum	plugged	open
441106	service swivel - back port air hookup	blue poly	aluminum	plugged	open
441150	service swivel - bottom port air hookup	blue poly	cast iron	open	plugged
441151	emergency swivel - bottom port air hookup	red poly	cast iron	open	plugged
441152	service swivel - back port air hookup	blue poly	cast iron	plugged	open
441153	emergency swivel - back port air hookup	red poly	cast iron	plugged	open
441154	service swivel - both ports open	blue poly	cast iron	open	open
441155	emergency swivel - both ports open	red poly	cast iron	open	open



Swing-Away Gladhand Rotates A Full 180° For Easy Air Line Coupling.

## 37-1/2° Bracket Mount Gladhands

Sloan No.	Configuration	Seal Type	Remarks
441018***	emergency	rubber	with filter
441019***	emergency	rubber	
441022***	service	rubber	with filter
441023***	service	rubber	
441065***	emergency	red poly	
441066***	service	blue poly	
441067***	service	blue poly	blue powder-coated body
441068***	emergency	red poly	red powder-coated body
441074***	emergency	red poly	with filter
441075***	service	blue poly	with filter
441083***	emergency	black poly	
441085***	service	black poly	
441098**	service	blue poly	blue painted body, stainless steel clamp
441099**	emergency	red poly	red painted body, stainless steel clamp



\*\* Item available as 63 pieces in one box. Order with suffix -63.  
 \*\*\* Item available as 80 pieces in one box. Order with suffix -80.

## Dummy Gladhand

Sloan		
No.	Description	Item
441167	Stamped, Non-vented	A
441168	Stamped, Vented	A
441047•	Non-vented w/ 26" cable	B
441822	Solid Casting w/ 16" cable	C

• Item available as 50 pieces in one box, order with suffix -50.

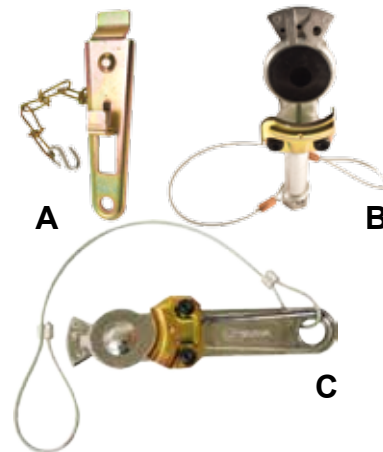

## Gladhand Pacifier

- Keeps airlines and exposed gladhands free from dirt, insects and moisture.
- 2-piece nylon strap keeps pacifier handy when the airline system is connected or disconnected.
- Can be used on any Sloan or other make gladhands.



Sloan	
No.	Description
441721	Gladhand pacifier

## Gladhand Seal Tool

Sloan	
No.	Description
441823	Gladhand Seal Removal & Insert Tool

Designed to provide a safe and easier way of removing and inserting gladhand seals.



## Gladhand Seals

Sloan	
No.	Description
441095	polyurethane gladhand seal display board 12" x 18", 24 pkgs (2-blue/2 red per pack)
441095D	polyurethane display w/out stock
441095P	24 re-fill packages for poly-seal display
441749•	gladhand full face type seal
441736•	gladhand protect-o seal
441737•	gladhand red polyurethane seal
441738•	gladhand blue polyurethane seal
441739•	gladhand black polyurethane seal

• Item available as 100 pieces in one box, order with suffix -100.

Part	
No.	Description
GH5500	Blue poly seal with built-in stainless steel filter
GH6600	Red poly seal with built-in stainless steel filter
GH7700	Black poly seal with built-in stainless steel filter



## Polyurethane Filter Combo



Tramec
Rubber Hose Assemblies
Coiled Air Assemblies
3-in-1 & 4-in-1 Wraps
Bulk Hose
Air Compressor Discharge Hose Assemblies
Quick Fix™
Air Hose Accessories
Hose Clamps
Gladhands & Accessories
Air Tanks
Drain Valves
Ground Plugs
Truck Valves
Selector Valves
Brass Fittings
Hose & Tube Chart
Dash Control Valves
Air Brake Valves
Air Accessory Valves
Air Cylinders
Switches & Toggles
Plugs, Sockets & Cables
RV Plugs & Sockets
Wire & Cable
Electrical Harnesses
Electrical Connectors
Fuel Caps
Oil Caps & Dipsticks
Grease Fittings
Water Pumps
Wiper Blades
Engine Heaters
Link Cat's Eye®
Hub Caps, Axilok® & Securex®
Flitz
MAXXGreen



## Tire Inflator / Cab Blower

Complete assembly includes:

- 1/4" NPT Universal gladhand - 441145
- 50' HD air line, with 1/4" NPT
- 1/4" NPT tire inflator and 1/4" blow gun

Sloan	
No.	Description
451102	Complete assembly
451103	Bulk 3/8" tubing, 50' long, 1/4" NPT
451104	Tire inflator, 1/4" NPT
451105	Blow gun, 1/4" NPT



Rubber Hose



## Gladhand Lock

- Prevents unwanted trailer connections.
- 2 lock combinations available with 2 keys.
- Fits most makes of gladhands.

Sloan No.	Key No.
441752-01	01
441752-03	03



## King Pin Lock

- Prevents unwanted trailer connection

Sloan	
No.	Description
451101	Supplied with 2 keys



## Gladhand Accessories

Sloan	
No.	Description
441704	gladhand w/shut-off cock replacement handle roll pin
441731	gladhand holder
441750	replacement handle for shut-off style gladhand (4.50" length)
441766	replacement dust cover for swing-away gladhand
441134	screen filter



441766



441731

## Gladhand/7-Way Plug Holder

- Constructed of durable ABS plastic.
- Keeps gladhands and electrical plugs out of dirt, grease and other contaminants.
- Mounts with plugs pointing down to prevent moisture from gathering...reducing corrosion.

Sloan	
No.	Description
441747	holds electrical plug and two gladhand
441748*	holds two electrical plugs and two gladhands

\*4-function holder used for brake systems equipped with ABS.



441748  
4-Function Holder



441747  
3-Function Holder

# Gladhands & Accessories



## Aluminum Dura-Grip™

- Durable. Attractive. Functional.
- Red and Blue protective finish.
- Easy to install.

Sloan No.	Connections	
	Airline	Gladhand
441799	1/2" NPTF Female	1/2" NPTF Male

• Item available as 12 pieces in one box. Order with suffix -12.



## Dura-Grip™

- Installs in minutes between the gladhand and airline with standard tools.
- Color coded blue and red plastic handles resist cracking in subzero temperatures.
- Prevents kinking of airlines at the gladhand connection.
- Includes all mounting hardware.
- Fits most tractor airlines.
- Thread sealant pre-applied on all fittings prevents air leaks.
- Packaged in point of purchase display pack.



Sloan No.	Connections	
	Airline	Gladhand
441751•	1/2" NPTF Female	1/2" NPTF Male

• Item available as 12 pieces in one box. Order with suffix -12.

## Dura-Grip™ Display Rack

- Attractive Sloan header.
- Holds 12 sets of Dura-Grip packages.
- Stands on counter-top or can be wall mounted.

<b>Display Rack Empty</b>
441129*

\* Available FREE with initial order of twelve Dura-Grips (441751-12).

<b>Display Rack With Stock</b>
441130**

\*\*Includes twelve Dura-Grips (441751-12).



<b>Tramec</b>
<b>Rubber Hose Assemblies</b>
<b>Coiled Air Assemblies</b>
<b>3-in-1 &amp; 4-in-1 Wraps</b>
<b>Bulk Hose</b>
<b>Air Compressor Discharge Hose Assemblies</b>
<b>Quick Fix™</b>
<b>Air Hose Accessories</b>
<b>Hose Clamps</b>
<b>Gladhands &amp; Accessories</b>
<b>Air Tanks</b>
<b>Drain Valves</b>
<b>Ground Plugs</b>
<b>Truck Valves</b>
<b>Selector Valves</b>
<b>Brass Fittings</b>
<b>Hose &amp; Tube Chart</b>
<b>Dash Control Valves</b>
<b>Air Brake Valves</b>
<b>Air Accessory Valves</b>
<b>Air Cylinders</b>
<b>Switches &amp; Toggles</b>
<b>Plugs, Sockets &amp; Cables</b>
<b>RV Plugs &amp; Sockets</b>
<b>Wire &amp; Cable</b>
<b>Electrical Harnesses</b>
<b>Electrical Connectors</b>
<b>Fuel Caps</b>
<b>Oil Caps &amp; Dipsticks</b>
<b>Grease Fittings</b>
<b>Water Pumps</b>
<b>Wiper Blades</b>
<b>Engine Heaters</b>
<b>Link Cat's Eye®</b>
<b>Hub Caps, Axilok® &amp; Securex®</b>
<b>Flitz</b>
<b>MAXXGreen</b>

Tramec Sloan Air Tanks have you covered – literally inside and out. You probably already knew that Sloan meets the SAE J10 Specification for Air Brake Reservoirs. However did you also know that Sloan employs an advanced 3-Step Exterior finishing process and a new industry leading Interior finish to help you fight CORROSION? Our Exterior finish has passed 250+ hours of testing to the ASTM B117-95 Salt Spray standard; the requirement in SAE J10 is 48 hours. Our new Interior corrosion protection strategy was adapted from marine and military applications and features a self-healing barrier that not only passes the same 250+ hours of ASTM B117-95 testing, but also meets the stringent military spec MIL-PRF-16173 Grade 2. Tramec Sloan Air Tanks when paired with a Tramec Sloan drain valve can ensure years of trouble free operation.

#### Tank Specifications:

7" Diameter	800 in <sup>3</sup> (3.46 gallons)
8" Diameter	1425 in <sup>3</sup> (6.16 gallons)
9.5" Diameter	1488 in <sup>3</sup> (6.44 gallons)
12" Diameter	2850 in <sup>3</sup> (12.34 gallons)
12" Diameter (Special)	4400 in <sup>3</sup> (19.05 gallons)

#### Specifications:

- 150 PSI Working Pressure
- All ports are NPT
- Meets and Exceeds all SAE J10B Specifications



# Air Tanks

## Air Tanks

- 150 PSI working pressure.
- Threaded ports are standard NPT.
- Conforms to SAE J10B specifications.

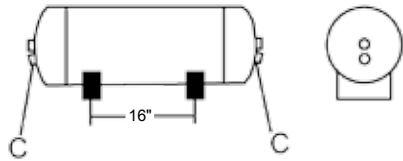

7" dia. Air Tank  
800 cubic inch capacity (3.46 Gallons)

Sloan No.	Length	Main Port	Drain Port	End Port
461020	22"	---	---	1/2"

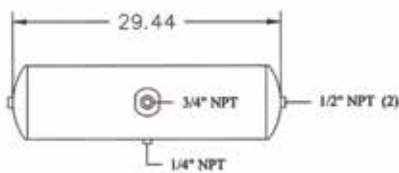

8" dia. Air Tanks  
1425 cubic inch capacity (6.16 Gallons)

Sloan No.	Length	Main Port	Drain Port	End Port
461006	29.44"	3/4"	1/4"	1/2"

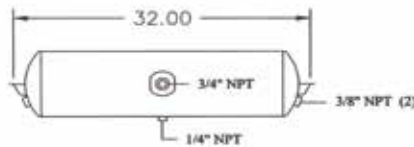

Sloan No.	Mtg. Hole Centers	Main Port	Drain Port	End Port
461007*	32.0"	3/4"	1/4"	3/8"

\*Item is available as 26 pieces on a skid. Order part number with suffix -26.

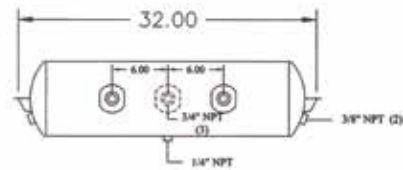

Sloan No.	Length	Main Port	Drain Port	End Port
*461023	32.0"	3/4" (2)	1/4"	3/8"

\*Additional 3/4" main port (A) opposite of port shown.

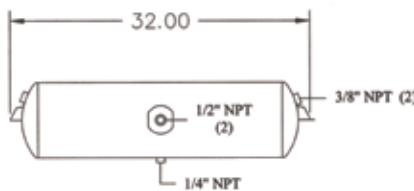

Sloan No.	Mtg. Hole Centers	Main Port	Drain Port	End Port
*461026	32.0"	1/2"	1/4"	3/8"

\*Additional 1/2" main port (A) opposite of port shown.

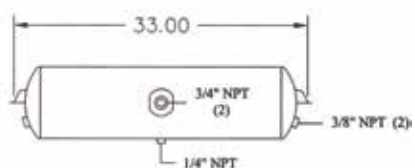

Sloan No.	Mtg. Hole Centers	Main Port	Drain Port	End Port
*461027	33.0"	3/4"	1/4"	3/8"

\*Additional 3/4" main port (A) opposite of port shown.

- Tramec
- Rubber Hose Assemblies
- Coiled Air Assemblies
- 3-in-1 & 4-in-1 Wraps
- Bulk Hose
- Air Compressor Discharge Hose Assemblies
- Quick Fix™
- Air Hose Accessories
- Hose Clamps
- Gladhands & Accessories
- Air Tanks**
- Drain Valves
- Ground Plugs
- Truck Valves
- Selector Valves
- Brass Fittings
- Hose & Tube Chart
- Dash Control Valves
- Air Brake Valves
- Air Accessory Valves
- Air Cylinders
- Switches & Toggles
- Plugs, Sockets & Cables
- RV Plugs & Sockets
- Wire & Cable
- Electrical Harnesses
- Electrical Connectors
- Fuel Caps
- Oil Caps & Dipsticks
- Grease Fittings
- Water Pumps
- Wiper Blades
- Engine Heaters
- Link Cat's Eye®
- Hub Caps, Axilok® & Securex®
- Flitz
- MAXXGreen

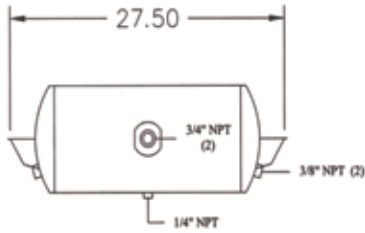

9.5" dia. Air Tanks  
1488 cubic inch capacity (6.44 Gallons)

Sloan No.	Mtg. Hole Centers	Main Port (A)	Drain Port (B)	End Port (C)
*461003*	27.5"	3/4"	1/4"	3/8"

\*Additional 3/4" main port (A) opposite of port shown.  
• Item is available as 22 pieces on a skid. Order part number with suffix -22.

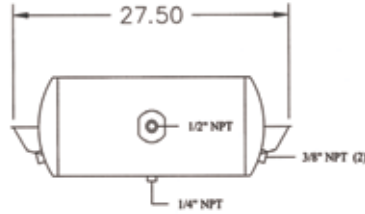

Sloan No.	Mtg. Hole Centers	Main Port (A)	Drain Port (B)	End Port (C)
461001	27.5"	1/2"	1/4"	3/8"
461005*	27.5"	3/4"	1/4"	3/8"

• Item is available as 22 pieces on a skid. Order part number with suffix -22.

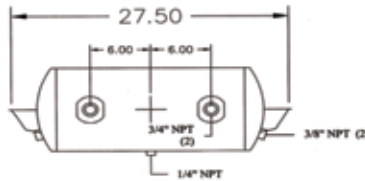

Sloan No.	Mtg. Hole Centers	Main Port (A)	Drain Port (B)	End Port (C)
461002	27.5"	3/4"	1/4"	3/8"

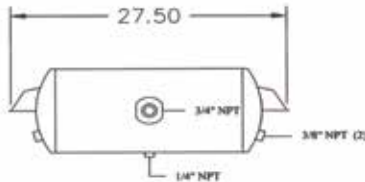

Sloan No.	Mtg. Hole Centers	Main Port (A)	Drain Port (B)	End Port (C)
461004	27.5"	3/4"	1/4"	3/8"

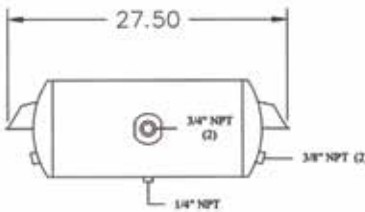

Sloan No.	Mtg. Hole Centers	Main Port *(A)	Drain Port (B)	End Port (C)
*461012*	27.5"	3/4"	1/4"	3/8"

\*Additional 3/4 main port (A) opposite of port shown.  
•Item is available as 22 pieces on a skid. Order part number with suffix -22.

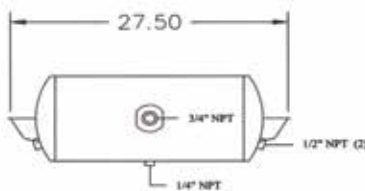

Sloan No.	Mtg. Hole Centers	Main Port (A)	Drain Port (B)	End Port (C)
461018	27.5"	3/4"	1/4"	1/2"

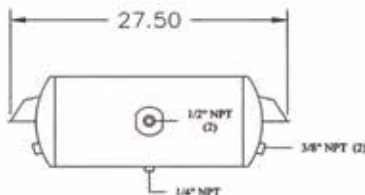

Sloan No.	Mtg. Hole Centers	Main Port (A)	Drain Port (B)	End Port (C)
*461019	27.5"	1/2"	1/4"	3/8"

\*Additional 1/2" port (A) opposite of port shown.

# Air Tanks

9.5" dia. Air Tanks - Continued  
1488 cubic inch capacity (6.44 Gallons)

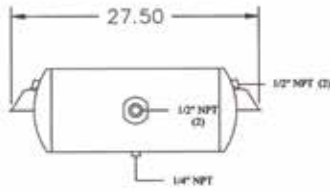

Sloan No.	Length	Main Port (A)	Drain Port (B)	End Port (C)
*461025	27.5"	1/2"	1/4"	1/2"

\*Additional 1/2" port (A) opposite of port shown.

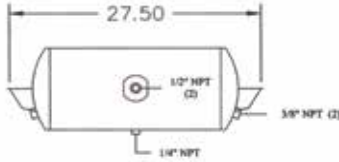

Sloan No.	Mtg. Hole Centers	Main Port (A)	Drain Port (B)	End Port (C)
461029	27.5"	1/2"	1/4"	3/8"

\*Additional 1/2" port (A) opposite of port shown.

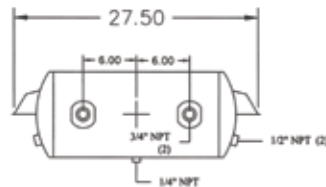

Sloan No.	Mtg. Hole Centers	Main Port (A)	Drain Port (B)	End Port (C)
461032	27.5"	3/4" (2)	1/4"	1/2"

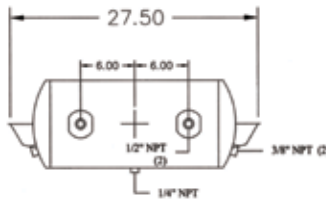

Sloan No.	Length	Main Port (A)	Drain Port (B)	End Port (C)
461033	27.5"	1/2" (2)	1/4"	3/8"

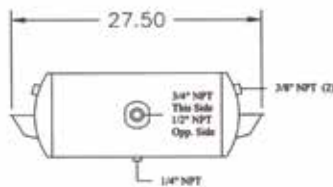

Sloan No.	Mtg. Hole Centers	Main Port (A)	Drain Port (B)	End Port (C)
*461034	27.5"	3/4"	1/4"	3/8"

\*Additional 1/2" port (A) opposite of port shown.

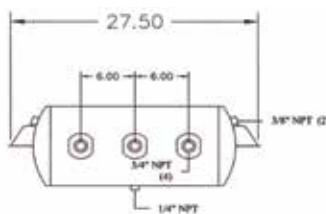

Sloan No.	Mtg. Hole Centers	Main Port (A)	Drain Port (B)	End Port (C)
461037	27.5"	3/4" (3)	1/4"	3/8"

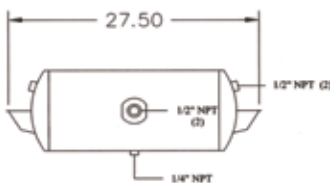

Sloan No.	Mtg. Hole Centers	Main Port (A)	Drain Port (B)	End Port (C)
461040	27.5"	1/2"	1/4"	1/2"

\*Additional 1/2" port (A) opposite of port shown.

- Tramec
- Rubber Hose Assemblies
- Coiled Air Assemblies
- 3-in-1 & 4-in-1 Wraps
- Bulk Hose
- Air Compressor Discharge Hose Assemblies
- Quick Fix™
- Air Hose Accessories
- Hose Clamps
- Gladhands & Accessories
- Air Tanks**
- Drain Valves
- Ground Plugs
- Truck Valves
- Selector Valves
- Brass Fittings
- Hose & Tube Chart
- Dash Control Valves
- Air Brake Valves
- Air Accessory Valves
- Air Cylinders
- Switches & Toggles
- Plugs, Sockets & Cables
- RV Plugs & Sockets
- Wire & Cable
- Electrical Harnesses
- Electrical Connectors
- Fuel Caps
- Oil Caps & Dipsticks
- Grease Fittings
- Water Pumps
- Wiper Blades
- Engine Heaters
- Link Cat's Eye®
- Hub Caps, Axilok® & Securex®
- Flitz
- MAXXGreen

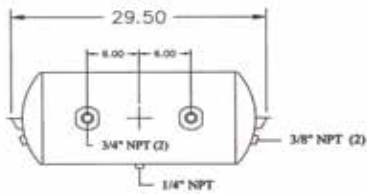

12" dia. Air Tanks  
2850 cubic inch capacity (12.34 Gallons)

Sloan No.	Mtg. Hole Centers	Main Port (A)	Drain Port (B)	End Port (C)
461008	29.5"	3/4"	1/4"	3/8"

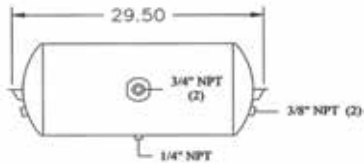

Sloan No.	Mtg. Hole Centers	Main Port (A)	Drain Port (B)	End Port (C)
*461009*	29.5"	3/4"	1/4"	3/8"
461010	29.5"	3/4"	1/4"	3/8"

\*Additional 3/4" main port (A) opposite of port shown.  
• Item is available as 18 pieces on a skid. Order part number with suffix -18.

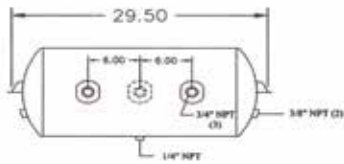

Sloan No.	Mtg. Hole Centers	Main Port (A)	Drain Port (B)	End Port (C)
*461022	29.5"	3/4" (3)	1/4"	3/8"

\*Additional 3/4" main port (A) opposite of port shown.

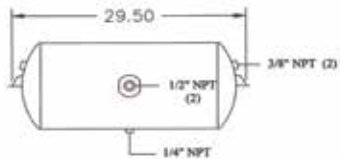

Sloan No.	Mtg. Hole Centers	Main Port (A)	Drain Port (B)	End Port (C)
*461024	29.5"	1/2"	1/4"	3/8"

\* Additional 1/2" main port (A) opposite of port shown.

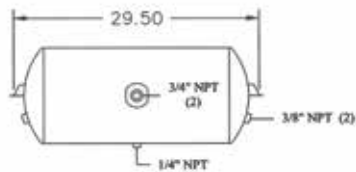

Sloan No.	Mtg. Hole Centers	Main Port (A)	Drain Port (B)	End Port (C)
*461035	29.5"	3/4"	1/4"	3/8"

\* Additional 1/2" main port (A) opposite of port shown.

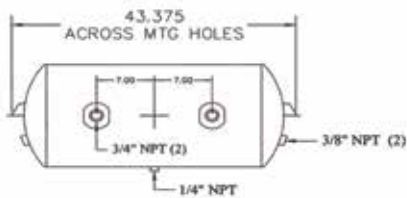

12" dia. Air Tanks -  
4400 cubic inch capacity (19.05 Gallons)

Sloan No.	Mtg. Hole Centers	Main Port (A)	Drain Port (B)	End Port (C)
461039	43.375"	3/4" (2)	1/4"	3/8"

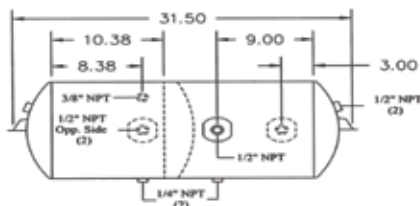

Sloan No.	Mtg. Hole Centers	Main Port (A)	Drain Port (B)	End Port (C)
461036	31.50"	1/2" (2)	1/4"	1/2"

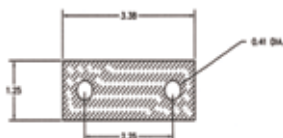

Rubber Mounting Pad

Sloan No.	Air Tank Usage
461011	All Bracket Mounted Tanks

# Drain Valves

## Drain Valves

- Cable or ring operates drain valve from any direction.
- Low profile drain valve design reduces chance of breakage.
- Automatically closes upon release of cable or ring.



Sloan No.	Description
401045	1/4" NPTF valve w/48" cable
401046	1/4" NPTF valve w/60" cable
401047	1/4" NPTF valve w/62" open end cable w/crimp
401070	1/4" NPTF valve only
401075	1/4" NPTF valve w/ (1) ring only
401729	cable only (sold by the ft.)
401730	crimp sleeve

## Low Profile Drain Valve



Sloan No.	Description
401086	1/4" NPTF valve w/60" closed end cable
401094	1/4" NPTF valve w/60" open end cable
401095	1/4" NPTF valve w/48" closed end cable

## Air Tank Safety Valve

- Prohibits system pressure from exceeding 150 psi.
- Won't bind in any position.
- Rate of flow 12 cfm at 150 psi.



Sloan No.	Thread Type
401004	1/4-18 NPTF
401005	3/8-18 NPTF
401315	M-22 Thread

## Drain Cocks

- Withstands up to 150 psi working pressure.
- Constructed of durable brass.



**Male Pipe Drain Cock**  
(internal seat)

Sloan No.	Pipe Thread	Length Closed	C Hex
SDC603-4	1/4	1.30	9/16



**Male Pipe Drain Cock**  
(external seat)

Sloan No.	Pipe Thread	L	C Hex
SDC604-2	1/8	.90	7/16
SDC604-4	1/4	1.00	9/16
SDC604-6	3/8	1.25	11/16

- Tramec**
- Rubber Hose Assemblies**
- Coiled Air Assemblies**
- 3-in-1 & 4-in-1 Wraps**
- Bulk Hose**
- Air Compressor Discharge Hose Assemblies**
- Quick Fix™**
- Air Hose Accessories**
- Hose Clamps**
- Gladhands & Accessories**
- Air Tanks**
- Drain Valves**
- Ground Plugs**
- Truck Valves**
- Selector Valves**
- Brass Fittings**
- Hose & Tube Chart**
- Dash Control Valves**
- Air Brake Valves**
- Air Accessory Valves**
- Air Cylinders**
- Switches & Toggles**
- Plugs, Sockets & Cables**
- RV Plugs & Sockets**
- Wire & Cable**
- Electrical Harnesses**
- Electrical Connectors**
- Fuel Caps**
- Oil Caps & Dipsticks**
- Grease Fittings**
- Water Pumps**
- Wiper Blades**
- Engine Heaters**
- Link Cat's Eye®**
- Hub Caps, Axilok® & Securex®**
- Flitz**
- MAXXGreen**



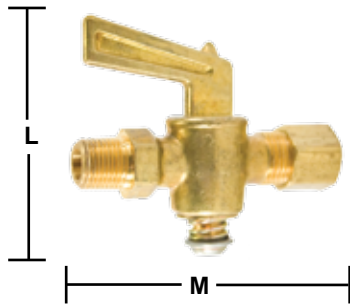

### Ground Plug Valve Compression to Male Pipe

Part Number	Tube Size	Pipe Thread	Straight Thread	L	M
SVC206-4-2	1/4	1/8	7/16-24	1.90	2.00
SVC206-4-4	1/4	1/4	7/16-24	1.90	1.90
SVC206-6-4	3/8	1/4	9/16-24	2.30	2.00



### Ground Plug Valve Male Pipe to Male Pipe

Part Number	Pipe Thread	L	M
SV401-2	1/8	1.90	1.85
SV401-4	1/4	1.90	1.85
SV401-6	3/8	2.38	2.25

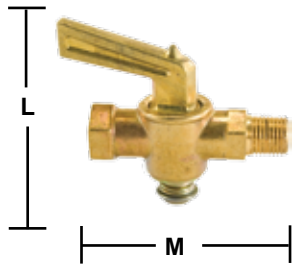

### Ground Plug Valve Female Pipe to Male Pipe

Part Number	Pipe Thread	L	M
SV402-2	1/8	1.90	1.85
SV402-4	1/4	1.90	1.85
SV402-6	3/8	2.38	2.25

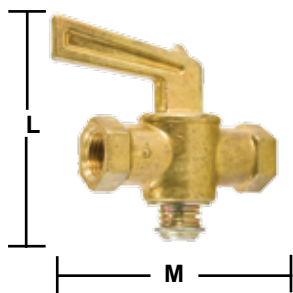

### Ground Plug Valve Female Pipe to Female Pipe

Part Number	Pipe Thread	L	M
SFF209-2	1/8	1.90	1.50
SFF209-4	1/4	1.90	1.65
SFF209-6	3/8	2.30	2.00
SFF209-8	1/2	2.30	2.40

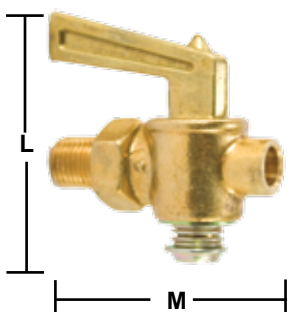

### Ground Plug Valve Male Pipe

Part Number	Pipe Thread	L	M
SV601-2	1/8	1.90	1.40
SV601-4	1/4	1.90	1.50
SV601-6	3/8	2.30	1.75
SV601-8	1/2	2.30	1.90

# Truck Valves

## Female Pipe to Male Pipe



Sloan No.	Pipe Thread
SV405P-6-6	3/8
SV405P-8-8	1/2

## Female Pipe to Male Pipe (pin handle)



Sloan No.	Pipe Thread	Hose Size
SV590PH-6	3/8	3/8
SV590PH-8	1/2	1/2

## Hose to Male Pipe



Sloan No.	Hose Size	Pipe Thread
SV404P-6-6	3/8	3/8
SV404P-10-6	5/8	3/8
SV404P-10-8	5/8	1/2
SV404P-12-6	3/4	3/8
SV404P-12-8	3/4	1/2

## Hose to Male Pipe (pin handle)



Sloan No.	Hose Size	Pipe Thread
SV404PH-6-6*	3/8	3/8
SV404PH-10-6	5/8	3/8

\*Barbed hose end

## Oil Tank Valve 45°



Sloan No.	Tube Size	Pipe Thread	Straight Thread
SOVF45-6-8	3/8	1/2	1/2-20
SOVF45-6-12	3/8	3/4	1/2-20

- Tramec
- Rubber Hose Assemblies
- Coiled Air Assemblies
- 3-in-1 & 4-in-1 Wraps
- Bulk Hose
- Air Compressor Discharge Hose Assemblies
- Quick Fix™
- Air Hose Accessories
- Hose Clamps
- Gladhands & Accessories
- Air Tanks
- Drain Valves
- Ground Plugs
- Truck Valves
- Selector Valves
- Brass Fittings
- Hose & Tube Chart
- Dash Control Valves
- Air Brake Valves
- Air Accessory Valves
- Air Cylinders
- Switches & Toggles
- Plugs, Sockets & Cables
- RV Plugs & Sockets
- Wire & Cable
- Electrical Harnesses
- Electrical Connectors
- Fuel Caps
- Oil Caps & Dipsticks
- Grease Fittings
- Water Pumps
- Wiper Blades
- Engine Heaters
- Link Cat's Eye®
- Hub Caps, Axilok® & Securex®
- Flitz
- MAXXGreen

## Selector Valves

- Maximum operating pressure 30 psi.
- Panel or bracket mounting.
- Operating temperature of -40°F to +180°F.
- Available "click" mechanism assures proper porting selection by sound and feel.
- Recommended for operation in diesel, gasoline, oil, water, air and detergent systems.

### 3-Way Selector

Sloan No.	Style	Pipe Thread	*Stem Length
SV406P-4	w/o click	1/4	1-3/8
SVC406P-4	w/ click	1/4	1-3/8
SV406P-6	w/o click	3/8	1-3/8
SVC406P-6	w/ click	3/8	1-3/8

\* Measured from top of bracket to underside of handle.



### 4-Way Selector

Sloan No.	Style	Pipe Thread	*Stem Length
SV407P-4	w/o click	1/4	1-3/8
SVC407P-4	w/ click	1/4	1-3/8
SV407P-6	w/o click	3/8	1-3/8
SVC407P-6	w/ click	3/8	1-3/8

\* Measured from top of bracket to underside of handle.



### Ball Valves

- Double o-ring seal.
- Forged brass body.
- Chrome plated brass ball.
- Superior performance in a variety of applications.

Sloan No.	Pipe Thread
SV500P-4	1/4
SV500P-6	3/8
SV500P-8	1/2



# Brass Fittings

We take pride with the high quality of our brass fittings. We use the highest quality material and specifications with your safety in mind. Building off of the reputation of CMI Fittings, we do our best to make as many fittings in our Galion, Ohio facility that we can. Simply put, **AMERICAN QUALITY MADE TO LAST**. Featured in this section of the catalog you will find the many types, shapes and sizes of brass and composite fittings.

- Quick Connect Brass
- Quick Connect Composite Fittings
- Rubber Hose Reusable Fittings
- Nylon Fittings
- Compression Fittings
- Transmission Shift Fittings
- Pipe Fittings
- Hose Barb Fittings
- Push-On Fittings
- Inverted Flare Fittings
- 45° Flare Fittings
- Copper Fittings
- Terminal Bolts



<b>Tramec</b>
<b>Rubber Hose Assemblies</b>
<b>Coiled Air Assemblies</b>
<b>3-in-1 &amp; 4-in-1 Wraps</b>
<b>Bulk Hose</b>
<b>Air Compressor Discharge Hose Assemblies</b>
<b>Quick Fix™</b>
<b>Air Hose Accessories</b>
<b>Hose Clamps</b>
<b>Gladhands &amp; Accessories</b>
<b>Air Tanks</b>
<b>Drain Valves</b>
<b>Ground Plugs</b>
<b>Truck Valves</b>
<b>Selector Valves</b>
<b>Brass Fittings</b>
<b>Hose &amp; Tube Chart</b>
<b>Dash Control Valves</b>
<b>Air Brake Valves</b>
<b>Air Accessory Valves</b>
<b>Air Cylinders</b>
<b>Switches &amp; Toggles</b>
<b>Plugs, Sockets &amp; Cables</b>
<b>RV Plugs &amp; Sockets</b>
<b>Wire &amp; Cable</b>
<b>Electrical Harnesses</b>
<b>Electrical Connectors</b>
<b>Fuel Caps</b>
<b>Oil Caps &amp; Dipsticks</b>
<b>Grease Fittings</b>
<b>Water Pumps</b>
<b>Wiper Blades</b>
<b>Engine Heaters</b>
<b>Link Cat's Eye®</b>
<b>Hub Caps, Axilok® &amp; Securex®</b>
<b>Flitz</b>
<b>MAXXGreen</b>

## 45° Push To Connect Fitting



Sloan No.	Tube Size	Thread Size
*S254PMT-4-2	1/4"	1/8"
*S254PMT-4-4	1/4"	1/4"
*S254PMT-4-6	1/4"	3/8"
*S254PMT-6-4	3/8"	1/4"
*S254PMT-6-6	3/8"	3/8"
*S254PMT-8-6	1/2"	3/8"
*S254PMT-8-8	1/2"	1/2"
*S254PMT-12-8	3/4"	1/2"

\*Marked D.O.T.

## Straight Union



Sloan No.	Tube Size
*S62PMT-4	1/4
*S62PMT-6	3/8
*S62PMT-8	1/2
*S62PMT-10	5/8
*S62PMT-12	3/4

\*Marked D.O.T.

## Bulkhead Union



Sloan No.	Tube Size
*S62PMTBH-4	1/4
*S62PMTBH-6	3/8
*S62PMTBH-8	1/2

\*Marked D.O.T.

## Union Tee



Sloan No.	Tube Size
*S264PMT-4	1/4
*S264PMT-6	3/8
*S264PMT-8	1/2

\*Marked D.O.T.

## Union Elbow



Sloan No.	Tube Size
*S265PMT-4	1/4
*S265PMT-6	3/8
*S265PMT-8	1/2

\*Marked D.O.T.

## Female Connector



Sloan No.	Tube Size	Thread Size
*S66PMT-4-2	1/4	1/8
*S66PMT-4-4	1/4	1/4
*S66PMT-6-4	3/8	1/4
*S66PMT-6-6	3/8	3/8

\*Marked D.O.T.

## Male Connector



Sloan No.	Tube Size	Thread Size
*S68PMT-4-2	1/4	1/8
*S68PMT-4-4	1/4	1/4
*S68PMT-4-6	1/4	3/8
*S68PMT-6-2	3/8	1/8
*S68PMT-6-4	3/8	1/4
*S68PMT-6-6	3/8	3/8
*S68PMT-6-8	3/8	1/2
*S68PMT-8-4	1/2	1/4
*S68PMT-8-6	1/2	3/8
*S68PMT-8-8	1/2	1/2

\*Marked D.O.T.

## 360° Male Swivel Elbow

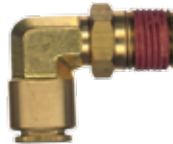

Sloan No.	Tube Size	Thread Size
*S269PMT-4-2	1/4	1/8
*S269PMT-4-4	1/4	1/4
*S269PMT-4-6	1/4	3/8
*S269PMT-6-2	3/8	1/8
*S269PMT-6-4	3/8	1/4
*S269PMT-6-6	3/8	3/8
*S269PMT-6-8	3/8	1/2
*S269PMT-8-4	1/2	1/4
*S269PMT-8-6	1/2	3/8
*S269PMT-8-8	1/2	1/2
*S269PMT-12-8	3/4	1/2
*S269PMT-12-12	3/4	3/4

\*Marked D.O.T.

## Male Elbow (Non-Swivel)

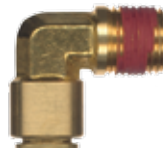

Sloan No.	Tube Size	Thread Size
*S269PMTNS-4-2	1/4	1/8
*S269PMTNS-4-4	1/4	1/4
*S269PMTNS-6-4	3/8	1/4
*S269PMTNS-6-6	3/8	3/8
*S269PMTNS-8-6	1/2	3/8
*S269PMTNS-8-8	1/2	1/2

\*Marked D.O.T.

# Quick Connect Brass



## Female Elbow



Sloan No.	Tube Size	Thread Size
*S270PMTNS-4-2	1/4	1/8
*S270PMTNS-4-4	1/4	1/4
*S270PMTNS-6-4	3/8	1/4

\*Marked D.O.T.

## Male Swivel Branch Tee



Sloan No.	Tube Size	Thread Size
*S272PMT-4-2	1/4	1/8
*S272PMT-4-4	1/4	1/4
*S272PMT-6-4	3/8	1/4
*S272PMT-6-6	3/8	3/8
*S272PMT-8-4	1/2	1/4
*S272PMT-8-6	1/2	3/8
*S272PMT-8-8	1/2	1/2

\*Marked D.O.T.

## Male Swivel Run Tee



Sloan No.	Tube Size	Thread Size
*S271PMT-4-2	1/4	1/8
*S271PMT-4-4	1/4	1/4
*S271PMT-6-4	3/8	1/4
*S271PMT-6-6	3/8	3/8
*S271PMT-8-6	1/2	3/8
*S271PMT-8-8	1/2	1/2

\*Marked D.O.T.

## Plug



Sloan No.	Tube O.D.
*S639PMT-4	1/4
*S639PMT-6	3/8
*S639PMT-8	1/2

\*Marked D.O.T.

## Standpipes

Sloan No.	Description	Tube Size 1	Tube Size 2	Tube Size 3
371SP-4-4	Plug In Run Tee	1/4" O.D.	1/4" O.D.	1/4"
371SP-4-6	Plug In Run Tee	1/4" O.D.	1/4" O.D.	3/8"
371SP-6-4-6	Plug In Run Tee	3/8" O.D.	1/4" O.D.	3/8"
371SP-6-6	Plug In Run Tee	3/8" O.D.	3/8" O.D.	3/8"
371SP-8-4-8	Plug In Run Tee	1/2" O.D.	1/4" O.D.	1/2"

- No tools required for assembly/disassembly
- Meets DOT/SAE performance requirements
- Flexible alternative for tight routing configurations
- Common applications - suspension bags, gauges, behind the dash, and under the seat



Sloan No.	Description	Tube Size 1	Tube Size 2
369SP-4-4	Standpipe Elbow	1/4" O.D.	1/4"
369SP-4-6	Standpipe Elbow	1/4" O.D.	3/8"
369SP-6-4	Standpipe Elbow	3/8" O.D.	1/4"
369SP-6-6	Standpipe Elbow	3/8" O.D.	3/8"
369SP-6-8	Standpipe Elbow	3/8" O.D.	1/2"
369SP-8-8	Standpipe Elbow	1/2" O.D.	1/2"



Sloan No.	Description	Tube Size 1	Tube Size 2
37SP-4-6	Reducer Adapter	1/4" O.D.	3/8"
37SP-6-4	Reducer Adapter	3/8" O.D.	1/4"



- Tramec
- Rubber Hose Assemblies
- Coiled Air Assemblies
- 3-in-1 & 4-in-1 Wraps
- Bulk Hose
- Air Compressor Discharge Hose Assemblies
- Quick Fix™
- Air Hose Accessories
- Hose Clamps
- Gladhands & Accessories
- Air Tanks
- Drain Valves
- Ground Plugs
- Truck Valves
- Selector Valves
- Brass Fittings
- Hose & Tube Chart
- Dash Control Valves
- Air Brake Valves
- Air Accessory Valves
- Air Cylinders
- Switches & Toggles
- Plugs, Sockets & Cables
- RV Plugs & Sockets
- Wire & Cable
- Electrical Harnesses
- Electrical Connectors
- Fuel Caps
- Oil Caps & Dipsticks
- Grease Fittings
- Water Pumps
- Wiper Blades
- Engine Heaters
- Link Cat's Eye®
- Hub Caps, Axilok® & Securex®
- Flitz
- MAXXGreen

## Male Swivel Elbow 45 Degree



Sloan No.	Tube Size	Pipe Thread
*S754PMT-4-2	1/4	1/8
*S754PMT-4-4	1/4	1/4
*S754PMT-4-6	1/4	3/8
*S754PMT-6-4	3/8	1/4
*S754PMT-6-6	3/8	3/8

\*Marked D.O.T.  
Thread sealant applied

## Male Connector



Sloan No.	Tube Size	Pipe Thread
S768PMT-2-1	1/8	1/16
S768PMT-2-2	1/8	1/8
S768PMT-2-4	1/8	1/4
*S768PMT-4-2	1/4	1/8
*S768PMT-4-4	1/4	1/4
*S768PMT-4-6	1/4	3/8
*S768PMT-6-2	3/8	1/8
*S768PMT-6-4	3/8	1/4
*S768PMT-6-6	3/8	3/8
*S768PMT-6-8	3/8	1/2
*S768PMT-8-4	1/2	1/4
*S768PMT-8-6	1/2	3/8
*S768PMT-8-8	1/2	1/2

\*Marked D.O.T.  
Thread sealant applied

## Union Straight



Sloan No.	Tube Size
S762PMT-2	1/8
*S762PMT-532	5/32
S762PMT-3	3/16
*S762PMT-4	1/4
*S762PMT-6	3/8
*S762PMT-8	1/2

\*Marked D.O.T.

## Male Swivel Elbow



Sloan No.	Tube Size	Pipe Thread
S769PMT-2-2	1/8	1/8
S769PMT-2-4	1/8	1/4
*S769PMT-4-2	1/4	1/8
*S769PMT-4-4	1/4	1/4
*S769PMT-4-6	1/4	3/8
*S769PMT-6-2	3/8	1/8
*S769PMT-6-4	3/8	1/4
*S769PMT-6-6	3/8	3/8
*S769PMT-6-8	3/8	1/2
*S769PMT-8-4	1/2	1/4
*S769PMT-8-6	1/2	3/8
*S769PMT-8-8	1/2	1/2

\*Marked D.O.T.  
Thread sealant applied

## Bulkhead Union



Sloan No.	Tube Size
S762PMTBH-2	1/8
*S762PMTBH-4	1/4
*S762PMTBH-6	3/8
*S762PMTBH-8	1/2

\*Marked D.O.T.

## Union Tee



Sloan No.	Tube Size
S764PMT-2	1/8
*S764PMT-532	5/32
S764PMT-3	3/16
*S764PMT-4	1/4
*S764PMT-6	3/8
*S764PMT-8	1/2

\*Marked D.O.T.

## Male Branch Swivel Tee



Sloan No.	Tube Size	Pipe Thread
S772PMT-2-2	1/8	1/8
S772PMT-2-4	1/8	1/4
*S772PMT-4-2	1/4	1/8
*S772PMT-4-4	1/4	1/4
*S772PMT-6-4	3/8	1/4
*S772PMT-6-6	3/8	3/8
*S772PMT-8-6	1/2	3/8

\*Marked D.O.T.  
Thread sealant applied

# Rubber Hose (Reusable Fittings)



## Hose Sleeve



Sloan No.	Hose Size
S360AB-6	3/8
S360AB-8	1/2

## Union Body



Sloan No.	Hose Size
B362RB-6	3/8
B362RB-8	1/2

## Hose Nut



Sloan No.	Hose Size
S361AB-6	3/8
S361AB-8	1/2

## Female Swivel Connector w/Adapter



Sloan No.	Hose Size	Thread ABS	Size Pipe
S363RB-6	3/8	3/8	3/8
S363RB-8	1/2	1/2	3/8
*S363RB-6S	3/8	3/8	3/8
*S363RB-8S	1/2	1/2	3/8

\*Fitting comes with a spring guard.

## Nut Less Spring Guard



Sloan No.	Hose Size
S361ABS-6	3/8
S361ABS-8	1/2

For use with S371AS Spring Guard.

## Female Swivel Connector



Sloan No.	Hose Size
S366RBSV-634	3/8
S366RBSV-878	1/2

## Union



Sloan No.	Hose Size
S362RB-6	3/8
S362RB-8	1/2

## Female Swivel Connector Body



Sloan No.	Hose Size	Pipe Thread
B366RBSV-634	3/8	3/4
B366RBSV-878	1/2	7/8

Tramec
Rubber Hose Assemblies
Coiled Air Assemblies
3-in-1 & 4-in-1 Wraps
Bulk Hose
Air Compressor Discharge Hose Assemblies
Quick Fix™
Air Hose Accessories
Hose Clamps
Gladhands & Accessories
Air Tanks
Drain Valves
Ground Plugs
Truck Valves
Selector Valves
Brass Fittings
Hose & Tube Chart
Dash Control Valves
Air Brake Valves
Air Accessory Valves
Air Cylinders
Switches & Toggles
Plugs, Sockets & Cables
RV Plugs & Sockets
Wire & Cable
Electrical Harnesses
Electrical Connectors
Fuel Caps
Oil Caps & Dipsticks
Grease Fittings
Water Pumps
Wiper Blades
Engine Heaters
Link Cat's Eye®
Hub Caps, Axilok® & Securex®
Flitz
MAXXGreen



# Rubber Hose (Reusable Fittings)

## Spring Guard



Sloan No.	Hose Size
S371AS-6	3/8
S371AS-8	1/2

For use with S361ABS Nut.

## Male Connector



Sloan No.	Hose Size	Pipe Thread
S368AB-6-4	3/8	1/4
S368AB-6-6	3/8	3/8
S368AB-6-8	3/8	1/2
S368AB-8-6	1/2	3/8
S368AB-8-8	1/2	1/2

## Adapter



Sloan No.	Pipe Size	Straight Thread
S376AB-3/4-4	1/4	3/4-20
S376AB-3/4-6	3/8	3/4-20
S376AB-7/8-6	3/8	7/8-20
S376AB-7/8-8	1/2	7/8-20
S376AB-3/4-8	1/2	3/4-20

## Male Connector Body



Sloan No.	Hose Size	Pipe Thread
S368AB-6-4-1	3/8	1/4
S368AB-6-6-1	3/8	3/8
S368AB-6-8-1	3/8	1/2
S368AB-8-6-1	1/2	3/8
S368AB-8-8-1	1/2	1/2

## Male Connector w/Spring Guard



Sloan No.	Hose Size	Pipe Thread
S378AB-6-4	3/8	1/4
S378AB-6-6	3/8	3/8
S378AB-6-8	3/8	1/2
S378AB-8-6	1/2	3/8
S378AB-8-8	1/2	1/2

## Nut w/Spring Guard



Sloan No.	Hose Size
S371ABS-6	3/8
S371ABS-8	1/2

# Nylon Fittings

## Nylon Tube Sleeve



Sloan No.	Tube Size
S760AB-4	1/4
S760AB-6	3/8
S760AB-8	1/2
S760AB-10	5/8
S760AB-12	3/4

Ref. SAE 100115

## Union Tee



Sloan No.	Tube Size
S764AB-4	1/4
S764AB-6	3/8
S764AB-8	1/2
S764AB-10	5/8

Ref. SAE 100401BA

## Union Elbow

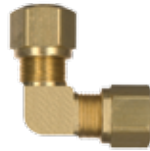

Sloan No.	Tube Size
S765AB-4	1/4
S765AB-6	3/8
S765AB-8	1/2
S765AB-10	5/8

Ref. SAE 100201BA

## Nylon Tube Nut



Sloan No.	Tube Size
S761AB-4	1/4
S761AB-6	3/8
S761AB-8	1/2
S761AB-10	5/8
S761AB-12	3/4

Ref. SAE 100110

## Female Connector



Sloan No.	Tube Size	Pipe Thread
S766AB-4-2	1/4	1/8
S766AB-4-4	1/4	1/4
S766AB-6-2	3/8	1/8
S766AB-6-4	3/8	1/4
S766AB-6-6	3/8	3/8
S766AB-8-6	1/2	3/8
S766AB-8-8	1/2	1/2
S766AB-10-6	5/8	3/8
S766AB-10-8	5/8	1/2

Ref. SAE 100103 BA

## Union



Sloan No.	Tube Size
S762AB-4	1/4
S762AB-6	3/8
S762AB-8	1/2
S762AB-10	5/8
S762AB-12	3/4

Ref. SAE 100101BA

## Male Connector



Sloan No.	Tube Size	Pipe Thread
S768AB-4-2	1/4	1/8
S768AB-4-4	1/4	1/4
S768AB-4-6	1/4	3/8
S768AB-6-2	3/8	1/8
S768AB-6-4	3/8	1/4
S768AB-6-6	3/8	3/8
S768AB-6-8	3/8	1/2
S768AB-8-4	1/2	1/4
S768AB-8-6	1/2	3/8
S768AB-8-8	1/2	1/2
S768AB-8-12	1/2	3/4
S768AB-10-6	5/8	3/8
S768AB-10-8	5/8	1/2
*S768AB-10-12	5/8	3/4
S768AB-12-8	3/4	1/2
S768AB-12-12	3/4	3/4

Ref. SAE 100102 BA (\* Non SAE)

## Tube Insert Stainless Steel



Sloan No.	Tube Size
S763AB-4	1/4
S763AB-6	3/8
S763AB-8	1/2
S763AB-10	5/8
S763AB-12	3/4

- Tramec
- Rubber Hose Assemblies
- Coiled Air Assemblies
- 3-in-1 & 4-in-1 Wraps
- Bulk Hose
- Air Compressor Discharge Hose Assemblies
- Quick Fix™
- Air Hose Accessories
- Hose Clamps
- Gladhands & Accessories
- Air Tanks
- Drain Valves
- Ground Plugs
- Truck Valves
- Selector Valves
- Brass Fittings
- Hose & Tube Chart
- Dash Control Valves
- Air Brake Valves
- Air Accessory Valves
- Air Cylinders
- Switches & Toggles
- Plugs, Sockets & Cables
- RV Plugs & Sockets
- Wire & Cable
- Electrical Harnesses
- Electrical Connectors
- Fuel Caps
- Oil Caps & Dipsticks
- Grease Fittings
- Water Pumps
- Wiper Blades
- Engine Heaters
- Link Cat's Eye®
- Hub Caps, Axilok® & Securex®
- Flitz
- MAXXGreen

## Male Elbow



Sloan No.	Tube Size	Pipe Thread
S769AB-4-2	1/4	1/8
S769AB-4-4	1/4	1/4
S769AB-4-6	1/4	3/8
S769AB-6-2	3/8	1/8
S769AB-6-4	3/8	1/4
S769AB-6-6	3/8	3/8
S769AB-6-8	3/8	1/2
S769AB-8-4	1/2	1/4
S769AB-8-6	1/2	3/8
S769AB-8-8	1/2	1/2
S769AB-10-6	5/8	3/8
S769AB-10-8	5/8	1/2
S769AB-12-8	3/4	1/2
S769AB-12-12	3/4	3/4

Ref. SAE 100202 BA

## Female Elbow



Sloan No.	Tube Size	Pipe Thread
S770AB-4-2	1/4	1/8
S770AB-4-4	1/4	1/4
S770AB-6-4	3/8	1/4
S770AB-6-6	3/8	3/8
S770AB-8-6	1/2	3/8
S770AB-8-8	1/2	1/2
S770AB-10-8	5/8	1/2

Ref. SAE 100203 BA

## Male Run Tee



Sloan No.	Tube Size	Pipe Thread
S771AB-4-2	1/4	1/8
S771AB-4-4	1/4	1/4
S771AB-6-4	3/8	1/4
S771AB-6-6	3/8	3/8
S771AB-8-6	1/2	3/8
S771AB-8-8	1/2	1/2
S771AB-10-8	5/8	1/2

Ref. SAE 100424 BA

## Male Branch Tee



Sloan No.	Tube Size	Pipe Thread
S772AB-4-2	1/4	1/8
S772AB-4-4	1/4	1/4
S772AB-6-2	3/8	1/8
S772AB-6-4	3/8	1/4
S772AB-6-6	3/8	3/8
S772AB-8-4	1/2	1/4
S772AB-8-6	1/2	3/8
S772AB-8-8	1/2	1/2
S772AB-10-8	5/8	1/2

## Bulkhead Union



Sloan No.	Tube Size
S774AB-4	1/4
S774AB-6	3/8
S774AB-8	1/2

## 45° Elbow



Sloan No.	Tube Size	Pipe Thread
S779AB-4-2	1/4	1/8
S779AB-4-4	1/4	1/4
S779AB-6-2	3/8	1/8
S779AB-6-4	3/8	1/4
S779AB-6-6	3/8	3/8
S779AB-6-8	3/8	1/2
S779AB-8-4	1/2	1/4
S779AB-8-6	1/2	3/8
S779AB-8-8	1/2	1/2
S779AB-10-6	5/8	3/8
S779AB-10-8	5/8	1/2

Ref. SAE 100302 BA

\* All nylon male thread fittings are shipped with pre-applied thread sealant.

# Compression Fittings



## Compression Tee w/ Female Pipe Thread on Branch



Sloan No.	Tube Size	Pipe Thread
SCT1-6-2	3/8	1/8

## Compression Cap



Sloan No.	Tube Size	Straight Thread
S61CP-4	1/4	7/16-24
S61CP-6	3/8	9/16-24
S61CP-8	1/2	11/16-20
S61CP-10	5/8	13/16-18

## Compression Sleeve



Sloan No.	Tube Size
S60-2	1/8
S60-3	3/16
S60-4	1/4
S60-5	5/16
S60-6	3/8
S60-7	7/16
S60-8*	1/2
S60-10*	5/8
S60-12	3/4
S60-14	7/8

Ref. SAE 060115 (\*Non SAE)

## Compression Nut - Long



Sloan No.	Tube Size	Straight Thread
S61L-2*	1/8	5/16-24
S61L-4	1/4	7/16-24
S61L-5	5/16	1/2-24
S61L-6	3/8	9/16-24
S61L-8	1/2	11/16-20
S61L-10	5/8	13/16-18
S61L-12	3/4	1-18

Ref. SAE 060111 (\*Non SAE)

## Compression Sleeve



Sloan No.	Tube Size
S60PT-4	1/4
S60PT-5	5/16
S60PT-6	3/8
S60PT-8	1/2
S60PT-10	5/8

## Compression Union Tube Both Ends



Sloan No.	Tube Size	
	1	2
S62-2	1/8	1/8
S62-4-2	1/4	1/8
S62-4-3	1/4	3/16
S62-3	3/16	3/16
S62-4	1/4	1/4
S62-5-4	5/16	1/4
S62-5	5/16	5/16
S62-6-4	3/8	1/4
S62-6-5	3/8	5/16
S62-6	3/8	3/8
S62-7*	7/16	7/16
S62-8-6*	1/2	3/8
S62-8	1/2	1/2
S62-10-6*	5/8	3/8
S62-10-8*	5/8	1/2
S62-10*	5/8	5/8
S62-12	3/4	3/4
S62-14*	7/8	7/8

## Compression Nut



Sloan No.	Tube Size	Straight Thread
S61-2	1/8	5/16-24
S61-3	3/16	3/8-24
S61-4	1/4	7/16-24
S61-5	5/16	1/2-24
S61-6	3/8	9/16-24
S61-7*	7/16	5/8-24
S61-8*	1/2	11/16-20
S61-10*	5/8	13/16-18
S61-12	3/4	1-18
S61-14*	7/8	1-1/8-18

Ref. SAE 060110 (\*Non SAE)

- Tramec
- Rubber Hose Assemblies
- Coiled Air Assemblies
- 3-in-1 & 4-in-1 Wraps
- Bulk Hose
- Air Compressor Discharge Hose Assemblies
- Quick Fix™
- Air Hose Accessories
- Hose Clamps
- Gladhands & Accessories
- Air Tanks
- Drain Valves
- Ground Plugs
- Truck Valves
- Selector Valves
- Brass Fittings
- Hose & Tube Chart
- Dash Control Valves
- Air Brake Valves
- Air Accessory Valves
- Air Cylinders
- Switches & Toggles
- Plugs, Sockets & Cables
- RV Plugs & Sockets
- Wire & Cable
- Electrical Harnesses
- Electrical Connectors
- Fuel Caps
- Oil Caps & Dipsticks
- Grease Fittings
- Water Pumps
- Wiper Blades
- Engine Heaters
- Link Cat's Eye®
- Hub Caps, Axilok® & Securex®
- Flitz
- MAXXGreen

## Brass Compression Insert



Sloan No.	Tube Size
S63PT-4	1/4
S63PT-5	5/16
S63PT-6	3/8
S63PT-8	1/2
S63PT-10	5/8

## Compression x F.I.P. Union



Sloan No.	Tube Size	Pipe Thread
S66-2-2	1/8	1/8
S66-3-2	3/16	1/8
S66-3-4	3/16	1/4
S66-4-2	1/4	1/8
S66-4-4	1/4	1/4
S66-4-6	1/4	3/8
S66-4-8	1/4	1/2
S66-5-2	5/16	1/8
S66-5-4	5/16	1/4
S66-5-6	5/16	3/8
S66-6-2	3/8	1/8
S66-6-4	3/8	1/4
S66-6-6	3/8	3/8
S66-6-8	3/8	1/2
S66-8-4	1/2	1/4
S66-8-6	1/2	3/8
S66-8-8	1/2	1/2
S66-10-6	5/8	3/8
S66-10-8	5/8	1/2
S66-10-12	5/8	3/4
S66-12-8	3/4	1/2
S66-14-12	7/8	3/4

## Compression Tee Tube All Ends



Sloan No.	Tube Size	
	1	2
S64-2	1/8	1/8
S64-3	3/16	3/16
S64-4	1/4	1/4
S64-5	5/16	5/16
S64-6-6-4	3/8	1/4
S64-6	3/8	3/8
S64-8-8-6	1/2	3/8
S64-8	1/2	1/2
S64-10	5/8	5/8



## Compression x M.I.P. Union

## Compression Elbow Tube Both Ends



Sloan No.	Tube Size	
	1	2
S65-2	1/8	1/8
S65-3	3/16	3/16
S65-4	1/4	1/4
S65-5	5/16	5/16
S65-6	3/8	3/8
S65-7*	7/16	7/16
S65-8*	1/2	1/2
S65-10*	5/8	5/8
S65-12	3/4	3/4



Sloan No.	Tube Size	Pipe Thread
S68-2-2	1/8	1/8
S68-3-2	3/16	1/8
S68-3-4	3/16	1/4
S68-4-2	1/4	1/8
S68-4-4	1/4	1/4
S68-4-6	1/4	3/8
S68-4-8	1/4	1/2
S68-5-2	5/16	1/8
S68-5-4	5/16	1/4
S68-5-6	5/16	3/8
S68-6-2	3/8	1/8
S68-6-4	3/8	1/4
S68-6-6	3/8	3/8

Ref. SAE 060201 (\*Non SAE)

cont'd next page

# Compression Fittings

## Compression x M.I.P. Union (cont'd)



Sloan No.	Tube Size	Pipe Thread
S68-6-8	3/8	1/2
S68-6-12	3/8	3/4
S68-7-4	7/16	1/4
S68-7-6	7/16	3/8
S68-8-4	1/2	1/4
S68-8-6	1/2	3/8
S68-8-8	1/2	1/2
S68-8-12	1/2	3/4
S68-10-6	5/8	3/8
S68-10-8	5/8	1/2
S68-10-12	5/8	3/4
S68-12-8	3/4	1/2
S68-12-12	3/4	3/4
S68-14-8	7/8	1/2
S68-14-12	7/8	3/4

## Compression x F.I.P. Elbow



Sloan No.	Tube Size	Pipe Thread
S70-2-2	1/8	1/8
S70-3-2	3/16	1/8
S70-4-2	1/4	1/8
S70-4-4	1/4	1/4
S70-5-2	5/16	1/8
S70-5-4	5/16	1/4
S70-6-2	3/8	1/8
S70-6-4	3/8	1/4
S70-6-6	3/8	3/8
S70-6-8	3/8	1/2
S70-8-4	1/2	1/4
S70-8-6	1/2	3/8
S70-8-8	1/2	1/2
S70-10-8	5/8	1/2

## Compression Tee w/Male Pipe Thread on Run



Sloan No.	Tube Size	Pipe Thread
S71-2-2	1/8	1/8
S71-3-2	3/16	1/8
S71-4-2	1/4	1/8
S71-4-4	1/4	1/4
S71-5-2	5/16	1/8
S71-5-4	5/16	1/4
S71-6-2	3/8	1/8
S71-6-4	3/8	1/4
S71-6-6	3/8	3/8
S71-8-6	1/2	3/8
S71-8-8	1/2	1/2
S71-10-8	5/8	1/2

## Compression x M.I.P. Elbow



Sloan No.	Tube Size	Pipe Thread
S69-2-2	1/8	1/8
S69-3-2	3/16	1/8
S69-3-4	3/16	1/4
S69-4-2	1/4	1/8
S69-4-4	1/4	1/4
S69-4-6	1/4	3/8
S69-5-2	5/16	1/8
S69-5-4	5/16	1/4
S69-5-6	5/16	3/8
S69-5-8	5/16	1/2
S69-6-2	3/8	1/8
S69-6-4	3/8	1/4
S69-6-6	3/8	3/8
S69-6-8	3/8	1/2
S69-6-12	3/8	3/4
S69-7-4	7/16	1/4
S69-7-6	7/16	3/8
S69-8-4	1/2	1/4
S69-8-6	1/2	3/8
S69-8-8	1/2	1/2
S69-10-6	5/8	3/8
S69-10-8	5/8	1/2
S69-10-12	5/8	3/4

## Compression Tee w/Male Pipe Thread on Branch



Sloan No.	Tube Size	Pipe Thread
S72-2-2	1/8	1/8
S72-3-2	3/16	1/8
S72-4-2	1/4	1/8
S72-4-4	1/4	1/4
S72-5-2	5/16	1/8
S72-5-4	5/16	1/4
S72-6-2	3/8	1/8
S72-6-4	3/8	1/4
S72-6-6	3/8	3/8
S72-8-6	1/2	3/8
S72-8-8	1/2	1/2
S72-10-8	5/8	1/2

- Tramec
- Rubber Hose Assemblies
- Coiled Air Assemblies
- 3-in-1 & 4-in-1 Wraps
- Bulk Hose
- Air Compressor Discharge Hose Assemblies
- Quick Fix™
- Air Hose Accessories
- Hose Clamps
- Gladhands & Accessories
- Air Tanks
- Drain Valves
- Ground Plugs
- Truck Valves
- Selector Valves
- Brass Fittings
- Hose & Tube Chart
- Dash Control Valves
- Air Brake Valves
- Air Accessory Valves
- Air Cylinders
- Switches & Toggles
- Plugs, Sockets & Cables
- RV Plugs & Sockets
- Wire & Cable
- Electrical Harnesses
- Electrical Connectors
- Fuel Caps
- Oil Caps & Dipsticks
- Grease Fittings
- Water Pumps
- Wiper Blades
- Engine Heaters
- Link Cat's Eye®
- Hub Caps, Axilok® & Securex®
- Flitz
- MAXXGreen

## Sleeve



S60TF-3



S60TF-2 & S60TF-5/32

Sloan No.	Tube Size
S60TF-2	1/8
S60TF-5/32	5/32
S60TF-3	3/16

## Nut



Sloan No.	Tube Size
S61TF-2	1/8
S61TF-5/32	5/32
S61TF-3	3/16

## Union



Sloan No.	Tube Size
S62TF-2	1/8
S62TF-5/32	5/32

## Male Elbow



Sloan No.	Tube Size	Pipe Thread
S69TF-2-2	1/8	1/8
S69TF-5/32-2	5/32	1/8

## Male Connector



Sloan No.	Tube Size	Pipe Thread
S68TF-2-1	1/8	1/16
S68TF-2-2	1/8	1/8
S68TF-5/32-1	5/32	1/16
S68TF-5/32-2	5/32	1/8
S68TF-3-2	3/16	1/8

# Pipe Fittings

## Female Cross



Sloan No.	Pipe Thread
S102-2	1/8
S102-4	1/4
S102-6	3/8
S102-8	1/2

## Female Union



Sloan No.	Pipe Thread
S104-4	1/4
S104-6	3/8
S104-8	1/2

## Long Nipple



Sloan No.	Pipe No.	Thread
S113-02-1.5-R	1/8	1.5
S113-02-2-R	1/8	2.0
S113-02-2.5-R	1/8	2.5
S113-02-3-R	1/8	3.0
S113-04-1.5-R	1/4	1.5
S113-04-2-R	1/4	2.0
S113-04-2.5-R	1/4	2.5
S113-04-3-R	1/4	3.0
S113-06-1.5-R	3/8	1.5
S113-06-2-R	3/8	2.0
S113-06-2.5-R	3/8	2.5
S113-06-3-R	3/8	3.0
S113-08-2.5-R	1/2	2.5
S113-08-3-R	1/2	3.0
S113-12-2-R	3/4	2.0

## Reducer Coupling



Sloan No.	Pipe Thread 1	Pipe Thread 2
S119-4-2	1/4	1/8
S119-6-2	3/8	1/8
S119-6-4	3/8	1/4
S119-8-2	1/2	1/8
S119-8-4	1/2	1/4
S119-8-6	1/2	3/8

Ref. SAE 130138

## Adapter



Sloan No.	Pipe Thread	
	1	2
S120-2	1/8	1/8
S120-4-2	1/4	1/8
S120-4	1/4	1/4
S120-6-2	3/8	1/8
S120-6-4	3/8	1/4
S120-6	3/8	3/8
S120-8-4	1/2	1/4
S120-8-6	1/2	3/8
S120-8	1/2	1/2
S120-12-8	3/4	1/2

Ref. SAE 130139

## 90° Female Elbow



Sloan No.	Pipe Thread
S200-2	1/8
S200-4	1/4
S200-6	3/8
S200-8	1/2

Ref. SAE 130238

## 90° Street Elbow



Sloan No.	Pipe Thread	
	1	2
S202-2	1/8	1/8
S202-4-2	1/4	1/8
S202-4	1/4	1/4
S202-6	3/8	3/8
S202-8-6	1/2	3/8
S202-8	1/2	1/2
S202-12	3/4	3/4

Ref. SAE 130239 (\*Non SAE)

## Tee



Sloan No.	Pipe Thread
S203-2	1/8
S203-4	1/4
S203-6	3/8
S203-8	1/2

Ref. SAE 130438

<b>Tramec</b>
<b>Rubber Hose Assemblies</b>
<b>Coiled Air Assemblies</b>
<b>3-in-1 &amp; 4-in-1 Wraps</b>
<b>Bulk Hose</b>
<b>Air Compressor Discharge Hose Assemblies</b>
<b>Quick Fix™</b>
<b>Air Hose Accessories</b>
<b>Hose Clamps</b>
<b>Gladhands &amp; Accessories</b>
<b>Air Tanks</b>
<b>Drain Valves</b>
<b>Ground Plugs</b>
<b>Truck Valves</b>
<b>Selector Valves</b>
<b>Brass Fittings</b>
<b>Hose &amp; Tube Chart</b>
<b>Dash Control Valves</b>
<b>Air Brake Valves</b>
<b>Air Accessory Valves</b>
<b>Air Cylinders</b>
<b>Switches &amp; Toggles</b>
<b>Plugs, Sockets &amp; Cables</b>
<b>RV Plugs &amp; Sockets</b>
<b>Wire &amp; Cable</b>
<b>Electrical Harnesses</b>
<b>Electrical Connectors</b>
<b>Fuel Caps</b>
<b>Oil Caps &amp; Dipsticks</b>
<b>Grease Fittings</b>
<b>Water Pumps</b>
<b>Wiper Blades</b>
<b>Engine Heaters</b>
<b>Link Cat's Eye®</b>
<b>Hub Caps, Axilok® &amp; Securex®</b>
<b>Flitz</b>
<b>MAXXGreen</b>

• Item is available packaged, order with suffix - "P".



## Female Coupling



Sloan No.	Pipe Thread
S207-2	1/8
S207-4	1/4
S207-6	3/8
S207-8	1/2
S207-12	3/4

Ref. SAE 130138

## Slotted Plug



Sloan No.	Pipe Thread
S220P-2	1/8
S220P-4	1/4
S220P-6	3/8

## Square Head Plug



Sloan No.	Pipe Thread
S211-2	1/8
S211-4	1/4
S211-6	3/8
S211-8	1/2
S211-12	3/4

Ref. SAE 130109

## 45° Street Elbow



Sloan No.	Pipe Thread
S224-2	1/8
S224-4	1/4
S224-6	3/8
S224-8	1/2

Ref. SAE 130339

## Cap



Sloan No.	Pipe Thread
S213-2	1/8
S213-4	1/4
S213-6	3/8
S213-8	1/2

## Street Tee



Sloan No.	Male Pipe Thread	Female Pipe Thread
S225-2	1/8	1/8
S225-4	1/4	1/4
S225-6	3/8	3/8
S225-8	1/2	1/2

Ref. SAE 130424

## Close Nipple



Sloan No.	Pipe Thread
S215-2	1/8
S215-4	1/4
S215-6	3/8
S215-8	1/2
S215-12	3/4

## Male Branch Tee



Sloan No.	Male Pipe Thread	Female Pipe Thread
S226-2	1/8	1/8
S226-4	1/4	1/4
S226-6	3/8	3/8
S226-8	1/2	1/2
S226-12	3/4	3/4

Ref. SAE 130425

• Item is available packaged, order with suffix - "P".

# Pipe Fittings

## Hex Nipple Straight and Reducing



Sloan No.	Pipe Thread	
	1	2
SPHN-2	1/8	1/8
SPHN-4-2	1/4	1/8
SPHN-4	1/4	1/4
SPHN-6-2	3/8	1/8
SPHN-6-4	3/8	1/4
SPHN-6	3/8	3/8
SPHN-8-4	1/2	1/4
SPHN-8-6	1/2	3/8
SPHN-8	1/2	1/2
SPHN-12	3/4	3/4
SPHN-12-8	3/4	1/2

Ref. SAE 130137

## Countersunk Hex-Head Plug



Sloan No.	Pipe Thread	
	Hex	
S219P-2	1/8	3/16
S219P-4	1/4	1/4
S219P-6	3/8	5/16
S219P-8	1/2	3/8
S219P-12	3/4	9/16

## Hex Nipple Straight and Reducing - Steel



Sloan No.	Pipe Thread	
	1	2
HPHN-8-8	1/2	1/2
HPHN-12-8	3/4	1/2
HPHN-12-12	3/4	3/4

## Reducer Bushing



Sloan No.	Male Pipe Thread	Female Pipe Thread
	SPRB-4-2	1/4
SPRB-6-2	3/8	1/8
SPRB-6-4	3/8	1/4
SPRB-8-2	1/2	1/8
SPRB-8-4	1/2	1/4
SPRB-8-6	1/2	3/8
SPRB-12-2	3/4	1/8
SPRB-12-4	3/4	1/4
SPRB-12-6	3/4	3/8
SPRB-12-8	3/4	1/2
SPRB-16-12	1	3/4

Ref. SAE 130430

## Hex Head Plug



Sloan No.	Pipe Thread
SPPH-2	1/8
SPPH-4	1/4
SPPH-6	3/8
SPPH-8	1/2
SPPH-12	3/4

Ref. SAE 130109 E

- Tramec
- Rubber Hose Assemblies
- Coiled Air Assemblies
- 3-in-1 & 4-in-1 Wraps
- Bulk Hose
- Air Compressor Discharge Hose Assemblies
- Quick Fix™
- Air Hose Accessories
- Hose Clamps
- Gladhands & Accessories
- Air Tanks
- Drain Valves
- Ground Plugs
- Truck Valves
- Selector Valves
- Brass Fittings
- Hose & Tube Chart
- Dash Control Valves
- Air Brake Valves
- Air Accessory Valves
- Air Cylinders
- Switches & Toggles
- Plugs, Sockets & Cables
- RV Plugs & Sockets
- Wire & Cable
- Electrical Harnesses
- Electrical Connectors
- Fuel Caps
- Oil Caps & Dipsticks
- Grease Fittings
- Water Pumps
- Wiper Blades
- Engine Heaters
- Link Cat's Eye®
- Hub Caps, Axilok® & Securex®
- Flitz
- MAXXGreen

• Item is available packaged, order with suffix - "P".

## Hose Barb Spicer



Sloan No.	Hose Size
S73-3	3/16
S73-4	1/4
S73-5	5/16
S73-6	3/8
S73-8	1/2

## Hose Barb to Female Pipe



Sloan No.	Hose Size	Pipe Thread
S126-2-2	1/8	1/8
S126-3-2	3/16	1/8
S126-4-2	1/4	1/8
S126-4-4	1/4	1/4
126-4-6	1/4	3/8
S126-5-2	5/16	1/8
S126-5-4	5/16	1/4
S126-6-2	3/8	1/8
S126-6-4	3/8	1/4
S126-6-6	3/8	3/8
S126-6-8	3/8	1/2
S126-8-4	1/2	1/4
S126-8-6	1/2	3/8
S126-8-8	1/2	1/2
S126-12-12	3/4	3/4

## Hose Barb to Male Pipe



Sloan No.	Hose Size	Pipe Thread
S125-2-2	1/8	1/8
S125-2-4	1/8	1/4
S125-3-2	3/16	1/8
S125-3-4	3/16	1/4
S125-4-2	1/4	1/8
S125-4-4	1/4	1/4
S125-4-6	1/4	3/8
S125-4-8	1/4	1/2
S125-5-2	5/16	1/8
S125-5-4	5/16	1/4
S125-5-6	5/16	3/8
S125-6-2	3/8	1/8
S125-6-4	3/8	1/4
S125-6-6	3/8	3/8
S125-6-8	3/8	1/2
S125-8-4	1/2	1/4
S125-8-6	1/2	3/8
S125-8-8	1/2	1/2
S125-8-12	1/2	3/4
S125-10-6	5/8	3/8
S125-10-8	5/8	1/2
S125-10-12	5/8	3/4
S125-12-8	3/4	1/2
S125-12-12	3/4	3/4
S125-16-12	1	3/4
S125-16-16	1	1

## Ball Joint Adapter to Male Pipe Fitting for use with 128 series



Sloan No.	Straight Thread	Pipe Thread
S127-4-2	1/4 NPSM	1/8
S127-4-4	1/4 NPSM	1/4
S127-6-4	3/8 NPSM	1/4
S127-6-6	3/8 NPSM	3/8
S127-8-6	1/2 NPSM	3/8
S127-8-8	1/2 NPSM	1/2

## Hose Barb to Swivel Female Ball End



Sloan No.	Hose Size	Straight Thread
S128-4-4	1/4	1/4 NPSM
S128-5-4	5/16	1/4 NPSM
S128-6-4	3/8	1/4 NPSM
S128-6-6	3/8	3/8 NPSM
S128-8-6	1/2	3/8 NPSM
S128-8-8	1/2	1/2 NPSM
S128-12-12	3/4	3/4 NPSM

# Hose Barb

## 90° Hose Barb Elbow to Male Pipe



Sloan No.	Hose Size	Pipe Thread
S129-4-2	1/4	1/8
S129-4-4	1/4	1/4
S129-5-2	5/16	1/8
S129-5-4	5/16	1/4
S129-5-6	5/16	3/8
S129-6-2	3/8	1/8
S129-6-4	3/8	1/4
S129-6-6	3/8	3/8
S129-6-8	3/8	1/2
S129-8-4	1/2	1/4
S129-8-6	1/2	3/8
S129-8-8	1/2	1/2
S129-10-6	5/8	3/8
S129-10-8	5/8	1/2

## Hose Barb Tee



Sloan No.	Hose Size
SHBT2-6	3/8

## 45° Hose Barb Elbow to Male Pipe



Sloan No.	Hose Size	Pipe Thread
S139-4-2	1/4	1/8
S139-5-2	5/16	1/8
S139-5-4	5/16	1/4
S139-6-2	3/8	1/8
S139-6-4	3/8	1/4
S139-6-6	3/8	3/8
S139-8-4	1/2	1/4
S139-8-6	1/2	3/8
S139-10-6	5/8	3/8

## Hose Barb Tee x Male Pipe on Branch



Sloan No.	Hose Size	Pipe Thread
SHBT1-6-6-4	3/8	1/4

## Hose Barb to Swivel Female Flare



Sloan No.	Hose Size	Straight Thread
S146-4-4	1/4	7/16-20
S146-4-6	1/4	5/8-18
S146-6-6	3/8	5/8-18
S146-6-8	3/8	3/4-16
S146-8-8	1/2	3/4-16

Tramec
Rubber Hose Assemblies
Coiled Air Assemblies
3-in-1 & 4-in-1 Wraps
Bulk Hose
Air Compressor Discharge Hose Assemblies
Quick Fix™
Air Hose Accessories
Hose Clamps
Gladhands & Accessories
Air Tanks
Drain Valves
Ground Plugs
Truck Valves
Selector Valves
Brass Fittings
Hose & Tube Chart
Dash Control Valves
Air Brake Valves
Air Accessory Valves
Air Cylinders
Switches & Toggles
Plugs, Sockets & Cables
RV Plugs & Sockets
Wire & Cable
Electrical Harnesses
Electrical Connectors
Fuel Caps
Oil Caps & Dipsticks
Grease Fittings
Water Pumps
Wiper Blades
Engine Heaters
Link Cat's Eye®
Hub Caps, Axilok® & Securex®
Flitz
MAXXGreen

# Push-On Fittings

## Male Hose Barb



Part Number	Hose Size	Pipe Thread
S625-4-2	1/4	1/8
S625-4-4	1/4	1/4
S625-4-6	1/4	3/8
S625-5-2	5/16	1/8
S625-5-4	5/16	1/4
S625-6-2	3/8	1/8
S625-6-4	3/8	1/4
S625-6-6	3/8	3/8
S625-6-8	3/8	1/2
S625-6-12	3/8	3/4
S625-8-4	1/2	1/4
S625-8-6	1/2	3/8
S625-8-8	1/2	1/2
S625-8-12	1/2	3/4
S625-10-6	5/8	3/8
S625-10-8	5/8	1/2
S625-10-12	5/8	3/4
S625-12-8	3/4	1/2
S625-12-12	3/4	3/4

## Female Swivel Hose Barb 45° SAE Flare



Part Number	Hose Size	Tube Size	Thread Size
S684-5-6	5/16	3/8	5/8-18
S684-6-6	3/8	3/8	5/8-18
S684-12-12	3/4	3/4	*1-1/16-14

\* Notch in nut for SAE identification

## Female Swivel Hose Barb 37° JIC Flare



Part Number	Hose Size	Tube Size	Thread Size
S688-6-6	3/8	3/8	9/16-18
S688-12-12	3/4	3/4	1-1/16-12

## Male Hose Barb 45° SAE Flare



Part Number	Hose Size	Tube Size	Thread Size
S682-4-4	1/4	1/4	7/16-20
S682-4-5	1/4	5/16	1/2-20
S682-6-5	3/8	5/16	1/2-20
S682-6-6	3/8	3/8	5/8-18
S682-6-8	3/8	1/2	3/4-16
S682-8-8	1/2	1/2	3/4-16
S682-10-8	5/8	1/2	3/4-16
S682-10-10	5/8	5/8	7/8-14
S682-12-10	3/4	5/8	7/8-14

## SAE Inverted Flare Male Swivel Hose Barb



Part Number	Hose Size	Tube Size	Thread Size
S690-4-3	1/4	3/16	3/8-24
S690-4-4	1/4	1/4	7/16-24
S690-5-4	5/16	1/4	7/16-24
S690-5-5	5/16	5/16	1/2-20
S690-5-6	5/16	3/8	5/8-18
S690-6-5	3/8	5/16	1/2-20
S690-6-6	3/8	3/8	5/8-18
S690-8-8	1/2	1/2	3/4-18
S690-10-10	5/8	5/8	7/8-18

# Push-On Fittings

## SAE Inverted Flare Rigid Female Hose Barb



Part Number	Hose Size	Tube Size	Thread Size
S692-4-3	1/4	3/16	3/8-24
S692-4-4	1/4	1/4	7/16-24
S692-4-5	1/4	5/16	1/2-20
S692-6-5	3/8	5/16	1/2-20
S692-6-6	3/8	3/8	5/8-18
S692-8-8	1/2	1/2	3/4-18

## Rigid Tube Shank Hose Barb



Part Number	Hose Size	Tube Size
S694-4-3	1/4	3/16
S694-4-4	1/4	1/4
S694-4-5	1/4	5/16
S694-6-6	3/8	3/8
S694-8-8	1/2	1/2
S694-10-10	5/8	5/8

## Hose Splicer



Part Number	Hose Size
S696-4	1/4
S696-5	5/16
S696-6	3/8
S696-8	1/2

- Tramec
- Rubber Hose Assemblies
- Coiled Air Assemblies
- 3-in-1 & 4-in-1 Wraps
- Bulk Hose
- Air Compressor Discharge Hose Assemblies
- Quick Fix™
- Air Hose Accessories
- Hose Clamps
- Gladhands & Accessories
- Air Tanks
- Drain Valves
- Ground Plugs
- Truck Valves
- Selector Valves
- Brass Fittings**
- Hose & Tube Chart
- Dash Control Valves
- Air Brake Valves
- Air Accessory Valves
- Air Cylinders
- Switches & Toggles
- Plugs, Sockets & Cables
- RV Plugs & Sockets
- Wire & Cable
- Electrical Harnesses
- Electrical Connectors
- Fuel Caps
- Oil Caps & Dipsticks
- Grease Fittings
- Water Pumps
- Wiper Blades
- Engine Heaters
- Link Cat's Eye®
- Hub Caps, Axilok® & Securex®
- Flitz
- MAXXGreen

## Tube Nut - Steel



Sloan No.	Tube Size
S41IFS-2	1/8
S41IFS-3	3/16
S41IFS-4	1/4
S41IFS-5	5/16
S41IFS-6	3/8
S41IFS-8	1/2
S41IFS-10	5/8
S41IFS-12	3/4

## Male Connector



Sloan No.	Tube Size	Pipe Thread
S48IF-2-2	1/8	1/8
S48IF-3-2	3/16	1/8
S48IF-4-2	1/4	1/8
S48IF-4-4	1/4	1/4
S48IF-5-2	5/16	1/8
S48IF-5-4	5/16	1/4
S48IF-6-2	3/8	1/8
S48IF-6-4	3/8	1/4
S48IF-6-6	3/8	3/8
S48IF-8-4	1/2	1/4
S48IF-8-6	1/2	3/8
S48IF-8-8	1/2	1/2
S48IF-10-8	5/8	1/2

## Tube Nut - Brass



Sloan No.	Tube Size
S41IF-3	3/16
S41IF-4	1/4
S41IF-5	5/16
S41IF-6	3/8
S41IF-8	1/2

## Male Branch Tee

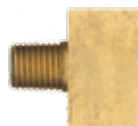

Sloan No.	Tube Size	Pipe Thread
S245IF-3-2	3/16	1/8
S245IF-4-2	1/4	1/8
S245IF-5-2	5/16	1/8
S245IF-6-4	3/8	1/4

## Union Flare



Sloan No.	Tube Size
S42IF-2	1/8
S42IF-3	3/16
S42IF-4	1/4
S42IF-5	5/16
S42IF-6	3/8
S42IF-8	1/2

## Male Elbow



Sloan No.	Tube Size	Pipe Thread
S249IF-2-2	1/8	1/8
S249IF-3-2	3/16	1/8
S249IF-4-2	1/4	1/8
S249IF-4-4	1/4	1/4
S249IF-5-2	5/16	1/8
S249IF-5-4	5/16	1/4
S249IF-6-2	3/8	1/8
S249IF-6-4	3/8	1/4
S249IF-6-6	3/8	3/8
S249IF-8-4	1/2	1/4
S249IF-8-6	1/2	3/8
S249IF-8-8	1/2	1/2
S249IF-10-6	5/8	3/8
S249IF-10-8	5/8	1/2

## Union Tee



Sloan No.	Tube Size
S244IF-3	3/16
S244IF-4	1/4
S244IF-5	5/16
S244IF-6	3/8
S244IF-8	1/2

## Female Connector



Sloan No.	Tube Size	Pipe Thread
S46IF-3-2	3/16	1/8
S46IF-4-2	1/4	1/8
S46IF-5-2	5/16	1/8
S46IF-6-4	3/8	1/4
S46IF-8-6	1/2	3/8

## 45° Elbow



Sloan No.	Tube Size	Pipe Thread
S259IF-3-2	3/16	1/8
S259IF-4-2	1/4	1/8
S259IF-5-2	5/16	1/8
S259IF-5-4	5/16	1/4
S259IF-6-4	3/8	1/4

• Item is available packaged, order with suffix - "P".

# 45 Degree Flare

## Flare Plug



Sloan No.	Tube Size
S39-4	1/4
S39-5	5/16
S39-6	3/8
S39-8	1/2
S39-10	5/8

## Flare Cap



Sloan No.	Tube Size
S40-3	3/16
S40-4	1/4
S40-5	5/16
S40-6	3/8
S40-8	1/2
S40-10	5/8

## Flare Nut - Short



Sloan No.	Tube Size
S41S-2	1/8
S41S-3	3/16
S41S-4	1/4
S41S-5	5/16
S41S-6	3/8
S41S-6-4	3/8 to 1/4
S41S-7	7/16
S41S-8	1/2
S41S-8-6	1/2 to 3/8
S41S-10	5/8
S41S-12	3/4
S41S-14	7/8

## Flare Nut - Long



Sloan No.	Tube Size
S41L-4	1/4
S41L-5	5/16
S41L-6*	3/8
S41L-8	1/2
S41L-10	5/8

Ref. SAE 01011 (\*Non SAE)

## Flare Union Tube Both Ends



Sloan No.	Tube Size	
	1	2
S42-2	1/8	1/8
S42-3	3/16	3/16
S42-4	1/4	1/4
S42-5	5/16	5/16
S42-6-4	3/8	1/4
S42-6-5	3/8	5/16
S42-6	3/8	3/8
S42-8-4	1/2	1/4
S42-8-6	1/2	3/8
S42-8	1/2	1/2
S42-10-6	5/8	3/8
S42-10-8	5/8	1/2
S42-10	5/8	5/8
S42-12-8	3/4	1/2
S42-12	3/4	3/4
S42-14	7/8	7/8

Ref. SAE 010101

## Flare Tee Tube All 3 Ends



Sloan No.	Tube Size
S44-3*	3/16
S44-4*	1/4
S44-5*	5/16
S44-6	3/8
S44-8	1/2
S44-10	5/8

Ref. SAE 010401 (\*Non SAE)

## Flare Reducing Tee Tube All 3 Ends



Sloan No.	Tube Size		
	1	2	3
S44-6-6-8	3/8	3/8	1/2
S44-8-6-6	1/2	3/8	3/8
S44-8-6-8	1/2	3/8	1/2
S44-8-8-6	1/2	1/2	3/8
S44-10-6-6*	5/8	3/8	3/8
S44-10-10-8*	5/8	5/8	1/2

Ref. SAE 010401 (\*Non SAE)

## Flare Tee w/ Male Pipe Thread on Branch



Sloan No.	Tube Size	Pipe Thread
S45-6-2	3/8	1/8

Tramec
Rubber Hose Assemblies
Coiled Air Assemblies
3-in-1 & 4-in-1 Wraps
Bulk Hose
Air Compressor Discharge Hose Assemblies
Quick Fix™
Air Hose Accessories
Hose Clamps
Gladhands & Accessories
Air Tanks
Drain Valves
Ground Plugs
Truck Valves
Selector Valves
Brass Fittings
Hose & Tube Chart
Dash Control Valves
Air Brake Valves
Air Accessory Valves
Air Cylinders
Switches & Toggles
Plugs, Sockets & Cables
RV Plugs & Sockets
Wire & Cable
Electrical Harnesses
Electrical Connectors
Fuel Caps
Oil Caps & Dipsticks
Grease Fittings
Water Pumps
Wiper Blades
Engine Heaters
Link Cat's Eye®
Hub Caps, Axilok® & Securex®
Flitz
MAXXGreen



## Flare x F.I.P Union



Sloan No.	Tube Size	Pipe Thread
S46-3-2	3/16	1/8
S46-4-2	1/4	1/8
S46-4-4	1/4	1/4
S46-4-6	1/4	3/8
S46-4-8	1/4	1/2
S46-5-2	5/16	1/8
S46-5-4	5/16	1/4
S46-6-2	3/8	1/8
S46-6-4	3/8	1/4
S46-6-6	3/8	3/8
S46-6-8	3/8	1/2
S46-6-12	3/8	3/4
S46-8-4	1/2	1/4
S46-8-6	1/2	3/8
S46-8-8	1/2	1/2
S46-8-12	1/2	3/4
S46-10-6	5/8	3/8
S46-10-8	5/8	1/2
S46-10-12	5/8	3/4
S46-12-12	3/4	3/4
S46-14-12	7/8	3/4

## Flare x M.I.P Union



Sloan No.	Tube Size	Pipe Thread
S48-2-2	1/8	1/8
S48-3-2	3/16	1/8
S48-3-4	3/16	1/4
S48-4-2	1/4	1/8
S48-4-4	1/4	1/4
S48-4-6	1/4	3/8
S48-4-8	1/4	1/2
S48-5-2	5/16	1/8
S48-5-4	5/16	1/4
S48-5-6	5/16	3/8
S48-6-2	3/8	1/8
S48-6-4	3/8	1/4
S48-6-6	3/8	3/8
S48-6-8	3/8	1/2
S48-6-12	3/8	3/4
S48-8-4	1/2	1/4
S48-8-6	1/2	3/8
S48-8-8	1/2	1/2
S48-8-12	1/2	3/4
S48-10-4	5/8	1/4
S48-10-6	5/8	3/8
S48-10-8	5/8	1/2
S48-10-12	5/8	3/4
S48-12-8	3/4	1/2
S48-12-12	3/4	3/4
S48-14-12	7/8	3/4

## Flare Female Sweat Union



Sloan No.	Tube Size
S46FS-6-6	3/8
S46FS-8-8	1/2
S46FS-10-10	5/8

## Flare x M.I.P Elbow



Sloan No.	Tube Size	Pipe Thread
S49-3-2*	3/16	1/8
S49-4-2*	1/4	1/8
S49-4-4*	1/4	1/4
S49-4-6*	1/4	3/8
S49-5-2	5/16	1/8
S49-5-4	5/16	1/4
S49-6-2*	3/8	1/8
S49-6-4	3/8	1/4
S49-6-6	3/8	3/8
S49-6-8	3/8	1/2
S49-8-4	1/2	1/4
S49-8-6	1/2	3/8
S49-8-8	1/2	1/2
S49-10-8*	5/8	1/2

## Flare x F.I.P Elbow



Sloan No.	Tube Size	Pipe Thread
S50-6-6	3/8	3/8
S50-6-8	3/8	1/2
S50-8-8	1/2	1/2
S50-10-8	5/8	1/2
S50-10-12	5/8	3/4

Ref. SAE 010202 (\*Non SAE)

# 45 Degree Flare

## Flare Elbow Tube Both Ends



Sloan No.	Tube Size
S55-3	3/16
S55-4	1/4
S55-6	3/8
S55-8	1/2
S55-10	5/8

## Forged Refrigeration Nut - Short



Sloan No.	Tube Size
S141S-3	3/16
S141S-4	1/4
S141S-5	5/16
S141S-6-4	3/8 to 1/4
S141S-6-5	3/8 to 5/16
S141S-6	3/8
S141S-8-6	1/2 to 3/8
S141S-8	1/2
S141S10-8	5/8 to 1/2
S141S-10	5/8
S141S-12	3/4
S141S-14	7/8

## Forged Swivel Nut Valve Connector



Sloan No.	Tube Size
S114FSV-4	1/4
S114FSV-5	5/16
S114FSV-6	3/8
S114FSV-8	1/2
S114FSV-10	5/8

## Forged Flare Tee Tube All 3 Ends



Sloan No.	Tube Size		
	1	2	3
S144-2	1/8	1/8	1/8
S144-3	3/16	3/16	3/16
S144-4	1/4	1/4	1/4
S144-4-4-6	1/4	1/4	3/8
S144-5	5/16	5/16	5/16
S144-6-6-4	3/8	3/8	1/4
S144-6	3/8	3/8	3/8
S144-6-6-8	3/8	3/8	1/2
S144-6-10-10	3/8	5/8	5/8
S144-8-6-6	1/2	3/8	3/8
S144-8-6-8	1/2	3/8	1/2
S144-8-8-4	1/2	1/2	1/4
S144-8-8-6	1/2	1/2	3/8
S144-8	1/2	1/2	1/2
S144-8-8-10	1/2	1/2	5/8
S144-10-6-6	5/8	3/8	3/8
S144-10-8-6	5/8	1/2	3/8
S144-10-8-10	5/8	1/2	5/8
S144-10-10-6	5/8	5/8	3/8
S144-10-10-8	5/8	5/8	1/2
S144-10	5/8	5/8	5/8
S144-12	3/4	3/4	3/4
S144-14	7/8	7/8	7/8

## Forged Flare Tee w/Female Pipe Thread on Branch



Sloan No.	Tube Size	Pipe Thread
S136-6-6	3/8	3/8
S136-6-8	3/8	1/2
S136-8-8	1/2	1/2

## Forged Refrigeration Nut - Long



Sloan No.	Tube Size
S141L-4	1/4
S141L-5	5/16
S141L-6	3/8
S141L-8	1/2
S141L-10	5/8
S141L-12	3/4

- Tramec
- Rubber Hose Assemblies
- Coiled Air Assemblies
- 3-in-1 & 4-in-1 Wraps
- Bulk Hose
- Air Compressor Discharge Hose Assemblies
- Quick Fix™
- Air Hose Accessories
- Hose Clamps
- Gladhands & Accessories
- Air Tanks
- Drain Valves
- Ground Plugs
- Truck Valves
- Selector Valves
- Brass Fittings
- Hose & Tube Chart
- Dash Control Valves
- Air Brake Valves
- Air Accessory Valves
- Air Cylinders
- Switches & Toggles
- Plugs, Sockets & Cables
- RV Plugs & Sockets
- Wire & Cable
- Electrical Harnesses
- Electrical Connectors
- Fuel Caps
- Oil Caps & Dipsticks
- Grease Fittings
- Water Pumps
- Wiper Blades
- Engine Heaters
- Link Cat's Eye®
- Hub Caps, Axilok® & Securex®
- Flitz
- MAXXGreen

# 45 Degree Flare

## Forged Flare Tee w/ Male Pipe Thread on Branch



Sloan No.	Tube Size	Pipe Thread
S145-3-2	3/16	1/8
S145-4-2	1/4	1/8
S145-4-4	1/4	1/4
S145-5-2	5/16	1/8
S145-5-4	5/16	1/4
S145-6-4	3/8	1/4
S145-6-6	3/8	3/8
S145-6-8	3/8	1/2
S145-8-6	1/2	3/8
S145-8-8	1/2	1/2
S145-10-8	5/8	1/2
S145-12-8	3/4	1/2
S145-12-12	3/4	3/4

## Forged Flare x F.I.P. Elbow



Sloan No.	Tube Size	Pipe Thread
S150-3-2	3/16	1/8
S150-4-2	1/4	1/8
S150-4-4	1/4	1/4
S150-4-6	1/4	3/8
S150-5-2	5/16	1/8
S150-5-4	5/16	1/4
S150-6-2	3/8	1/8
S150-6-4	3/8	1/4
S150-6-6	3/8	3/8
S150-6-8	3/8	1/2
S150-6-12	3/8	3/4
S150-8-4	1/2	1/4
S150-8-6	1/2	3/8
S150-8-8	1/2	1/2
S150-8-12	1/2	3/4
S150-10-6	5/8	3/8
S150-10-8	5/8	1/2
S150-10-12	5/8	3/4

## Forged Flare x M.I.P. Elbow



Sloan No.	Tube Size	Pipe Thread
S149-2-2	1/8	1/8
S149-3-2	3/16	1/8
S149-4-2	1/4	1/8
S149-4-4	1/4	1/4
S149-4-6	1/4	3/8
S149-4-8	1/4	1/2
S149-5-2	5/16	1/8
S149-5-4	5/16	1/4
S149-5-6	5/16	3/8
S149-5-8	5/16	1/2
S149-6-2	3/8	1/8
S149-6-4	3/8	1/4
S149-6-6	3/8	3/8
S149-6-8	3/8	1/2
S149-8-4	1/2	1/4
S149-8-6	1/2	3/8
S149-8-8	1/2	1/2
S149-8-12	1/2	3/4
S149-10-4	5/8	1/4
S149-10-6	5/8	3/8
S149-10-8	5/8	1/2
S149-10-12	5/8	3/4
S149-12-8	3/4	1/2
S149-12-12	3/4	3/4



## Forged Flare Tee w/ Male Pipe Thread on Run



Sloan No.	Tube Size	Pipe Thread
S151-3-2	3/16	1/8
S151-4-2	1/4	1/8
S151-4-4	1/4	1/4
S151-5-4	5/16	1/4
S151-6-2	3/8	1/8
S151-6-4	3/8	1/4
S151-6-6	3/8	3/8
S151-8-6	1/2	3/8
S151-8-8	1/2	1/2
S151-10-8	5/8	1/2

## Forged Flare Cross w/Female Pipe Thread



Sloan No.	Tube Size
S152-4	1/4
S152-6	3/8
S152-8	1/2

# 45 Degree Flare

## Forged Flare Elbow Tube Both Ends



Sloan No.	Tube Size	
	1	2
S155-3	3/16	3/16
S155-4	1/4	1/4
S155-5	5/16	5/16
S155-6	3/8	3/8
S155-8-6	1/2	3/8
S155-8	1/2	1/2
S155-10-6	5/8	3/8
S155-10-8	5/8	1/2
S155-10	5/8	5/8
S155-14	7/8	7/8

## Forged Flare Cross w/Female Pipe Thread



Sloan No.	Tube Size	Pipe Thread
SFFX1-6-8	3/8	1/2
SFFX1-8-8	1/2	1/2

## Forged Flare x M.I.P. 45° Elbow



Sloan No.	Tube Size	Pipe Thread
S159-4-2	1/4	1/8
S159-4-4	1/4	1/4
S159-6-4	3/8	1/4
S159-6-6	3/8	3/8
S159-8-6	1/2	3/8
S159-10-8	5/8	1/2

## Flare Bonnet



Sloan No.	Tube Size
SFB-3	3/16
SFB-4	1/4
SFB-5	5/16
SFB-6	3/8
SFB-8	1/2
SFB-10	5/8
SFB-12	3/4

Ref. SAE 010114

## Forged Flare Tee w/Female Pipe Thread on Run



Sloan No.	Tube Size	Pipe Thread
ST5-6-8	3/8	1/2

## Flare Gasket



Sloan No.	Tube Size
SFG-3	3/16
SFG-4	1/4
SFG-5	5/16
SFG-6	3/8
SFG-8	1/2
SFG-10	5/8
SFG-12	3/4

Ref. SAE 010113

- Tramec
- Rubber Hose Assemblies
- Coiled Air Assemblies
- 3-in-1 & 4-in-1 Wraps
- Bulk Hose
- Air Compressor Discharge Hose Assemblies
- Quick Fix™
- Air Hose Accessories
- Hose Clamps
- Gladhands & Accessories
- Air Tanks
- Drain Valves
- Ground Plugs
- Truck Valves
- Selector Valves
- Brass Fittings
- Hose & Tube Chart
- Dash Control Valves
- Air Brake Valves
- Air Accessory Valves
- Air Cylinders
- Switches & Toggles
- Plugs, Sockets & Cables
- RV Plugs & Sockets
- Wire & Cable
- Electrical Harnesses
- Electrical Connectors
- Fuel Caps
- Oil Caps & Dipsticks
- Grease Fittings
- Water Pumps
- Wiper Blades
- Engine Heaters
- Link Cat's Eye®
- Hub Caps, Axilok® & Securex®
- Flitz
- MAXXGreen

## Sleeve



Sloan No.	Tube Size
S260AB-4	1/4
S260AB-6	3/8
S260AB-8	1/2
S260AB-10	5/8
S260AB-12	3/4

## Female Connector



Sloan No.	Tube Size	Pipe Thread
S266AB-6-4	3/8	1/4
S266AB-6-6	3/8	3/8

## Nut



Sloan No.	Tube Size
S261AB-4	1/4
S261AB-6	3/8
S261AB-8	1/2
S261AB-10	5/8
S261AB-12	3/4

Ref. SAE 120111

## Male Connector



Sloan No.	Tube Size	Pipe Thread
S268AB-4-2	1/4	1/8
S268AB-4-4	1/4	1/4
S268AB-4-6	1/4	3/8
S268AB-6-2	3/8	1/8
S268AB-6-4	3/8	1/4
S268AB-6-6	3/8	3/8
S268AB-6-8	3/8	1/2
S268AB-8-4	1/2	1/4
S268AB-8-6	1/2	3/8
S268AB-8-8	1/2	1/2
S268AB-10-6	5/8	3/8
S268AB-10-8	5/8	1/2
S268AB-12-8	3/4	1/2
S268AB-12-12	3/4	3/4

Ref. SAE 120102 BA

## Union



Sloan No.	Tube Size
S262AB-4	1/4
S262AB-6	3/8
S262AB-8	1/2
S262AB-10	5/8
S262AB-12	3/4

Ref. SAE 120101 BA

## Union Tee



Sloan No.	Tube Size
S264AB-6	3/8
S264AB-8	1/2

Ref. SAE 120401 BA

## Male Elbow



Sloan No.	Tube Size	Pipe Thread
S269AB-4-2	1/4	1/8
S269AB-4-4	1/4	1/4
S269AB-4-6	1/4	3/8
S269AB-6-2	3/8	1/8
S269AB-6-4	3/8	1/4
S269AB-6-6	3/8	3/8
S269AB-6-8	3/8	1/2
S269AB-8-4	1/2	1/4
S269AB-8-6	1/2	3/8
S269AB-8-8	1/2	1/2
S269AB-10-6	5/8	3/8
S269AB-10-8	5/8	1/2

Ref. SAE 120202 BA

## Union Elbow



Sloan No.	Tube Size
S265AB-6	3/8
S265AB-8	1/2

Ref. SAE 120201 BA

## Female Elbow



Sloan No.	Tube Size	Pipe Thread
S270AB-6-4	3/8	1/4
S270AB-6-6	3/8	3/8
S270AB-8-6	1/2	3/8

Ref. SAE 120203 BA

## Male Run Tee



Sloan No.	Tube Size	Pipe Thread
S271AB-6-4	3/8	1/4
S271AB-6-6	3/8	3/8
S271AB-8-6	1/2	3/8

## 45° Elbow



Sloan No.	Tube Size	Pipe Thread
S279AB-6-4	3/8	1/4
S279AB-6-6	3/8	3/8
S279AB-8-6	1/2	3/8
S279AB-10-8	5/8	1/2

Ref. SAE 120302 BA

## Male Branch Tee



Sloan No.	Tube Size	Pipe Thread
S272AB-6-2	3/8	1/8
S272AB-6-4	3/8	1/4
S272AB-6-6	3/8	3/8
S272AB-8-6	1/2	3/8

Ref. SAE 120425 BA

- Tramec
- Rubber Hose Assemblies
- Coiled Air Assemblies
- 3-in-1 & 4-in-1 Wraps
- Bulk Hose
- Air Compressor Discharge Hose Assemblies
- Quick Fix™
- Air Hose Accessories
- Hose Clamps
- Gladhands & Accessories
- Air Tanks
- Drain Valves
- Ground Plugs
- Truck Valves
- Selector Valves
- Brass Fittings
- Hose & Tube Chart
- Dash Control Valves
- Air Brake Valves
- Air Accessory Valves
- Air Cylinders
- Switches & Toggles
- Plugs, Sockets & Cables
- RV Plugs & Sockets
- Wire & Cable
- Electrical Harnesses
- Electrical Connectors
- Fuel Caps
- Oil Caps & Dipsticks
- Grease Fittings
- Water Pumps
- Wiper Blades
- Engine Heaters
- Link Cat's Eye®
- Hub Caps, Axilok® & Securex®
- Flitz
- MAXXGreen

# Terminal Bolts (Frame Couplers)

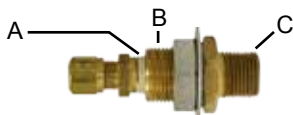
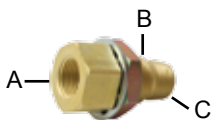
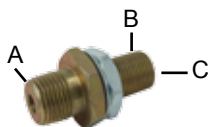
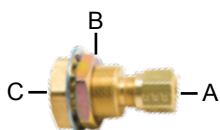
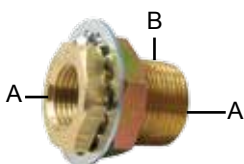
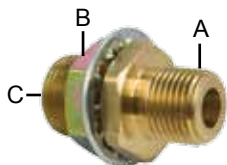
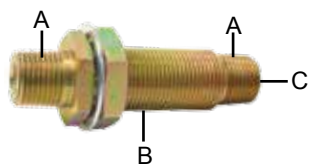

Part No.	A	B	C	Length
S600	1/2-14 NPTF	1-14 UNS	1/4-18 NPTF	2-7/8
S600L	1/2-14 NPTF	1-14 UNS	1/4-18 NPTF	2-7/8
(same as S600 except with larger mounting nut)				
S664*	1/2-14 NPTF	1-14 UNS	1/4-18 NPTF	3-15/16
S615	1/2-14 NPTF	1-14 UNS	1/4-18 NPTF	2-1/8
S620	1/2-14 NPTF	1-14 UNS	3/8-18 NPTF	1-11/16
S620V	1/2-14 NPTF	1-14 UNS	3/8-18 NPTF	1-11/16
(same as S620 except with Vibra Seal on A)				
S646	1/2-14 NPTF	1-14 UNS	3/8-18 NPTF	1-29/32
S607	3/8-18 NPTF	1-14 UNS	---	1-5/16
S611	1/4-18 NPTF	3/4-16 UNS	---	15/16
S661	1/4-18 NPTF	3/4-16 UNS	---	1-1/2
S661L	1/4-18 NPTF	3/4-16 UNS	---	1-1/2
(same as S661 except with larger mounting nut)				
S807	1/2-14 NPTF	1-1/8-14 UNS	---	1-1/2
S608	1/2 O.D. Tube	7/8-20 UNF	3/8-18 NPTF	1-5/16
S609	3/8 O.D. Tube	7/8-20 UNF	3/8-18 NPTF	1-3/8
S612*	1/2-14 NPTF	3/4-16 UNS	1/4-18 NPTF	1-11/16
S689*	1/2-14 NPTF	3/4-16 UNS	1/4-18 NPTF	2-5/32
S613	3/8-18 NPTF	1-14 UNS	1/2-14 NPTF	1-7/8
S629	1/2-14 NPTF	1-14 UNS	1/2-14 NPTF	2-3/8
S646-S768AB-6-6	3/8-18 NPTF	1-14 UNS	1/2-14 NPTF	3-3/8
(With NTA Fittings)				

\*Note: steel fittings

# Hose & Tube Chart

## Actual Outside Diameter of Pipe Threads

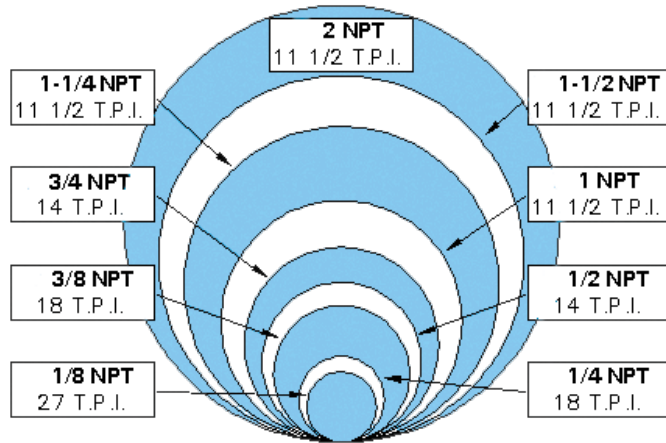

### Pipe Size Code

Code	Pipe Size
-1	1/16
-2	1/8
-4	1/4
-5	5/16
-6	3/8
-8	1/2
-10	5/8
-12	3/4
-14	7/8
-16	1
-20	1-1/4
-24	1-1/2
-32	2

## Actual Outside Diameter of Tubing

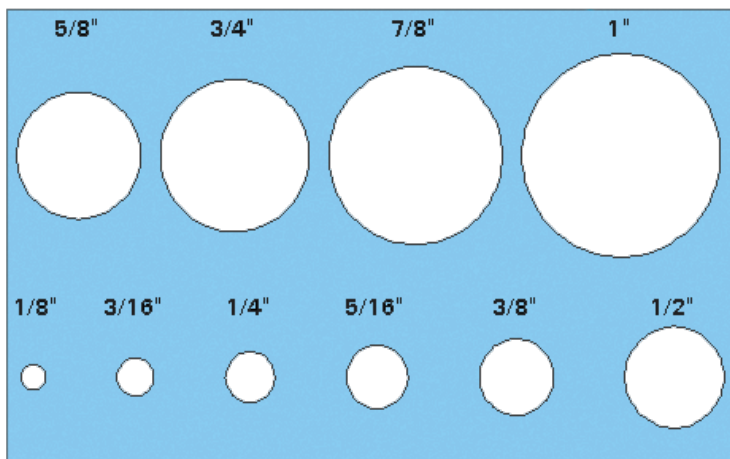

### Tube Size Code

Code	Tube Size
-2	1/8
-3	3/16
-4	1/4
-5	5/16
-6	3/8
-7	7/16
-8	1/2
-10	5/8
-12	3/4
-14	7/8
-16	1
-20	1-1/4
-24	1-1/2
-32	2

- Tramec
- Rubber Hose Assemblies
- Coiled Air Assemblies
- 3-in-1 & 4-in-1 Wraps
- Bulk Hose
- Air Compressor Discharge Hose Assemblies
- Quick Fix™
- Air Hose Accessories
- Hose Clamps
- Gladhands & Accessories
- Air Tanks
- Drain Valves
- Ground Plugs
- Truck Valves
- Selector Valves
- Brass Fittings
- Hose & Tube Chart
- Dash Control Valves
- Air Brake Valves
- Air Accessory Valves
- Air Cylinders
- Switches & Toggles
- Plugs, Sockets & Cables
- RV Plugs & Sockets
- Wire & Cable
- Electrical Harnesses
- Electrical Connectors
- Fuel Caps
- Oil Caps & Dipsticks
- Grease Fittings
- Water Pumps
- Wiper Blades
- Engine Heaters
- Link Cat's Eye®
- Hub Caps, Axilok® & Securex®
- Flitz
- MAXXGreen



# Hose & Tube Chart

Air Products

## Cardboard Display Boxes

- Great for organizing small parts.
- Fits on a standard 10" & 12".
- Made out of heavy duty cardboard for extended life.

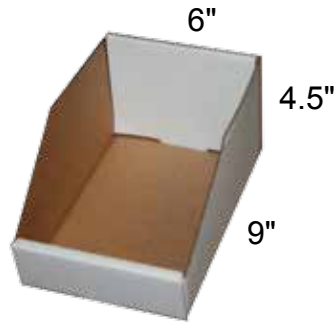

424177

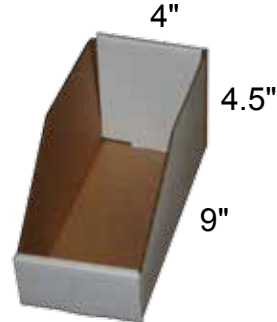

424176

## Brass Spin Display Rack Assortment

- Packaged in clear bags for easy part identification.
- Bag label includes Sloan part number, part description, graphic, quantity and competitor cross references.
- 4 blue panels with plan-o-gram.
- Attractive Sloan header sign.
- 93 6" hook pegs.
- Available fully stocked with brass fittings or as display rack only.
- Most effective and efficient way to merchandise brass fittings at point of purchase.

Spin Rack Empty	Spin Rack Assortment
S100	S101

## S101 Brass Spin Display Rack Assortment

Qty.	Sloan No.	Qty.	Sloan No.	Qty.	Sloan No.	Qty.	Sloan No.
1.....	S100	6.....	S225-6P	12.....	S762AB-8P	12.....	S769AB-6-8P
12.....	S120-4-2P	36.....	S360AB-6P	60.....	S763AB-10P	12.....	S769AB-8-4P
6.....	S120-6-4P	12.....	S368AB-6-4P	60.....	S763AB-4P	12.....	S769AB-8-6P
6.....	S120-8-6P	12.....	S368AB-6-6P	60.....	S763AB-6P	12.....	S769AB-8-8P
6.....	S202-2P	12.....	S368AB-6-8P	60.....	S763AB-8P	12.....	S772AB-4-2P
6.....	S202-4P	12.....	S378AB-6-4P	6.....	S764AB-4P	12.....	S772AB-6-4P
6.....	S202-6P	6.....	S378AB-6-6P	6.....	S764AB-6P	12.....	S779AB-4-2P
6.....	S202-8P	6.....	S378AB-6-8P	6.....	S768AB-10-6P	12.....	S779AB-6-2P
6.....	S203-2P	6.....	S48-10-8P	6.....	S768AB-10-8P	12.....	S779AB-6-6P
6.....	S203-4P	12.....	S48-4-2P	12.....	S768AB-4-2P	30.....	SPHN-4P
6.....	S203-6P	6.....	S48-8-6P	12.....	S768AB-4-4P	12.....	SPHN-6P
12.....	S207-2P	6.....	S49-10-8P	12.....	S768AB-4-6P	6.....	SPHN-8P
6.....	S207-4P	60.....	S760AB-10P	12.....	S768AB-6-2P	6.....	SPPH-12P
6.....	S207-6P	60.....	S760AB-12P	12.....	S768AB-6-4P	60.....	SPPH-2P
6.....	S207-8P	60.....	S760AB-4P	12.....	S768AB-6-6P	30.....	SPPH-4P
30.....	S211-2P	60.....	S760AB-6P	6.....	S768AB-6-8P	12.....	SPPH-6P
30.....	S211-4P	60.....	S760AB-8P	12.....	S768AB-8-4P	6.....	SPRB-12-8P
12.....	S211-6P	60.....	S761AB-4P	12.....	S768AB-8-6P	30.....	SPRB-4-2P
6.....	S211-8P	60.....	S761AB-6P	6.....	S768AB-8-8P	12.....	SPRB-6-2P
60.....	S215-2P	24.....	S761AB-8P	12.....	S769AB-10-8P	30.....	SPRB-6-4P
30.....	S215-4P	12.....	S762AB-10P	12.....	S769AB-4-2P	12.....	SPRB-8-4P
30.....	S215-6P	12.....	S762AB-12P	12.....	S769AB-4-4P	12.....	SPRB-8-6P
12.....	S215-8P	24.....	S762AB-4P	12.....	S769AB-6-2P		
6.....	S224-6P	24.....	S762AB-6P	12.....	S769AB-6-4P		



# Hose & Tube Chart

## Sloan Storage Bin

- 40 bins per unit.
- Hemmed and ribbed dividers.
- Ideal for use with brass fittings.
- Base sold separately, part number 424306.
- Available with assorted brass fittings.



Base sold separately 424306.

Sloan No.	Overall Width	Overall Height	Depth
424305	33-3/4"	22-1/2"	12"
424306	35-1/2"	6"	12-1/4"

## Brass Fitting Bin Assortments

- Contains a broad selection of the most popular brass fittings.
- Each assortment has its own set of labels that includes product illustrations, size and part number.
- You receive a 424305 storage bin with each assortment purchase.



## 424302 Pipe Fitting Bin Assortment

Qty.	Sloan No.	Qty.	Sloan No.
1	424305	5	S211-8P
10	S120-4-2P	10	S215-4P
5	S120-6-4P	10	S215-6P
5	S120-8-6P	10	S215-8P
5	S202-2P	10	SPHN-4P
5	S202-4P	10	SPHN-6P
5	S202-6P	5	SPHN-8P
5	S202-8P	10	SPPH-4P
5	S203-4P	10	SPPH-6P
5	S203-6P	10	SPPH-8P
10	S207-2P	5	SPPH-12P
5	S207-4P	10	SPRB-4-2P
5	S207-6P	10	SPRB-6-4P
5	S207-8P	10	SPRB-8-4P
10	S211-4P	10	SPRB-8-6P
10	S211-6P		

## 424303 Nylon Fitting Bin Assortment

Qty.	Sloan No.	Qty.	Sloan No.
1	424305	6	S768AB-4-2P
20	S760AB-4P	6	S768AB-4-4P
20	S760AB-6P	4	S768AB-6-2P
20	S760AB-8P	6	S768AB-6-4P
10	S761AB-4P	6	S768AB-6-6P
10	S761AB-6P	4	S768AB-8-4P
8	S761AB-8P	6	S768AB-8-6P
10	S762AB-4P	6	S768AB-8-8P
8	S762AB-6P	6	S768AB-10-8P
6	S762AB-8P	6	S769AB-4-2P
4	S762AB-10P	4	S769AB-4-4P
10	S763AB-4P	6	S769AB-4-6P
10	S763AB-6P	6	S769AB-6-4P
10	S763AB-8P	6	S769AB-6-6P
10	S763AB-10P	4	S769AB-8-4P
6	S764AB-4P	6	S769AB-8-6P
6	S764AB-6P		

## 424304 Reusable Brass Fitting Bin Assortment

Qty.	Sloan No.	Qty.	Sloan No.
1	424305	10	S368AB-6-4-1
10	S360AB-6	10	S368AB-6-6-1
5	S360AB-8	10	S368AB-6-8-1
10	S361AB-6	5	S371ABS-6
10	S361AB-8	5	S371ABS-8
5	S362RB-6	10	S376AB-3/4-6
2	S362RB-8	10	S376AB-7/8-6
2	S363RB-6	2	S378AB-6-4
5	S368AB-6-4	2	S378AB-6-6
5	S368AB-6-6	2	S378AB-6-8
5	S368AB-6-8	2	S378AB-8-6
2	S368AB-8-6	2	S378AB-8-8
2	S368AB-8-8		

- Tramec
- Rubber Hose Assemblies
- Coiled Air Assemblies
- 3-in-1 & 4-in-1 Wraps
- Bulk Hose
- Air Compressor Discharge Hose Assemblies
- Quick Fix™
- Air Hose Accessories
- Hose Clamps
- Gladhands & Accessories
- Air Tanks
- Drain Valves
- Ground Plugs
- Truck Valves
- Selector Valves
- Brass Fittings
- Hose & Tube Chart**
- Dash Control Valves
- Air Brake Valves
- Air Accessory Valves
- Air Cylinders
- Switches & Toggles
- Plugs, Sockets & Cables
- RV Plugs & Sockets
- Wire & Cable
- Electrical Harnesses
- Electrical Connectors
- Fuel Caps
- Oil Caps & Dipsticks
- Grease Fittings
- Water Pumps
- Wiper Blades
- Engine Heaters
- Link Cat's Eye®
- Hub Caps, Axilok® & Securex®
- Flitz
- MAXXGreen

## Dash Control Valves

- Precision engineered and manufactured to provide optimum performance for each specified application.
- All brass construction for years of dependable, trouble-free operation.
- All units supplied without knob and roll pin except p/n 401134 & 401135.
- New construction, not remanufactured.
- Supplied with mounting nut.

### PP-1 Style Control Valve

Sloan	
No.	Description
401134	Commonly used to control parking and emergency brakes. Automatic pressure release 20 PSI. Stem diameter .377".
401135	Same as 401134 except automatic pressure release is 40 PSI.

- 401134 & 401135 come with knob and roll pin.



1/8" PT  
All Ports

### PP-2 Style Control Valve

Sloan	
No.	Description
401178	Commonly used to control parking and emergency brakes. Automatic pressure release 40 PSI. Stem diameter .377".



1/8" PT  
All Ports

### PP-5 Style Control Valve

Sloan	
No.	Description
401180	Used in conjunction with vehicle torque converter, engine speed control system, and some parking brake systems. 40 PSI release pressure.



1/8" PT  
All Ports

### PP-7 Style Trailer Supply Valve

Sloan	
No.	Description
401136	Generally used on tractors and provides modulated control on trailer brakes. Automatic pressure release 40 PSI. Stem diameter .377".
401137	Same as 401136 except with 1/4" NPTF threaded exhaust port. Stem diameter .50"



1/8" PT Supply  
1/4" PT Delivery  
1/8" PT Control

# Dash Control Valves

## PP-8 Push Pull Valve

- Pressure release at 20 psi

Sloan No.	Supply Port	Delivery Port	Exhaust Port
401209	(1) 1/8"	(2) 1/8"	(1) 1/8"



## Tractor Trailer Park Valve w/ 2-Way Check Valve

Sloan No.	Description
401029	2-Way check valve allows either primary or secondary air supply to operate spring brakes on tractor and/or trailer combinations. Stem diameter .377".
401084	Same as 401029 except with barbed fitting exhaust port for 1/2" nylon tubing.



1/4"-18 NPTF  
All Ports

## System Park Valve

Sloan No.	Description
401035	Valve is used to control spring brakes on both tractor trailer. Automatically applies when pressure drops below 35 PSI. Pull to exhaust. Push to supply. Stem diameter .377".



1/4"-18 NPTF  
All Ports  
(401035)

## Tractor Trailer Air Supply Valve

Sloan No.	Description
401032	Valve is used to control the tractor protection valve and the charge trailer system. Pull to exhaust. Push to supply. Stem diameter .314".



1/4"-18 NPTF  
All Ports

## Toggle Type Valve

Sloan No.	Description
401040	Brass constructed valve is used to control the tractor protection valve, front wheel brake limiting control and for inter-axle differential lock-out control. Chrome plated lever. Replaces Bendix TW-1. Face plate not included.



1/8"-27 NPTF  
All Ports

<b>Tramec</b>
<b>Rubber Hose Assemblies</b>
<b>Coiled Air Assemblies</b>
<b>3-in-1 &amp; 4-in-1 Wraps</b>
<b>Bulk Hose</b>
<b>Air Compressor Discharge Hose Assemblies</b>
<b>Quick Fix™</b>
<b>Air Hose Accessories</b>
<b>Hose Clamps</b>
<b>Gladhands &amp; Accessories</b>
<b>Air Tanks</b>
<b>Drain Valves</b>
<b>Ground Plugs</b>
<b>Truck Valves</b>
<b>Selector Valves</b>
<b>Brass Fittings</b>
<b>Hose &amp; Tube Chart</b>
<b>Dash Control Valves</b>
<b>Air Brake Valves</b>
<b>Air Accessory Valves</b>
<b>Air Cylinders</b>
<b>Switches &amp; Toggles</b>
<b>Plugs, Sockets &amp; Cables</b>
<b>RV Plugs &amp; Sockets</b>
<b>Wire &amp; Cable</b>
<b>Electrical Harnesses</b>
<b>Electrical Connectors</b>
<b>Fuel Caps</b>
<b>Oil Caps &amp; Dipsticks</b>
<b>Grease Fittings</b>
<b>Water Pumps</b>
<b>Wiper Blades</b>
<b>Engine Heaters</b>
<b>Link Cat's Eye®</b>
<b>Hub Caps, Axilok® &amp; Securex®</b>
<b>Flitz</b>
<b>MAXXGreen</b>

# Dash Control Valves

Air Products

## MV-3 Dash Valve

- Genuine Bendix

Sloan	
No.	Description
401233	Combination PP1 & PP7



## MV-2 Dash Valve

- One piece construction

Sloan	
No.	Description
401232	1/4" unthreaded mounting holes



## Dash Control Valves

- Fits standard 22mm x 44mm openings
- 150 psi maximum pressure
- DOT approved push-to-connect fittings included

Sloan	
No.	Description
401244	Inter-Axle differential lock
401245	Fifth wheel slide
401246	Air suspension dump
401247	Power take off
401248	Air intake
401250	Universal
401252	EZ exit



401244



401245



401246



401247



401248



401250



401252

# Dash Control Valves



## Dash Control Valve Knobs

- Includes roll pin for mounting

Sloan No.	Legend	Color	Mtg. Hole	
			Dia.	Application
401705	Two Speed Axle Face Plate	Silver	(2) .22"	401040
401708	Trailer Air Supply	Red	.316"	401032, 401137
401710	System Park	Yellow	.379"	401029, 401035, 401082, 401084, 401134, 401135, 401136
401712	Tractor Park	Blue	.316"	401032, 401137
401714	Parking Brake	Yellow	.379"	401029, 401035, 401082, 401084, 401134, 401135, 401136
401716	Trailer Emergency	Red	.316"	401032, 401137
401725	7/8"-20 Jam Nut	---	---	All Sloan Dash Valves
401727	Parking Brake	Yellow	1/4"-28 thread	---



Part No.  
401705



Part No.  
401708



Part No.  
401710



Part No.  
401712



Part No.  
401714



Part No.  
401716



Part No.  
401725



Part No.  
401727  
(Female Thread)

## Dash Control Valve Repair Kit

- Repairs all Sloan brass dash control valves
- Not intended for PP-1 and PP-7 Bendix style valves
- Includes o-ring, washer, seals, nut and instructions

Sloan No.	Application
401039	401029, 401032, 401035, 401082, 401084

### Tramec

#### Rubber Hose Assemblies

#### Coiled Air Assemblies

#### 3-in-1 & 4-in-1 Wraps

#### Bulk Hose

#### Air Compressor Discharge Hose Assemblies

#### Quick Fix™

#### Air Hose Accessories

#### Hose Clamps

#### Gladhands & Accessories

#### Air Tanks

#### Drain Valves

#### Ground Plugs

#### Truck Valves

#### Selector Valves

#### Brass Fittings

#### Hose & Tube Chart

#### Dash Control Valves

#### Air Brake Valves

#### Air Accessory Valves

#### Air Cylinders

#### Switches & Toggles

#### Plugs, Sockets & Cables

#### RV Plugs & Sockets

#### Wire & Cable

#### Electrical Harnesses

#### Electrical Connectors

#### Fuel Caps

#### Oil Caps & Dipsticks

#### Grease Fittings

#### Water Pumps

#### Wiper Blades

#### Engine Heaters

#### Link Cat's Eye®

#### Hub Caps, Axilok® & Securex®

#### Flitz

#### MAXXGreen

## Check Valves

- Precision engineered and manufactured to provide optimum performance for each specified application.
- All brass construction (except as noted) for years of dependable, trouble-free operation.

### One-Way Check Valve

Sloan No.	A	B
401008	3/8-18 NPTF	3/8-18 NPTF
401009	1/2-14 NPTF	1/2-14 NPTF
401167*	3/8-18 NPTF	3/8-18 NPTF
401166*	1/2-14 NPTF	1/2-14 NPTF

\*Constructed from steel



### Low Profile One-Way Check Valve

Sloan No.	A	B
401011	3/8-18 NPTF	1-1/16 UN2A
401012	3/8-18 NPTF	3/4-14 NPTF

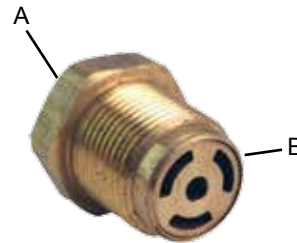

### 90° One-Way Check Valve

Sloan No.	*A	B
401017	1/2-14 PTF	1/2-14 PTF

\* With thread sealant.

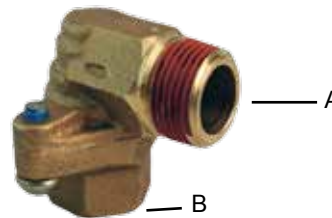

### "Z" Type One-Way Check Valve

Sloan No.	A	B
401018	1/2-14 NPTF	1/2-14 NPTF



### Two-Way Check Valve

Sloan No.	A	B	C	D
401019	3/8-18 NPTF	1/2-14 NPTF	3/8-18 NPTF	3/8-18 NPSF
401171	3/8-18 NPTF	3/8-18 NPTF	---	3/8-18 NPSF

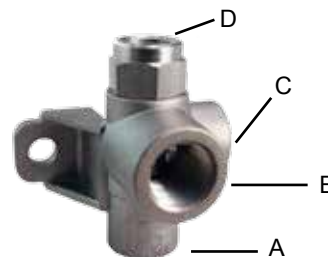

# Air Brake Valves



## Pressure Protection Valve PR-2 Style

- Replaces BENDIX PR-2

Sloan			
No.	Supply	Delivery	PSI
401286	1/4"	1/4"	65
401287	1/4"	1/4"	85



## Pressure Protection Valve PR-4 Style

- Replaces BENDIX PR-4.

Sloan			
No.	Supply	Delivery	PSI
401181	1/4"	1/4"	85
401288	1/4"	1/4"	85



## Pressure Protection Valve

Sloan	
No.	Description
401207	2 1/4" Ports, 150 max psi, normally closed



## TP-3 Tractor Protection Valve

Sloan No.	Service Tractor Port	Service Trailer Port	Emerg. Tractor Port	Emerg. Trailer Port
401228	(1) 3/8"	(1) 1/2"	(1) 1/4"	(1) 1/2"



Tramec
Rubber Hose Assemblies
Coiled Air Assemblies
3-in-1 & 4-in-1 Wraps
Bulk Hose
Air Compressor Discharge Hose Assemblies
Quick Fix™
Air Hose Accessories
Hose Clamps
Gladhands & Accessories
Air Tanks
Drain Valves
Ground Plugs
Truck Valves
Selector Valves
Brass Fittings
Hose & Tube Chart
Dash Control Valves
<b>Air Brake Valves</b>
Air Accessory Valves
Air Cylinders
Switches & Toggles
Plugs, Sockets & Cables
RV Plugs & Sockets
Wire & Cable
Electrical Harnesses
Electrical Connectors
Fuel Caps
Oil Caps & Dipsticks
Grease Fittings
Water Pumps
Wiper Blades
Engine Heaters
Link Cat's Eye®
Hub Caps, Axilok® & Securex®
Flitz
MAXXGreen



## ST-3 Safety Valve

Sloan	
No.	Description
401206	150 psi cracking pressure



## LQ-4 Front Axle Quick Release Valve

- 60 psi equalizing pressure

Sloan No.	Supply Port	Delivery Port
401212	(1) 3/8"	(1) 3/8"



## QR-1C Quick Release Valve

- Replaces Bendix QR-1C quick release valve
- Used wherever a quick release function is required in the air brake system
- Aids in meeting FMVSS-121 timing requirements

Sloan		
No.	Supply	Delivery
401279*	1/4"	3/8"

\*Item has (1) 1/4" balance port.



## Quick Release Valve

- Replaces Bendix QR-1 quick release valve
- Used wherever a quick release function is required in the air brake system
- Aids in meeting FMVSS-121 timing requirements

Sloan No.	Supply	Delivery	Exhaust	Crack Pressure
401143	3/8"	(2) 3/8	3/8	1.0 PSI
401144	1/2"	(2) 3/8	3/8	1.0 PSI
401280	3/8"	(2) 1/4"	3/8 - No Thread	1.0 PSI



## Inline Quick Release Valve

- Rapidly releases air pressure from trailer brake lines.
- Faster release of trailer service brakes when installed on service side gladhand.
- Quicker application of trailer service brakes when installed on the emergency side gladhand.
- Can be used on double and triple trailers.
- Measures 1.5" diameter x 3.5" long.
- Flow Rate:  
Forward - 9.0 SCFM at 2 PSI  
Exhaust - 8.0 SCFM at 2 PSI

Sloan			
No.	Tractor	Trailer	Description
401145	1/2-14 FPT	1/2-14 MPT	Mounts between tractor protection valve and air lines
401146	1/2-14 FPT	1/2-14 MPT	Mounts at tractor gladhand



401145



401146

# Air Brake Valves

## D-2 Air Governor

Working in conjunction with the compressor unloader valve, the governor controls air pressure in the supply system automatically by maintaining the level of air between the adjustable opening and closing preset pressure settings.

- Replaces Bendix D2, Midland KN18530 and other popular air governors.
- Can be remote or compressor mounted.
- Manually adjustable opening and closing settings.
- Internal ball check and filtered ports help reduce contamination.
- 150 psi maximum operating pressure.
- Includes mounting gasket and (4) 1/8" socket head pipe plugs.
- Mounting holes on 1-1/8" centers.
- 401237 is a high temperature governor w/ high temp o-rings and waterproof cover.

Sloan No.	Port Size	Cut In Press.	Cut Out Press.
401142•	1/8" NPT	90-105	125+-5
401237	1/8" PT	90-105	125+-5

•Indicates item is available as 25 pieces in one box. Order part number with suffix -25.



## E-3 Foot Valve

Sloan No.	Supply Port	Delivery Port	Aux. Sup. Port
401213	(2) 1/2"	(4) 1/2"	(2) 1/4"



## EP-8 Foot Valve

- Replaces Bendix E-8P foot Valve.
- Lower Body Rated.

Sloan No.	Supply Port	Delivery Port	Aux. Sup. Port
401275	(2) 3/8"	(4) 3/8"	(1) 3/8"



## SR-1 Spring Brake Valve

- Back mounted
- 90-95 psi limiting pressure

Sloan No.	Supply Port	Delivery Port	Exhaust Port	Reservoir Port
401211	1/4"	1/4"	1/4"	1/4"



- Tramec
- Rubber Hose Assemblies
- Coiled Air Assemblies
- 3-in-1 & 4-in-1 Wraps
- Bulk Hose
- Air Compressor Discharge Hose Assemblies
- Quick Fix™
- Air Hose Accessories
- Hose Clamps
- Gladhands & Accessories
- Air Tanks
- Drain Valves
- Ground Plugs
- Truck Valves
- Selector Valves
- Brass Fittings
- Hose & Tube Chart
- Dash Control Valves
- Air Brake Valves**
- Air Accessory Valves
- Air Cylinders
- Switches & Toggles
- Plugs, Sockets & Cables
- RV Plugs & Sockets
- Wire & Cable
- Electrical Harnesses
- Electrical Connectors
- Fuel Caps
- Oil Caps & Dipsticks
- Grease Fittings
- Water Pumps
- Wiper Blades
- Engine Heaters
- Link Cat's Eye®
- Hub Caps, Axilok® & Securex®
- Flitz
- MAXXGreen

## E-6 Dual Brake Valve

- Replaces Bendix E-6 dual brake valve.
- Meets FMVSS-121 requirements.

Sloan No.	Supply		Delivery	
	#1	#2	#1	#2
401133	(2) 3/8" PT	(2) 3/8" PT	(2) 3/8" PT	(2) 3/8" PT



## E-7 Brake Valve

- Replaces Bendix E-7 dual brake valve.
- Meets FMVSS-121 requirements.

Sloan No.	Supply		Delivery	
	#1	#2	#1	#2
401176	(2) *	1/4"	(2) *	1/4"
401177	(2) 1/4" (2) 1/2"***	(2) 1/4"*	(2) 3/8" (2) 1/2"***	(2) 3/8"*



\* O-Ring sealed flange ports  
\*\* Ports on mounting side

## Relay Valve

- 4-5 psi cracking pressure

Sloan No.	Supply Port	Delivery Port	Control Port
401220	(2) 1/2"	(2) 3/8"	(1) 3/8"



## RE-6 Relay Valve

- Replaces Bendix RE-6 relay valve.
- 4 port delivery.
- Dual function valve used on trailers.
- Used on pre-FMVSS-121 vehicles and off road applications.

Sloan No.	Supply	Delivery	Service	Emergency	Intl. Emer. Appl. Pres.	Max. Emer. Rel. Pres.
401130	3/8" PT	(2) 3/8" PT (2) 1/4" PT	1/4" PT	---	5±5 PSI	95 PSI



## R-6 Relay Valve

- Replaces Bendix R-6 relay valve.
- 4 port delivery.
- 180° service port

Sloan No.	Supply	Delivery	Control	Crack Pressure
401131	3/8" PT	(4) 3/8" PT	1/4" PT	2.0 PSI



# Air Brake Valves

## R-8 Relay Valve

Sloan No.	Supply Port	Delivery Port	Service Port
401210	(2) 3/4"	(2) 1/2"	(1) 1/4"



## R-12 Relay Valve

- Replaces Bendix R-12 Relay Valve.
- Vertical mount.
- 4 port delivery located on the bottom of the valve.
- Includes universal mounting bracket.

Sloan No.	Supply	Delivery	Control	Crack Pressure
401132	1/2" PT	(4) 1/2" PT	1/4" PT	4.0 PSI



## R-12P Relay Valve

- Replaces Bendix R-12P Relay Valve.
- Vertical mount.
- 2 port delivery located on the side of the valve.

Sloan No.	Supply	Delivery	Control	Crack Pressure
401274	(2) 1/2" PT	(2) 3/8" PT	1/4" PT	4.0 PSI



## R-12H Relay Valve

- Replaces Bendix R-12H Relay Valve.
- Horizontal mount.
- 2 port delivery located on the side of the valve.

Sloan No.	Supply	Delivery	Control	Crack Pressure
401168	(2) 3/4" PT	(2) 1/2" PT	1/4" PT	4.0 PSI



## R-14 Relay Valve

- Replaces Bendix R-14 Relay Valve.
- Vertical mount.
- 4 port delivery.
- Controls spring brakes and service brakes.

Sloan No.	Supply	Delivery	Control	Crack Pressure
401170	1/2" PT	(4) 1/2" PT	1/4" PT	4.0 PSI



Tramec
Rubber Hose Assemblies
Coiled Air Assemblies
3-in-1 & 4-in-1 Wraps
Bulk Hose
Air Compressor Discharge Hose Assemblies
Quick Fix™
Air Hose Accessories
Hose Clamps
Gladhands & Accessories
Air Tanks
Drain Valves
Ground Plugs
Truck Valves
Selector Valves
Brass Fittings
Hose & Tube Chart
Dash Control Valves
<b>Air Brake Valves</b>
Air Accessory Valves
Air Cylinders
Switches & Toggles
Plugs, Sockets & Cables
RV Plugs & Sockets
Wire & Cable
Electrical Harnesses
Electrical Connectors
Fuel Caps
Oil Caps & Dipsticks
Grease Fittings
Water Pumps
Wiper Blades
Engine Heaters
Link Cat's Eye®
Hub Caps, Axilok® & Securex®
Flitz
MAXXGreen

## R-14H Relay Valve

- Replaces Bendix R-14H Relay Valve.
- Horizontal mount.
- 2 port delivery.
- Controls spring brakes and service brakes.
- 1/8" balance port located under the exhaust cover.



Sloan No.	Supply	Delivery	Control	Crack Pressure
401169	(2) 3/4" PT	(2) 1/2" PT	1/4" PT	4.0 PSI

## RG2 Relay Valve

- Replaces Midland RG2 Relay Valve.
- Used to apply and release service brakes on tractor or trailer.
- 2 port delivery.



Sloan No.	Supply	Delivery	Control	Crack Pressure
401201	(2) 3/8" PT	(2) 3/8" PT	1/4" PT	5.5 PSI
401202	(1) 1/2" PT (1) 3/8" PT	(2) 3/8" PT	1/4" PT	5.5 PSI
401182	(2) 1/2" PT	(2) 1/2" PT	1/4" PT	5.5 PSI

## Relay Emergency Valve

Sloan No.	Supply Port	Delivery Port	Control Port	Emerg. Supply Port
401226	(1) 1/2"	(4) 1/4"	(2) 1/4"	(1) 1/4"



## Relay Emergency Valve

- Charging type
- 4.5 psi cracking pressure

Sloan No.	Supply Port	Delivery Port	Service Port	Emerg. Supply Port
401227	(1) 3/4"	(4) 3/8"	(1) 1/4"	(1) 1/4"



## Relay Emergency Valve

- With ratio feature
- Crack pressure 4.5 psi

Sloan No.	Supply Port	Tank Port	Service Port	Emerg. Supply Port
401229	(4) 3/8"	(1) 3/4"	(2) 1/4"	(1) 1/4"



# Air Brake Valves

## TP-5 Tractor Protection Valve

Sloan	
No.	Description
401234	Replaces control valve manifold

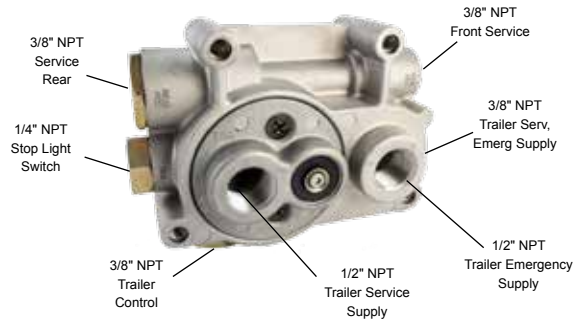

## BP-R1 Bobtail Proportioning Valves

- With mounting bracket
- 401235 4 psi crack pressure
- 401236 5.5 psi crack pressure

Sloan No.	Supply Port	Delivery Port	Service Port	Control Port
401235	(1) 1/2"	(4) 3/8"	(1) 1/4"	(1) 1/8"
401236	(1) 1/2"	(4) 3/8"	(1) 1/4"	(1) 1/8"



## Automatic Non-heated Drain Valve

Sloan		
No.	Inlet	Outlet
401269	1/4"	1/4"



## Automatic Heated Drain Valve

- 12 Volt - 5 Amp

Sloan		
No.	Inlet	Outlet
401270	1/4"	1/4"



## DV-2 Automatic Drain Valve

Sloan	
No.	Description
401216	Inlet & Outlet 1/4" each



- Tramec
- Rubber Hose Assemblies
- Coiled Air Assemblies
- 3-in-1 & 4-in-1 Wraps
- Bulk Hose
- Air Compressor Discharge Hose Assemblies
- Quick Fix™
- Air Hose Accessories
- Hose Clamps
- Gladhands & Accessories
- Air Tanks
- Drain Valves
- Ground Plugs
- Truck Valves
- Selector Valves
- Brass Fittings
- Hose & Tube Chart
- Dash Control Valves
- Air Brake Valves**
- Air Accessory Valves
- Air Cylinders
- Switches & Toggles
- Plugs, Sockets & Cables
- RV Plugs & Sockets
- Wire & Cable
- Electrical Harnesses
- Electrical Connectors
- Fuel Caps
- Oil Caps & Dipsticks
- Grease Fittings
- Water Pumps
- Wiper Blades
- Engine Heaters
- Link Cat's Eye®
- Hub Caps, Axilok® & Securex®
- Flitz
- MAXXGreen

## Trailer Spring Brake Valves (SR2, SR4, and SR5 Styles)

- Replaces Bendix style trailer spring brake valves.
- Meets FMVSS-121 requirements.
- SR2/5 valves are used on trailers with dual air brake systems.
- SR4 valves are used on trailers to control both parking and emerg. brake functions.

### SR2 Valve

Sloan No.	Supply	Delivery	Reservoir	Exhaust	Service
401183	1/4"	(4) 3/8"	3/4"	3/8"	1/4"
401184	1/4"	(4) 3/8"	3/4"	3/8"	(2) 1/4"
401185	1/4"	(4) 3/8"	1/2"	3/8"	1/4"



### SR4 Valve

Sloan No.	Supply	Delivery	Reservoir	Res. Service	Male Port
401186	1/4"	(4) 3/8" 1/4"	3/4"	1/4"	3/4"
401187	1/4"	(4) 3/8" 1/4"	3/4"	1/4"	1/2"



### SR5 Valve

Sloan No.	Supply	Delivery	Reservoir	Service
401188	1/4"	(4) 3/8"	3/4"	(2) 1/4"
401189	1/4"	(4) 3/8"	1/2"	(2) 1/4"



### Transmission Valve

- Replaces Eaton/Fuller A3546

Sloan No.	Supply Port	Delivery Port
401292	1/8"	1/8"



# Air Brake Valves

## Purge Valve

- Replaces Bendix AD-9

Sloan	
No.	Voltage
401271	12V
401272	24V



## 3-Way Pilot Valve

- Replaces Neway 9054079

Sloan	
No.	Port
401284	1/4"



## Air Regulating Valve

Sloan No.	Supply Port	Delivery Port	Output
401285	3/8"	3/8"	10-125 psi



## Limiting Valve

- Replaces Bendix LQ-2 Limiting Valve

Sloan No.	Supply Port	Delivery Port	Exhaust Port
401281	3/8"	3/8"	-
401282	1/2"	1/4"	-
401283	3/8"	1/4"	3/8"



## Air Shift Valve

- Replaces Eaton/Fuller A4041

Sloan No.	Supply Port	Delivery Port
401293	1/4"	1/4"



- Tramec
- Rubber Hose Assemblies
- Coiled Air Assemblies
- 3-in-1 & 4-in-1 Wraps
- Bulk Hose
- Air Compressor Discharge Hose Assemblies
- Quick Fix™
- Air Hose Accessories
- Hose Clamps
- Gladhands & Accessories
- Air Tanks
- Drain Valves
- Ground Plugs
- Truck Valves
- Selector Valves
- Brass Fittings
- Hose & Tube Chart
- Dash Control Valves
- Air Brake Valves**
- Air Accessory Valves
- Air Cylinders
- Switches & Toggles
- Plugs, Sockets & Cables
- RV Plugs & Sockets
- Wire & Cable
- Electrical Harnesses
- Electrical Connectors
- Fuel Caps
- Oil Caps & Dipsticks
- Grease Fittings
- Water Pumps
- Wiper Blades
- Engine Heaters
- Link Cat's Eye®
- Hub Caps, Axilok® & Securex®
- Flitz
- MAXXGreen



## Governor

- Unloaded and Regular Valve

Sloan		
No.	Inlet	Outlet
401268	22 mm	22 mm



## RT-4 Multifunction Trailer Valve

- 55 psi closing pressure

Sloan No.	Supply Port	Delivery Port	Control Port	Reservoir Port	Reservoir Port
401223	(2) 3/8"	(4) 3/8"	(1) 3/8"	(1) 1/2"	(1) 3/8"



## FF-2 Full Function Valve

- 3 psi cracking pressure

Sloan No.	Supply Port	Control Port	Reservoir Port	Service Brake Port	Spring Brake Port
401221	(1) 3/8"	(1) 1/4"	(1) 3/4"	(4) 3/8"	(2) 3/8"
401222	(1) 3/8"	(1) 1/4"	(1) 1/2"	(4) 3/8"	(2) 3/8"



## Height Control Leveling Valve

Sloan		
No.	Porting	Delay
401224	All ports 1/4"	4 seconds

Comes with installation hardware



## Height Control Leveling Valve

Sloan		
No.	Porting	Delay
401225	All ports 1/8"	6 seconds

Comes with installation hardware

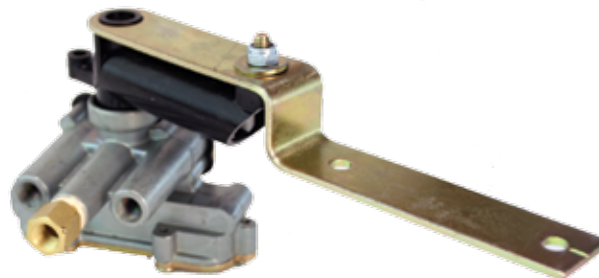

# Air Brake Valves



## Transmission Selector Valves

Sloan No.	Port Size	Replaces
401289	1/16"	Eaton/Fuller A4487
401290	1/16"	Eaton/Fuller A4490
401291	1/16"	Eaton/Fuller A4491



## Ergonomic Transmission Air Shift Valves

Sloan No.	Porting	Replaces
401297	1/16"	Eaton/Fuller A6913, A4900



## Ergonomic Transmission Air Shift Valves

Sloan No.	Porting	Replaces
401299	1/16"	Eaton/Fuller A6909, A5010



## Ergonomic Transmission Air Shift Valves

Sloan No.	Porting	Replaces
401301	1/16"	Eaton/Fuller A6915, A5015



## Ergonomic Transmission Air Shift Valves

Sloan No.	Porting	Replaces
401303	1/16"	Eaton/Fuller A6918



- Tramec
- Rubber Hose Assemblies
- Coiled Air Assemblies
- 3-in-1 & 4-in-1 Wraps
- Bulk Hose
- Air Compressor Discharge Hose Assemblies
- Quick Fix™
- Air Hose Accessories
- Hose Clamps
- Gladhands & Accessories
- Air Tanks
- Drain Valves
- Ground Plugs
- Truck Valves
- Selector Valves
- Brass Fittings
- Hose & Tube Chart
- Dash Control Valves
- Air Brake Valves**
- Air Accessory Valves
- Air Cylinders
- Switches & Toggles
- Plugs, Sockets & Cables
- RV Plugs & Sockets
- Wire & Cable
- Electrical Harnesses
- Electrical Connectors
- Fuel Caps
- Oil Caps & Dipsticks
- Grease Fittings
- Water Pumps
- Wiper Blades
- Engine Heaters
- Link Cat's Eye®
- Hub Caps, Axilok® & Securex®
- Flitz
- MAXXGreen

## Lift Axle Control Module

Media	Compressed Dry Air
Media Preparation Required	Filtered to 40 Microns
Pressure Range	45-150 psi
Temperature Range	-40 to +140°F
Cv	1.2
Supply Ports	DOT 3/8" Push to Connect
Lift/Ride Ports	
Exhaust Port	
<b>Electrical</b>	
Voltage	12 VDC
Voltage Tolerance	-25% / +34% (9 VDC - 16VDC)
Power	2.5 W
Wiring	500mm Flying Leads
<b>Materials</b>	
Body	Aluminum - Anodized
Spools	Aluminum
Seals	Low Temperature Buna N
Springs	Stainless Steel
Regulator/Valves	Various - Thermoplastics
Face Plates	Aluminum - Anodized
Cabinet (Outside only)	Stainless Steel

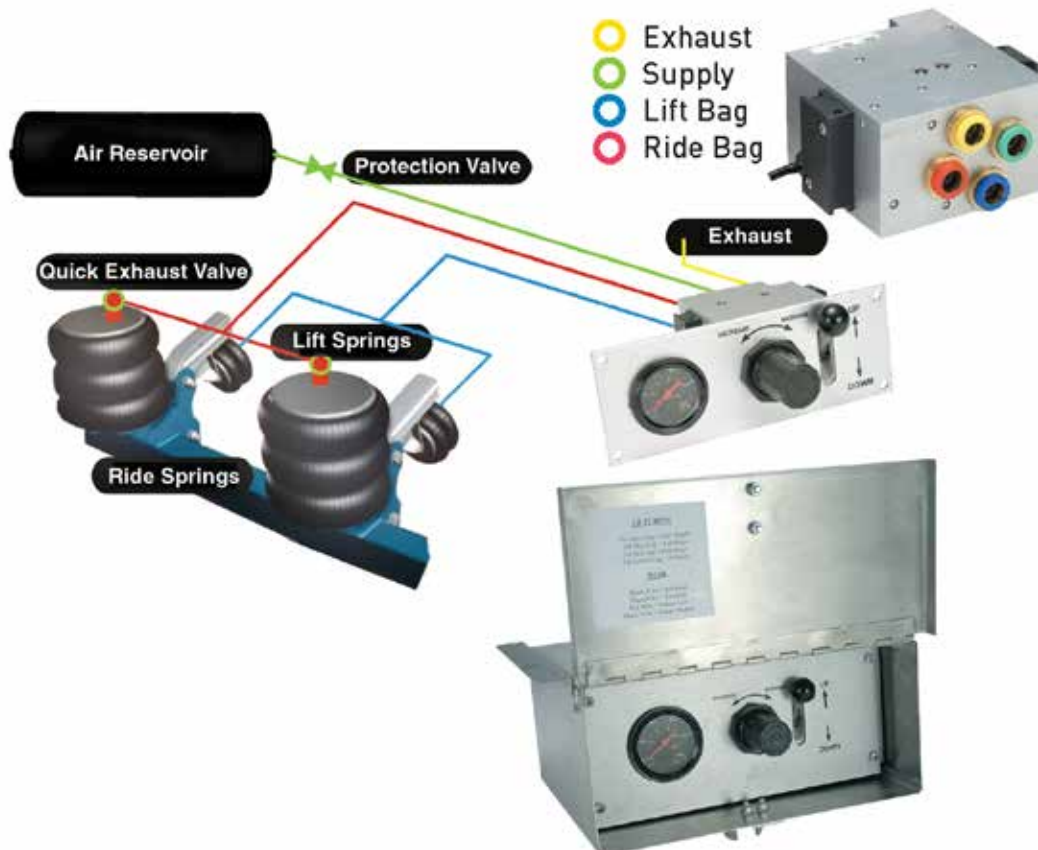

# Air Accessory Valves



## Single Axle/Inside

•Replaces Hendrickson HLK Series

Sloan No.	Hendrickson No.	Description	PSI
401328	004301	Steerable	3/8" DOT PTC
401329	004307	Reverse	3/8" DOT PTC
401330	004319	Non Steerable	3/8" DOT PTC



## Single Axle/Outside

•Replaces Hendrickson HLK Series  
•Inside lift and lock module shown

Sloan No.	Hendrickson No.	Description	PSI
401331	004323	Steerable	3/8" DOT PTC
401332	004468	Reverse	3/8" DOT PTC
401333	004325	Non Steerable	3/8" DOT PTC



## Single Axle/Lift and Lock

•Replaces Hendrickson HLK Series

Sloan No.	Hendrickson No.	Description	PSI
401334	005446	Inside	3/8" DOT PTC
401335	006013	Outside	3/8" DOT PTC



## Replacement Axle Control Module

•For use with all lift axle modules  
•Toggle switch knob not included

Sloan No.	Hendrickson No.	Description	PSI
401336	004558	Control Module	3/8" DOT PTC

- Tramec
- Rubber Hose Assemblies
- Coiled Air Assemblies
- 3-in-1 & 4-in-1 Wraps
- Bulk Hose
- Air Compressor Discharge Hose Assemblies
- Quick Fix™
- Air Hose Accessories
- Hose Clamps
- Gladhands & Accessories
- Air Tanks
- Drain Valves
- Ground Plugs
- Truck Valves
- Selector Valves
- Brass Fittings
- Hose & Tube Chart
- Dash Control Valves
- Air Brake Valves
- Air Accessory Valves
- Air Cylinders
- Switches & Toggles
- Plugs, Sockets & Cables
- RV Plugs & Sockets
- Wire & Cable
- Electrical Harnesses
- Electrical Connectors
- Fuel Caps
- Oil Caps & Dipsticks
- Grease Fittings
- Water Pumps
- Wiper Blades
- Engine Heaters
- Link Cat's Eye®
- Hub Caps, Axilok® & Securex®
- Flitz
- MAXXGreen

## Lift Axle Module Accessories

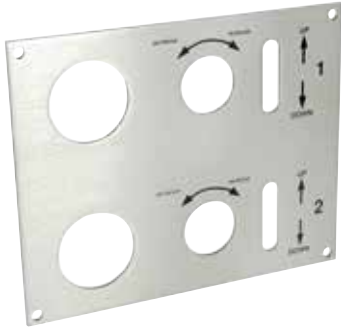

### Replacement Panels

•Double Panel Shown

Sloan No.	Hendrickson No.	Description
401337	004334	Single
401338	004335	Double
401339	004336	Triple



### Pressure Gauges

•For use with all lift axle modules

Sloan No.	Hendrickson No.	Description
401340*	AM-1.5-150	Gauge
401341**	AM-2.0-150MMPM	Gauge
401342	ACCBULBWIRE12VDC	Bulb

\*For use with inside model - 401328, 401329, 401330

\*\* For use with outside model - 401331, 401332, 401333



### Toggle Switch

•For use with all lift axle modules

Sloan No.	Hendrickson No.	Description
401343	332-1034	Toggle Switch Lever
401344	RS#686014	Toggle Switch Knob



### Valve Assembly

•For use with lift and lock modules

Sloan No.	Hendrickson No.	Description
401345	004378APH	Valve Assembly



### Solenoid Valve

•12 VDC

Sloan No.	Hendrickson No.	Description
401346	KVA011047D012	For use with all other models
401347	0131111F01104712	For use with model 401333 only

# Air Accessory Valves



## Lift Axle Control Module

The Sloan Lift Axle Control Module is supplied ready for installation. It is designed to control the raising and lowering of a lift axle by inflating and deflating the air bags all done electronically. The module incorporates a 4-way valve, regulator, DOT cartridge push-in fittings, automatic solenoid, and air gauge.

- Designed to reduce assembly time and errors current lift axle circuitries present.
- Reduces use of parts by 50% compared to current lift axle circuitries.
- Protected exhaust ports.
- DOT Cartridge push-in fittings.
- Temperature rating of -40°F to 160°F.
- SAE J1128 and IP65 compliant.
- Solenoid rated for 9-16 VDC

Sloan No.	Description
401138	Axle normally down - w/gauge
401139	Axle normally down - w/o gauge
401140*	Axle normally up - w/gauge
401141*	Axle normally up - w/o gauge
401777	Replacement solenoid
401778	Replacement gauge

\* Both solenoid and regulator are on the left side

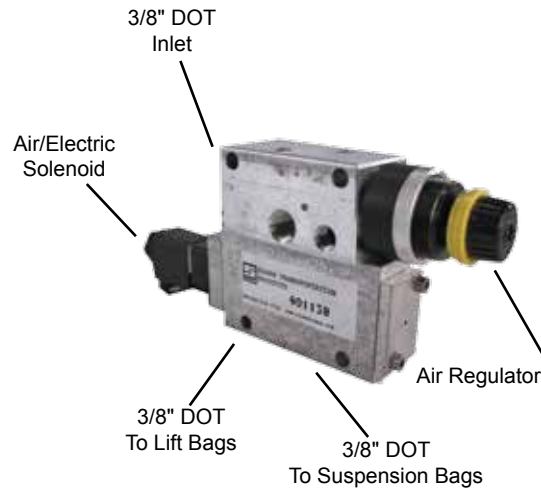

401777

\*See pages 258 and 259 for installation diagrams\*

## Pressure Protection Valves

- Protects primary air source against loss of air pressure downstream.
- Designed for in-tank mounting on tanks with dual outlet ports.



Sloan No.	Inlet Ports	Outlet Ports	Nom. Opening Pressure	Nom. Closing Pressure
401152	3/8 NPTM	3/8 NPTF	55 PSI	45 PSI
401153	3/8 NPTM	3/8 NPTF	85 PSI	67 PSI
401154	3/8 NPTM	1/2 NPTF	55 PSI	45 PSI
401155	3/8 NPTM	1/2 NPTF	85 PSI	67 PSI
401156	1/4 NPTM	1/2 NPTF	100 (max) PSI	70 (min) PSI

- Tramec**
- Rubber Hose Assemblies**
- Coiled Air Assemblies**
- 3-in-1 & 4-in-1 Wraps**
- Bulk Hose**
- Air Compressor Discharge Hose Assemblies**
- Quick Fix™**
- Air Hose Accessories**
- Hose Clamps**
- Gladhands & Accessories**
- Air Tanks**
- Drain Valves**
- Ground Plugs**
- Truck Valves**
- Selector Valves**
- Brass Fittings**
- Hose & Tube Chart**
- Dash Control Valves**
- Air Brake Valves**
- Air Accessory Valves**
- Air Cylinders**
- Switches & Toggles**
- Plugs, Sockets & Cables**
- RV Plugs & Sockets**
- Wire & Cable**
- Electrical Harnesses**
- Electrical Connectors**
- Fuel Caps**
- Oil Caps & Dipsticks**
- Grease Fittings**
- Water Pumps**
- Wiper Blades**
- Engine Heaters**
- Link Cat's Eye®**
- Hub Caps, Axilok® & Securex®**
- Flitz**
- MAXXGreen**

## Rapid Dump Air Suspension Valve

- Replaces Bendix TR-3, SV-1 and Humphrey 250A N/O valves.
- Pilot operated.
- Rapidly exhausts air from suspension air springs.
- Mounts on frame rails using 1/4" mounting holes.
- Dual delivery design allows for convenient in-line plumbing of air spring lines and eliminates need for tee fittings.



Sloan No.	Port Size	Mtg. Hole Dia.
401148	(4) 1/8 FPT	1/4

## Air/Air-Electric Toggle/Flipper Valves

- Used for a variety of air and air-electric applications such as air suspensions, lift axles, fifth wheel sliders and differential locks.
- Push-connect fittings mate easily with 1/4" nylon tubing.
- 150 PSI max. operating pressure.
- Includes all necessary mounting hardware.
- Air-electric switches include a pressure switch and terminals for indicator lamps.
- Switch Off Position: No air flow, electrical contacts open.
- Switch On Position: Air flows through valve, electrical contacts closed.
- Pressure Switch: Open below 10 PSI, closed above 35 PSI.
- Amperage: 5 amp resistive current load at 12 VDC.
- Terminal Size: 1/4" blade.

### Air/Air-Electric Toggle Valve

Sloan No.	Description	Toggle Type
401157	Air-Electric 3-way toggle valve	Paddle
401158	Air-Electric 3-way toggle valve	Blade
401159	Air-Electric 3-way toggle valve	Bat
401160	Air 3-way toggle valve	Paddle
401161	Air 3-way toggle valve	Blade
401311	Air/Air Electrical	Bat



401157



401158



401159



401160



401161



401311

### Air/Air-Electric Flipper Valve

Sloan No.	Description	Lever Position
401162	Air-Electric 3-way flipper valve	On - Off - Exhaust
401163	Air 3-way flipper valve	On - Off - Exhaust



401162



401163

# Air Accessory Valves

## Air Horn Valves

Sloan No.	Ports	Application
401164	(2) 1/4"	Kenworth
401165	(2) 3/8"	Navistar
401253	(3) 1/4"	Kenworth
401254	(3) 1/4", (1) 3/8"	Freightliner - Dual Outlet
401255	(3) 1/4", (1) 3/8"	Freightliner
401256	(2) 3/8"	Navistar
401257	(2) 3/8"	Navistar
401308	STD	Bendix



401165



401257



401256



401253



401164



401255



401254

- Tramec
- Rubber Hose Assemblies
- Coiled Air Assemblies
- 3-in-1 & 4-in-1 Wraps
- Bulk Hose
- Air Compressor Discharge Hose Assemblies
- Quick Fix™
- Air Hose Accessories
- Hose Clamps
- Gladhands & Accessories
- Air Tanks
- Drain Valves
- Ground Plugs
- Truck Valves
- Selector Valves
- Brass Fittings
- Hose & Tube Chart
- Dash Control Valves
- Air Brake Valves
- Air Accessory Valves
- Air Cylinders
- Switches & Toggles
- Plugs, Sockets & Cables
- RV Plugs & Sockets
- Wire & Cable
- Electrical Harnesses
- Electrical Connectors
- Fuel Caps
- Oil Caps & Dipsticks
- Grease Fittings
- Water Pumps
- Wiper Blades
- Engine Heaters
- Link Cat's Eye®
- Hub Caps, Axilok® & Securex®
- Flitz
- MAXXGreen



## Height/Lumbar Control Seat Valves

- Controls air ride truck seats and lumbar supports.
- Electro-pneumatic combination valve designed to operate air seats using an electric air compressor.
- Spring-loaded, three way function.



401147



401150



401149



401151

Sloan No.	Description	Port Size
401147	End and side ported with removable chrome knob	(2) 1/8 FPT
401149	Paddle Type	(2) 3/16 barb
401150	End ported with removable chrome knob	(2) 1/8 FPT
401151	Electro-Pneumatic with removable black knob and two 1/4" blade terminals	(1) 1/8 FPT

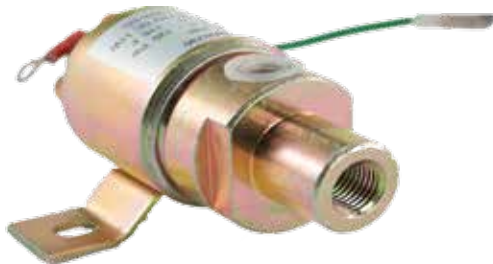

## Three-Way Solenoid Valve

- 12 VDC
- On/off exhaust function
- Inlet port normally closed

Sloan No.	Port Size	Operating Pressure
401190	(2) 1/4 FPT	100-120 PSI



## Filter Assembly

- Replaces Eaton/Fuller A4740

Sloan No.	Supply Port	Delivery Port	PSI
401304	(1) 3/8"	(3) 1/8"	55-65 psi

# Air Accessory Valves



## Filter Regulator Kit

- Replaces Eaton/Fuller K2170

Sloan No.	Supply Port	Delivery Port	PSI
401305	(1) 1/8"	(3) 1/8"	57-65 psi

- Plug bottom for A-5161



## Pressure Regulator

- Replaces Eaton/Fuller 16743

Sloan No.	Supply Port	Delivery Port	PSI
401306	1/4"	1/8"	55-65 psi



## Pressure Regulator

- Replaces Meritor/Rockwell A-3280-9072

Sloan No.	Supply Port	Delivery Port	PSI
401307	(1) 3/8"	(3) 1/8"	55-70 psi

- Tramec
- Rubber Hose Assemblies
- Coiled Air Assemblies
- 3-in-1 & 4-in-1 Wraps
- Bulk Hose
- Air Compressor Discharge Hose Assemblies
- Quick Fix™
- Air Hose Accessories
- Hose Clamps
- Gladhands & Accessories
- Air Tanks
- Drain Valves
- Ground Plugs
- Truck Valves
- Selector Valves
- Brass Fittings
- Hose & Tube Chart
- Dash Control Valves
- Air Brake Valves
- Air Accessory Valves
- Air Cylinders
- Switches & Toggles
- Plugs, Sockets & Cables
- RV Plugs & Sockets
- Wire & Cable
- Electrical Harnesses
- Electrical Connectors
- Fuel Caps
- Oil Caps & Dipsticks
- Grease Fittings
- Water Pumps
- Wiper Blades
- Engine Heaters
- Link Cat's Eye®
- Hub Caps, Axilok® & Securex®
- Flitz
- MAXXGreen

## Air Dryer Replacement Cartridges



Sloan No.	Application
401217	WABCO spin-on valve, AD-SP type, Saver 2000
401218	Bendix - AD-4 Air Dryers
401219	Bendix - AD-9 Air Dryers

## Air Brake Diaphragms



Sloan No.	Type	Diameter
461209	9	5"
461212	12	5 1/2"
461216	16	6"
461220	20	6 1/2"
461224	24	7"
461230	30	8"
461236	36	9"

# Air Cylinders

## Tailgate Air Cylinder

Sloan		
No.	Bore	Stroke
400256	2.5"	6"
400258	2.5"	8"
400356	3.5"	6"
400358	3.5"	8"



## Tailgate Kit Manual & Solenoid Operated

Sloan			
No.	Bore	Stroke	Description
402256	2.5"	6"	Manually Operated
403256	2.5"	6"	Solenoid Operated
403258	2.5"	8"	Solenoid Operated
403358	3.5"	8"	Solenoid Operated



## 5th Wheel Cylinder

Sloan		
No.	Bore	Stroke
401267	2-3/4"	6-3/4"



## Forged Yoke Kit

- Includes yoke, pin & cotter pin

Sloan Chamber		
No.	Type	Description
401242	20, 24, 30	5/8" thread clevis assembly, 1/2" pin
401243	9, 12, 16	1/2" thread clevis assembly, 1/2" pin



Tramec
Rubber Hose Assemblies
Coiled Air Assemblies
3-in-1 & 4-in-1 Wraps
Bulk Hose
Air Compressor Discharge Hose Assemblies
Quick Fix™
Air Hose Accessories
Hose Clamps
Gladhands & Accessories
Air Tanks
Drain Valves
Ground Plugs
Truck Valves
Selector Valves
Brass Fittings
Hose & Tube Chart
Dash Control Valves
Air Brake Valves
Air Accessory Valves
<b>Air Cylinders</b>
Switches & Toggles
Plugs, Sockets & Cables
RV Plugs & Sockets
Wire & Cable
Electrical Harnesses
Electrical Connectors
Fuel Caps
Oil Caps & Dipsticks
Grease Fittings
Water Pumps
Wiper Blades
Engine Heaters
Link Cat's Eye®
Hub Caps, Axilok® & Securex®
Flitz
MAXXGreen

## Heavy Duty 4 Way, 3 Position Air Valve

This 3 position detented spool allows for adjusting linkage without shutting off air pressure. Center position blocks air at valve while opening both cylinder ports to atmosphere.



Sloan	
No.	Description
401261	5/8" dia. mounting hole required

## 4 Way, 2 Position Air Valve

- 1/2" dia. mounting hole required



Sloan	
No.	Description
401262	For double acting cylinders, includes tailgate faceplate

## 4 Way, 2 Position Solenoid Valve

- 5 ports 1/4" NPT
- Manual operation override button



Sloan	
No.	Description
401263	With 2 foot 12 volt lead and (2) 1/4" breathers

\*See pages 258 and 259 for installation diagrams\*

## Exhaust Mufflers

Sloan	
No.	Description
401747	1/8" Exhaust Muffler
401748	1/4" Exhaust Muffler
401749	3/8" Exhaust Muffler



# Switches & Toggles

## Low Pressure Switch

- 12 or 24 Volt
- 1/8" NPT
- Circuit normally open at 0 pressure



Sloan	
No.	Description
401238	Actuates at 55 psi
401239	Actuates at 66 psi

## Service Circuit Stoplight Switch

- 12 or 24 Volt
- 1/4" NPT
- Actuates at 3-5 psi



Sloan	
No.	Description
401240	Circuit normally opens at 0 pressure

## Trailer Emergency Stoplight Switch

- 12 or 24 Volt
- 1/8" NPT
- Single pole - double throw
- Actuates at 55 psi



Sloan	
No.	Description
401241	Circuit normally one open and one closed

## LP-3 Low Pressure Indicator

- Normally closed - 0 psi
- Opens at 60 psi

Sloan	
No.	Description
401214	1/4" Single Terminal
401215	1/4" Double Terminal



- Tramec
- Rubber Hose Assemblies
- Coiled Air Assemblies
- 3-in-1 & 4-in-1 Wraps
- Bulk Hose
- Air Compressor Discharge Hose Assemblies
- Quick Fix™
- Air Hose Accessories
- Hose Clamps
- Gladhands & Accessories
- Air Tanks
- Drain Valves
- Ground Plugs
- Truck Valves
- Selector Valves
- Brass Fittings
- Hose & Tube Chart
- Dash Control Valves
- Air Brake Valves
- Air Accessory Valves
- Air Cylinders
- Switches & Toggles
- Plugs, Sockets & Cables
- RV Plugs & Sockets
- Wire & Cable
- Electrical Harnesses
- Electrical Connectors
- Fuel Caps
- Oil Caps & Dipsticks
- Grease Fittings
- Water Pumps
- Wiper Blades
- Engine Heaters
- Link Cat's Eye®
- Hub Caps, Axilok® & Securex®
- Flitz
- MAXXGreen

## SL-4 Stop Light Switch

Sloan No.	Normally Open	Closes	P.T. Supply
401230	0 psi	5 psi	1/4"



## On - Off - On

Sloan No.	Volt	Amp	Terminals & Type
422643	12	50	3 Screw



## On - On

- 1.5" Handle

Sloan No.	Volt	Amp	Terminals & Type
422645	12	50	3 Screw
422646	12	50	Quick Connect



## On - Off - Momentary On

Sloan No.	Volt	Amp	Terminals & Type
422647	12	25LL/35IL	Quick Connect



## Push - Pull

Sloan No.	Volt	Amp	Terminals & Type
422651	6-28	75	2 Screw



# Switches & Toggles

**Precision Ball:  
Screw Terminal**



422685

**Neutral/Back Up Switch**



422686

**Buzzer - Low Air**



422687

**Dimmer Switch**



422690

## Starter Solenoids



421140  
12 VOLT CONTINUOUS DUTY  
SPST  
NO/OFF/ON  
INSULATED  
AMPS:  
85



422688  
12 VOLT INTERMITTENT DUTY  
NO/OFF/ON  
SPST  
INSULATED  
AMPS:  
85

- Tramec
- Rubber Hose Assemblies
- Coiled Air Assemblies
- 3-in-1 & 4-in-1 Wraps
- Bulk Hose
- Air Compressor Discharge Hose Assemblies
- Quick Fix™
- Air Hose Accessories
- Hose Clamps
- Gladhands & Accessories
- Air Tanks
- Drain Valves
- Ground Plugs
- Truck Valves
- Selector Valves
- Brass Fittings
- Hose & Tube Chart
- Dash Control Valves
- Air Brake Valves
- Air Accessory Valves
- Air Cylinders
- Switches & Toggles**
- Plugs, Sockets & Cables
- RV Plugs & Sockets
- Wire & Cable
- Electrical Harnesses
- Electrical Connectors
- Fuel Caps
- Oil Caps & Dipsticks
- Grease Fittings
- Water Pumps
- Wiper Blades
- Engine Heaters
- Link Cat's Eye®
- Hub Caps, Axilok® & Securex®
- Flitz
- MAXXGreen



## Ignition Switches



422648  
ACC., OFF,  
IGN. &  
ACC., IGN.  
Start



422661  
ACC., OFF,  
IGN. & ACC.,  
IGN. Start



422662  
ACC., OFF,  
IGN. &  
ACC., IGN.  
Start



422663  
REPLACES  
IHC  
167603R91  
&  
344688C91



422649  
ON/OFF

## Toggle Switches



422664  
ON/OFF  
DPST  
4 SCREWS  
25 AMPS  
12 VOLTS



422665  
ON/ON  
DPDT  
6 SCREWS  
25 AMPS  
12 VOLT

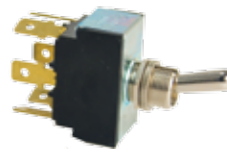

422666  
ON/ON  
DPDT  
6 BLADES  
25 AMPS  
12 VOLT



422667  
ON/OFF/ON  
DPDT  
6 SCREWS  
35 Inductive  
25 Lampload

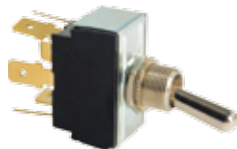

422668  
ON/OFF/ON  
DPDT  
6 BLADES  
25 AMPS  
12 VOLT



422669  
MOM ON/OFF/  
MOM ON  
DPDT  
6 SCREWS  
25 AMPS  
12 VOLTS



422671  
MOM ON/OFF/  
MOM ON  
DPDT  
6 BLADES  
25 AMPS  
12 VOLTS



422672  
ON/OFF  
SPST  
S BLADES  
50 AMPS

# Switches & Toggles

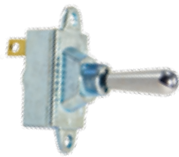

422642  
ON/OFF  
SPST  
S SCREWS  
50 AMPS  
12 Volts



422673  
ON/OFF  
SPST  
2 BLADES  
50 AMPS  
12 Volts



422674  
MOM ON/OFF/  
MOM ON  
SPDT  
3 SCREWS  
50 AMPS  
12 Volts



422675  
ON/OFF  
SPST  
2 SCREWS  
25 AMPS  
12 Volts



422676  
ON/OFF  
SPST  
2 BLADES  
25 AMPS  
12 Volts



422677  
ON/ON  
SPDT  
3 SCREWS  
25 AMPS  
12 Volts



422679  
ON/OFF/ON  
SPDT  
3 SCREWS  
25 AMPS  
12 Volts



422680  
ON/OFF/ON  
SPDT  
3 BLADES  
25 AMPS  
12 VOLTS

## Momentary Push Switches



422681  
  
60 AMPS  
12 Volts



422682  
  
AMPS:  
60



422684  
  
15 AMPS  
12 Volts

## Axle Switches



422652  
LIMIT SWITCH  
2-SPEED  
HI/LOW AXLE



422653  
EATON 2-SPEED  
HI/LO AXLE

- Tramec
- Rubber Hose Assemblies
- Coiled Air Assemblies
- 3-in-1 & 4-in-1 Wraps
- Bulk Hose
- Air Compressor Discharge Hose Assemblies
- Quick Fix™
- Air Hose Accessories
- Hose Clamps
- Gladhands & Accessories
- Air Tanks
- Drain Valves
- Ground Plugs
- Truck Valves
- Selector Valves
- Brass Fittings
- Hose & Tube Chart
- Dash Control Valves
- Air Brake Valves
- Air Accessory Valves
- Air Cylinders
- Switches & Toggles
- Plugs, Sockets & Cables
- RV Plugs & Sockets
- Wire & Cable
- Electrical Harnesses
- Electrical Connectors
- Fuel Caps
- Oil Caps & Dipsticks
- Grease Fittings
- Water Pumps
- Wiper Blades
- Engine Heaters
- Link Cat's Eye®
- Hub Caps, Axilok® & Securex®
- Flitz
- MAXXGreen

## Push/Pull Switches

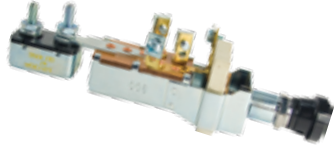

422692  
OFF/ON/ON

AMPS:  
20



422693  
OFF/ON/ON

W/FUSE  
AMPS:  
15



422694  
OFF/ON/ON

AMPS:  
15



422695  
OFF/ON

AMPS:  
15

## Master Disconnect Switches



422696  
OFF/ON  
SPST  
AMPS:  
180



422697  
OFF/ON  
DPST  
AMPS:  
180



422698  
FACE PLATE

# Switches & Toggles

## Circuit Breaker-Push Button



422699  
AMPS:  
150



422700  
AMPS:  
100



422701  
AMPS:  
120



422702  
AMPS:  
60



422703  
AMPS:  
80

## Push/Momentary Switches



422711  
NORMALLY ON  
DPST  
4 SCREWS



422712  
ON/MOM OFF/ON  
TWO CIRCUIT  
4 SCREWS



422713  
ON/MOM OFF/MOM ON  
FOUR CIRCUIT  
6 SCREWS



422714  
NORMALLY ON  
DPST  
BLADE TERMINALS



422705  
AIR PRESSURE  
SWITCH  
CONTACT OPEN AT  
RISING PRESSURE



422707  
OIL PRESSURE /  
ELECTRIC CHOKE  
SWITCH  
NORMALLY OFF  
INSULATED  
SPST  
ON AT 2-6 PSI



422709  
STOP LAMP SWITCH  
NORMALLY OFF  
SPST  
OPERATES 60-120PSI  
CONTACT CLOSED AT  
RISING PRESSURE



422710  
STOP LAMP SWITCH  
NORMALLY OFF  
SPST  
OPERATES 60-120 PSI  
CONTACT CLOSED AT  
RISING PRESSURE

- Tramec
- Rubber Hose Assemblies
- Coiled Air Assemblies
- 3-in-1 & 4-in-1 Wraps
- Bulk Hose
- Air Compressor Discharge Hose Assemblies
- Quick Fix™
- Air Hose Accessories
- Hose Clamps
- Gladhands & Accessories
- Air Tanks
- Drain Valves
- Ground Plugs
- Truck Valves
- Selector Valves
- Brass Fittings
- Hose & Tube Chart
- Dash Control Valves
- Air Brake Valves
- Air Accessory Valves
- Air Cylinders
- Switches & Toggles
- Plugs, Sockets & Cables
- RV Plugs & Sockets
- Wire & Cable
- Electrical Harnesses
- Electrical Connectors
- Fuel Caps
- Oil Caps & Dipsticks
- Grease Fittings
- Water Pumps
- Wiper Blades
- Engine Heaters
- Link Cat's Eye®
- Hub Caps, Axilok® & Securex®
- Flitz
- MAXXGreen

## 7-Way Sockets

- Brass contact pin screws - will not cut copper wires.
- Built-in receptacle "ledge" - for plug/cable support - relieves strain on contact pins and plug bushings - also reduces chance of flickering - no lights - from plug drop-out on trailers.
- Splash-proof lid design - overlap design prevents water spray - no need for gaskets.
- Indexed and lock pin with "floating" design for easy plug engagement prevents contact pin bending.
- Partitioned insert design reduces chances of wire shorts.
- Each terminal clearly marked to insure correct circuit wiring.
- Heavy duty insert anchor screws.

## Zinc Die-Cast and Nylon



Sloan No.	Description
421015	Split pin, side entry terminal
421119	Solid pin, rear entry terminal
421121	Solid pin, rear bullet entry terminal
421124	Solid pin, side entry terminal
421149	Solid pin, side entry terminal, nylon
421150	Split pin, side entry terminal, nylon

## 7-Way Nylon ISO Socket



Sloan No.	Description
421163	ISO with ring termination

## 6-Way Sockets



421123

Sloan No.	Description
421123	Exposed terminals
421136	Concealed terminals

## 4-Way Sockets



Sloan No.	Description
421176	Split pin, rear entry

# Plugs, Sockets & Cables

## Single & Double Pole Sockets



Sloan No.	Description
421126	Single Pole
421171	Double Pole

## 7-Way Socket - Large Flange Zinc Die-Cast



\*Adapter plate available for conversion to a regular 7-way socket mount, P/N 421285.

Sloan No.	Circuit Breaker	Pin Type	Description
421019	20 Amp.	split pin	Socket Only
421021	30 Amp.	split pin	Socket Only
421053	none	split pin	with small nose box
421120	20 Amp.	split pin	with nylon nose box
421168	15 Amp.	split pin	Socket Only
421272	none	none	Nose Box & Seals Only
421283	15 Amp.	split pin	with nylon nose box
421284	30 Amp.	split pin	with nylon nose box
421286	none	split pin	Socket only
421287	none	none	Aluminum nose box only
431745	Nose box back gasket		
431746	Nose box front gasket		
431747	Nose box grommet seal		

## Circuit Breakers

- 12 volt
- Complies with SAE J533



Sloan No.	Description	Mounting Type
421141	15 Amp. with metal base.	Bracket
421142	20 Amp. with metal base.	Bracket
421143	30 Amp. with metal base.	Bracket
421144	40 Amp. with metal base.	Bracket
422655	15 Amp. with metal base	Snap-in
422656	20 Amp. with metal base	Snap-in
422657	30 Amp. with metal base	Snap-in
422658	40 Amp. with metal base	Snap-in

## 7-Way Socket Accessories



Sloan No.	Description
421749	Rubber boot keeps sockets clean and dry
421152	Split pin socket interior for 421125
421153	Solid pin socket interior for 421124 and 421149

- Tramec
- Rubber Hose Assemblies
- Coiled Air Assemblies
- 3-in-1 & 4-in-1 Wraps
- Bulk Hose
- Air Compressor Discharge Hose Assemblies
- Quick Fix™
- Air Hose Accessories
- Hose Clamps
- Gladhands & Accessories
- Air Tanks
- Drain Valves
- Ground Plugs
- Truck Valves
- Selector Valves
- Brass Fittings
- Hose & Tube Chart
- Dash Control Valves
- Air Brake Valves
- Air Accessory Valves
- Air Cylinders
- Switches & Toggles
- Plugs, Sockets & Cables
- RV Plugs & Sockets
- Wire & Cable
- Electrical Harnesses
- Electrical Connectors
- Fuel Caps
- Oil Caps & Dipsticks
- Grease Fittings
- Water Pumps
- Wiper Blades
- Engine Heaters
- Link Cat's Eye®
- Hub Caps, Axilok® & Securex®
- Flitz
- MAXXGreen

## Standard 7-Way Plug

- Meets SAE J560.
- Center clamp for "Bear-Bite" cable grips to prevent cable pull-out. Provides for easy deliberate plug push-in and pull-out.
- Fully interchangeable with SAE Compliant, 7-way connectors.
- Heavy duty brass insert wire retainer screws.

## Zinc Die Cast

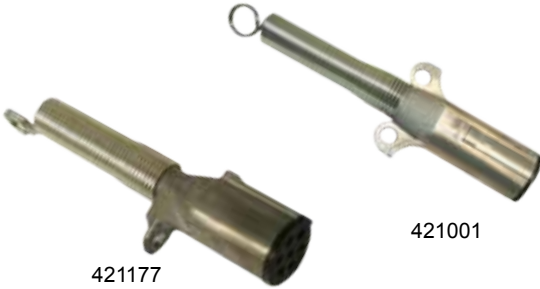

Sloan No.	Description
421000	Plug assembly without spring
421001	Plug assembly with spring
421177	Plug assembly with spring (single grip)

## Glass Filled Nylon



Sloan No.	Description
421147	Plug assembly with spring
421148	Plug assembly without spring

## 7-Way Plug ISO Zinc Die Cast



Sloan No.	Description
421162	ISO plug assembly with spring

## 7-Way Plug & Socket Cleaner

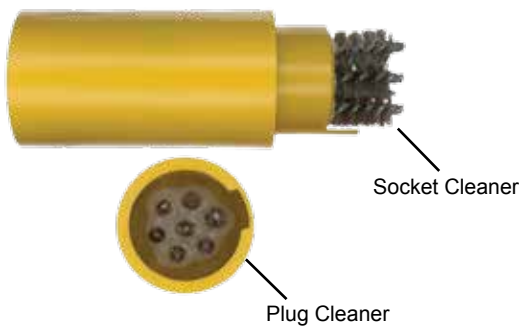

Sloan No.	Description
422317	Plug & Socket Cleaner

# Plugs, Sockets & Cables

## 6-Way Plug

- Brass terminal pins for best conductivity.
- Accepts up to #12 gauge wires.
- Finger grips for positive pull.



Sloan No.	Description
421122	Plug assembly with spring
421135	Plug assembly without spring

## 4-Way Plugs



Sloan No.	Description
421174	Plug assembly without spring
421175	Plug assembly with spring

## Single & Double Pole Plugs



Sloan No.	Description
421127	Single pole plug assembly with spring
421170	Double pole plug assembly with spring

## 7-Way Replacement Parts



Sloan No.	Description
421151	Plug interior for 421147 and 421148. With mounting screw.

## Spring Guard



Sloan No.	Description
421237	7-way spring guard

<b>Tramec</b>
<b>Rubber Hose Assemblies</b>
<b>Coiled Air Assemblies</b>
<b>3-in-1 &amp; 4-in-1 Wraps</b>
<b>Bulk Hose</b>
<b>Air Compressor Discharge Hose Assemblies</b>
<b>Quick Fix™</b>
<b>Air Hose Accessories</b>
<b>Hose Clamps</b>
<b>Gladhands &amp; Accessories</b>
<b>Air Tanks</b>
<b>Drain Valves</b>
<b>Ground Plugs</b>
<b>Truck Valves</b>
<b>Selector Valves</b>
<b>Brass Fittings</b>
<b>Hose &amp; Tube Chart</b>
<b>Dash Control Valves</b>
<b>Air Brake Valves</b>
<b>Air Accessory Valves</b>
<b>Air Cylinders</b>
<b>Switches &amp; Toggles</b>
<b>Plugs, Sockets &amp; Cables</b>
<b>RV Plugs &amp; Sockets</b>
<b>Wire &amp; Cable</b>
<b>Electrical Harnesses</b>
<b>Electrical Connectors</b>
<b>Fuel Caps</b>
<b>Oil Caps &amp; Dipsticks</b>
<b>Grease Fittings</b>
<b>Water Pumps</b>
<b>Wiper Blades</b>
<b>Engine Heaters</b>
<b>Link Cat's Eye®</b>
<b>Hub Caps, Axilok® &amp; Securex®</b>
<b>Flitz</b>
<b>MAXXGreen</b>



## Junction Box

- Constructed of high-impact plastic for added durability and long-lasting life.
- With circuit breaker bracket.
- 4 collar positions

Sloan No.	Description	Figure
421128	With 7 post wire connections and fastener hardware	A
421246	With 7 post wire connections and fastener hardware	B
422327	6-Port Junction Box, Circuit breakers, insert and bracket	C
422328	6-Port Junction Box, 10-stud	D
422329	Sealed Multi-Port Junction Box, 20-stud assembly	E
422634	With 7 post wire connections and fastener hardware	F
422635	With circuit breaker bracket, circuit breakers not included	G

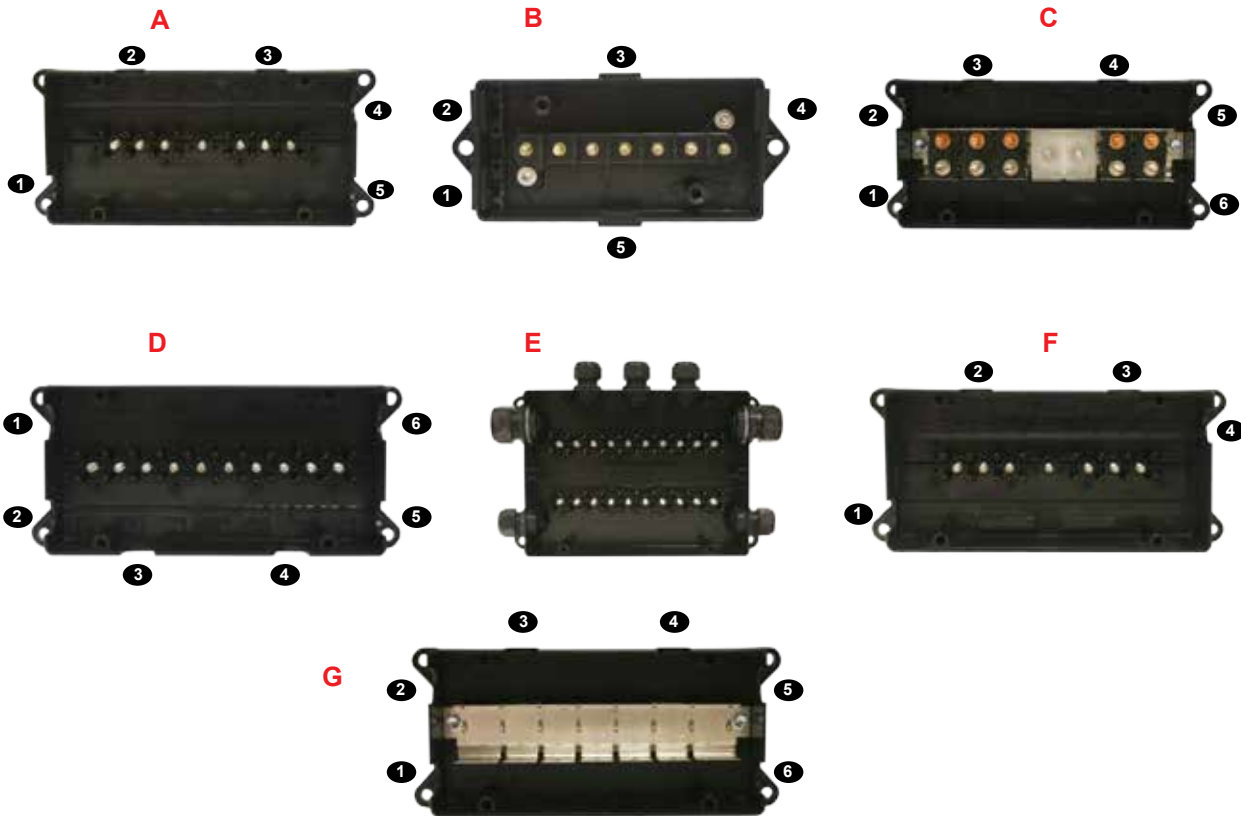

## 7-Way Circuit Inspector



Sloan No.	Description
421758	Instantly finds and repairs short or faulty circuits in the shop or on the road. Comes with protective nylon case.

# Plugs, Sockets & Cables



## Coiled and Straight Cable with 7-Way Plug

- Large connector finger grips for easy disconnection.
- Connector pins are double crimped for maximum durability.
- Plugs meet SAE J560.

Heavy duty SAE J2394 construction designed for use on ABS systems where either the #4 red stop lamp circuit or #7 blue circuit are used. Recommended for all ABS applications.

### ElectraPlus 7-Way Coiled Cable w/ Metal Plugs ABS - Green Jacket

Sloan No.	Working Length	Description
421129	12'	(2) 12" leads, (2) metal plugs
421130	15'	(2) 12" leads, (2) metal plugs
421155	15'	(1) 12" lead, (1) 40" lead, (2) metal plugs
421204	20'	(2) 12" leads, (2) metal plugs
421205	15'	(1) 12" lead, (1) 72" lead, (2) metal plugs
421206	20'	(1) 12" lead, (1) 72" lead, (2) metal plugs
421207	20'	(1) 12" lead, (1) 40" lead, (2) metal plugs
421208	12'	(2) 12" leads, (1) metal plug
421209	15'	(2) 12" leads, (1) metal plug
421210	15'	(1) 72" lead, (1) 12" lead with metal plug



Coiled With Metal Plugs



Coiled With Plastic Plugs

### ElectraPlus 7-Way Coiled Cable w/ Plastic Plugs ABS - Green Jacket

Sloan No.	Working Length	Description
421156	12'	(2) 12" leads, (2) plastic plugs
421157	15'	(2) 12" leads, (2) plastic plugs
421203	15'	(1) 48" lead, (1) 12" lead, (2) plastic plugs



Straight With Metal Plugs

### ElectraPlus 7-Way Straight Cable w/ Metal Plugs ABS - Green Jacket

Sloan No.	Working Length	Description
421166	12'	Straight, metal plugs
421167	15'	Straight, metal plugs
421199	10'	Straight, metal plugs
421247	20'	Straight, metal plugs

### ElectraPlus 7-Way Straight Cable w/ Plastic Plugs ABS - Green Jacket

Sloan No.	Working Length	Description
421200	15'	Straight, plastic plugs
421201	10'	Straight, plastic plugs
421202	12'	Straight, plastic plugs

#### CIRCUIT IDENTIFICATION

Pin No.	ATS Color Code	Circuit
1	White	Ground return.
2	Black	Clearance, side marker, and ident. lamps.
3	Yellow	Left turn signal & hazard signal.
4	Red	Stop lamp & anti-lock devices.
5	Green	Right turn signal & hazard signal.
6	Brown	Tail and license plate lamps.
7	Blue	Auxiliary circuit/ABS power.

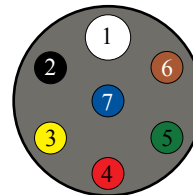

- 1 - WHITE 8 GA.
- 2 - BLACK 12 GA.
- 3 - YELLOW 12 GA.
- 4 - RED 10 GA.
- 5 - GREEN 12 GA.
- 6 - BROWN 12 GA.
- 7 - BLUE (ABS power) 10 GA.

- Tramec
- Rubber Hose Assemblies
- Coiled Air Assemblies
- 3-in-1 & 4-in-1 Wraps
- Bulk Hose
- Air Compressor Discharge Hose Assemblies
- Quick Fix™
- Air Hose Accessories
- Hose Clamps
- Gladhands & Accessories
- Air Tanks
- Drain Valves
- Ground Plugs
- Truck Valves
- Selector Valves
- Brass Fittings
- Hose & Tube Chart
- Dash Control Valves
- Air Brake Valves
- Air Accessory Valves
- Air Cylinders
- Switches & Toggles
- Plugs, Sockets & Cables
- RV Plugs & Sockets
- Wire & Cable
- Electrical Harnesses
- Electrical Connectors
- Fuel Caps
- Oil Caps & Dipsticks
- Grease Fittings
- Water Pumps
- Wiper Blades
- Engine Heaters
- Link Cat's Eye®
- Hub Caps, Axilok® & Securex®
- Flitz
- MAXXGreen

## 7-Way Coiled Cable w/Plugs ISO - Yellow Jacket

For Trailer System Monitoring,  
Reefer And Cargo Information.

Sloan No.	Working Length	Description
421159	12'	(2) 12" leads, (2) metal plugs
421160	15'	(2) 12" leads, (2) metal plugs
421214	15'	(1) 72" lead, (1) 12" lead, (2) metal plugs
421215	15'	(1) 48" lead, (1) 12" lead, (2) metal plugs
421216	12'	(2) 12" leads, (1) metal plug
421217	15'	(1) 72" lead, (1) 12" lead with metal plug
421218	15'	(2) 12" lead, (1) metal plug

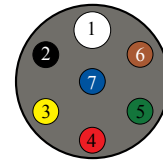

## 7-Way Straight Cable w/Plugs ISO - Yellow Jacket

Sloan No.	Working Length	Description
421178	12'	Straight
421179	15'	Straight
421213	10'	Straight, metal plugs

- 1 - WHITE 8 GA.
- 2 - BLACK 12 GA.
- 3 - YELLOW 12 GA.
- 4 - RED 10 GA.
- 5 - GREEN 12 GA.
- 6 - BROWN 12 GA.
- 7 - BLUE (ABS power) 10 GA.

## PowerPlus 7-Way Coiled Cable w/Plugs, Black Jacket

Sloan No.	Working Length	Description
421007	12'	(2) 12" leads, metal plugs
421115	15'	(2) 12" leads, metal plugs
421185	15'	(1) 40" lead, metal plugs
421229	20'	(2) 12" leads, metal plugs
421230	15'	(1) 12" lead, (1) 72" lead, 1 plug
421231	15'	(1) 72" lead, metal plugs
421232	10'	(2) 12" leads, metal plugs
421233	12'	(2) 12" leads, (1) metal plug
421234	15'	(2) 12" leads, (1) metal plug
421235	20'	(1) 12" lead, (1) 72" lead

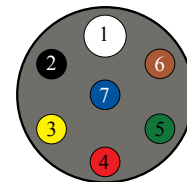

## PowerPlus 7-Way Straight Cable w/Plugs, Black Jacket

Sloan No.	Working Length	Description
421225	8'	Straight cable, metal plugs
421226	10'	Straight cable, metal plugs
421227	12'	Straight cable, metal plugs
421228	15'	Straight cable, metal plugs

- 1 - WHITE 10 GA.
- 2 - BLACK 12 GA.
- 3 - YELLOW 12 GA.
- 4 - RED 12 GA.
- 5 - GREEN 12 GA.
- 6 - BROWN 12 GA.
- 7 - BLUE 12 GA.

# Plugs, Sockets & Cables

## Economy 7-Way Coiled Cable w/Plugs, Black Jacket

Sloan No.	Working Length	Description
421010	12'	(2) 12" leads, (2) metal plugs
421113	15'	(2) 12" leads, (2) metal plugs
421180	15'	(1) 12" lead, (1) 48" lead, (2) metal plugs

Where 14 Gauge Is Considered Adequate. Durable And Economical.

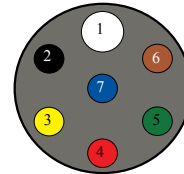

- 1 - WHITE 12 GA.
- 2 - BLACK 14 GA.
- 3 - YELLOW 14 GA.
- 4 - RED 14 GA.
- 5 - GREEN 14 GA.
- 6 - BROWN 14 GA.
- 7 - BLUE 14 GA.

## Economy 7-Way Straight Cable w/Plugs, Black Jacket

Sloan No.	Working Length	Description
421164	12'	Straight
421165	15'	Straight

## Single and Double Pole Coiled Cable with Plugs

- 4 gauge fine strand copper wire.
- Flexible to temperatures to -85°F (-65°C)
- Jacket is resistant to gasoline, diesel fuel and commonly used chemicals.
- Maximum current carrying capacity 200 amps for 12 volt intermittent liftgate use.

Sloan No.	Working Length	Description	Usage
421145	12'	(2) 12" leads, (2) single pole plugs w/spring	Lift gate
421146	15'	(2) 12" leads, (2) single pole plugs w/spring	and remote
421172	12'	(2) 12" leads, (2) double pole plugs w/spring	charging
421173	15'	(2) 12" leads, (2) double pole plugs w/spring	applications
421236	15'	(1) 12" lead, (1) 40" lead, (2) Single pole plugs	



## 6-Way Coiled Cable (6-14GA)

Sloan No.	Working Length	Description
421187	15'	(2) 12" leads, (2) metal plugs
421188	10'	(2) 12" leads, (2) metal plugs
421189	10'	(2) 12" leads, (1) metal plug
421190	8'	(2) 12" leads, (1) metal plug
421191	6'	(2) 12" leads, (2) metal plugs
421192	6'	(2) 12" leads, (1) metal plug

## 4-Way Coiled Cable (4-14GA)

Sloan No.	Working Length	Description
421193	15'	(2) 12" leads (2) metal plugs
421194	12'	(2) 12" leads (1) metal plug
421195	10'	(2) 12" leads (2) metal plugs
421196	10'	(2) 12" leads (1) metal plug
421197	8'	(2) 12" leads (1) metal plug
421198	6'	(2) 12" leads (2) metal plugs

## 4 & 6-Way RV Coil

Sloan No.	Working Length	Description
421181	8'	4-Way Coil (4/14) with Plugs
421182	12'	4-Way Coil (4/14) with Plugs
421183	8'	6-Way Coil (6/14) with Plugs
421184	12'	6-Way Coil (6/14) with Plugs



- Tramec
- Rubber Hose Assemblies
- Coiled Air Assemblies
- 3-in-1 & 4-in-1 Wraps
- Bulk Hose
- Air Compressor Discharge Hose Assemblies
- Quick Fix™
- Air Hose Accessories
- Hose Clamps
- Gladhands & Accessories
- Air Tanks
- Drain Valves
- Ground Plugs
- Truck Valves
- Selector Valves
- Brass Fittings
- Hose & Tube Chart
- Dash Control Valves
- Air Brake Valves
- Air Accessory Valves
- Air Cylinders
- Switches & Toggles
- Plugs, Sockets & Cables
- RV Plugs & Sockets
- Wire & Cable
- Electrical Harnesses
- Electrical Connectors
- Fuel Caps
- Oil Caps & Dipsticks
- Grease Fittings
- Water Pumps
- Wiper Blades
- Engine Heaters
- Link Cat's Eye®
- Hub Caps, Axilok® & Securex®
- Flitz
- MAXXGreen

## 7-Way RV Plugs

- Thermoplastic material eliminates rusting, poor appearance and difficulty in plug removal.
- Blade type pin.
- Dual grips for easy plug removal.



Sloan No.	Description
421137	Heavy Duty 7-Way plug for RV (trailer end)

## 7-Way RV Sockets

- Thermoplastic material.
- Blade type pin.



Sloan No.	Description
421138	Heavy Duty 7-Way socket for RV (car end)

## 5-Way Plug Chrome Plated



Sloan No.	Description
421133	Plug assembly without spring

## 4-Way Plug Chrome Plated



Sloan No.	Description
421131	Plug assembly without spring

## Connector Adapter

- Allows one vehicle to tow either campers or boats.
- Connects ground, L.T., R.T., and stop circuits.
- Quick and easy to connect.
- Full length plug shell ensures positive latching.
- Non-corrosive nylon shell and insert.
- Eliminate makeshift jumpers.



Sloan No.	Description
421139	Converts 7-way blade to 4-way molded connector.

## 5-Way Sockets - Chrome Plated



Sloan No.	Description
421134	Split pin, 2 hole mount, chrome plated

## 4-Way Sockets - Chrome Plated



Sloan No.	Description
421132	Split pin, 2 hole mount, chrome plated

\*Note: Not interchangeable with plugs 421174, 421175, and 421176.

<b>Tramec</b>
<b>Rubber Hose Assemblies</b>
<b>Coiled Air Assemblies</b>
<b>3-in-1 &amp; 4-in-1 Wraps</b>
<b>Bulk Hose</b>
<b>Air Compressor Discharge Hose Assemblies</b>
<b>Quick Fix™</b>
<b>Air Hose Accessories</b>
<b>Hose Clamps</b>
<b>Gladhands &amp; Accessories</b>
<b>Air Tanks</b>
<b>Drain Valves</b>
<b>Ground Plugs</b>
<b>Truck Valves</b>
<b>Selector Valves</b>
<b>Brass Fittings</b>
<b>Hose &amp; Tube Chart</b>
<b>Dash Control Valves</b>
<b>Air Brake Valves</b>
<b>Air Accessory Valves</b>
<b>Air Cylinders</b>
<b>Switches &amp; Toggles</b>
<b>Plugs, Sockets &amp; Cables</b>
<b>RV Plugs &amp; Sockets</b>
<b>Wire &amp; Cable</b>
<b>Electrical Harnesses</b>
<b>Electrical Connectors</b>
<b>Fuel Caps</b>
<b>Oil Caps &amp; Dipsticks</b>
<b>Grease Fittings</b>
<b>Water Pumps</b>
<b>Wiper Blades</b>
<b>Engine Heaters</b>
<b>Link Cat's Eye®</b>
<b>Hub Caps, Axilok® &amp; Securex®</b>
<b>Flitz</b>
<b>MAXXGreen</b>

## Battery Cable

- Constructed with soft annealed, flexible stranded copper.
- Insulated with high quality thermoplastic.
- Meets SAE J1127 type SGT.

Part Number	AWG Size	Stranding	Nom. O.D. (Inches)	Jacket Color	Length
422241	6	49	.308	red	25'
422242	6	49	.308	red	100'
422243	6	49	.308	black	25'
422244	6	49	.308	black	100'
422245	4	133	.350	red	25'
422246	4	133	.350	red	100'
422247	4	133	.350	black	25'
422248	4	133	.350	black	100'
422249	2	133	.455	red	25'
422250	2	133	.455	red	100'
422251	2	133	.455	black	25'
422252	2	133	.455	black	100'
422253	1	133	.490	red	25'
422254	1	133	.490	red	100'
422255	1	133	.490	black	25'
422256	1	133	.490	black	100'
422257	1/0	133	.535	red	25'
422258	1/0	133	.535	red	100'
422259	1/0	133	.535	black	25'
422260	1/0	133	.535	black	100'
422261	2/0	133	.585	red	25'
422262	2/0	133	.585	red	100'
422263	2/0	133	.585	red	250'
422264	2/0	133	.585	black	25'
422265	2/0	133	.585	black	100'
422266	2/0	133	.585	black	250'
422267	3/0	259	.675	black	25'
422268	3/0	259	.675	black	100'
422269	4/0	259	.740	black	25'
422270	4/0	259	.740	black	100'

Electrical Products



## Charging Cable



Part Number	Length	Cond. Gauge	Color	O.D.
422503	100'	2 / 4 Ga.	Blue	.035

# Wire & Cable



## Primary Type GPT Hook-up Wire

- GPT-type primary wire is the most widely used general purpose wire used by O.E.M.'s and re-wiring accessory installers.
- Constructed with soft annealed, flexible stranded copper.
- Insulated with high quality PVC thermoplastic.
- Meets SAE J1128 Type GPT.

Part Number	AWG Size	Stranding	Nom. O.D. (Inches)	Color	Length
422273	18	16	.095	black	100'
422274	18	16	.095	blue	100'
422275	18	16	.095	brown	100'
422276	18	16	.095	green	100'
422277	18	16	.095	red	100'
422278	18	16	.095	white	100'
422279	18	16	.095	yellow	100'
422280	16	19	.106	black	100'
422280-1000	16	19	.106	black	1000'
422281	16	19	.106	blue	100'
422281-1000	16	19	.106	blue	1000'
422282	16	19	.106	brown	100'
422282-1000	16	19	.106	brown	1000'
422283	16	19	.106	green	100'
422283-1000	16	19	.106	green	1000'
422284	16	19	.106	red	100'
422284-1000	16	19	.106	red	1000'
422285	16	19	.106	white	100'
422285-1000	16	19	.106	white	1000'
422286	16	19	.106	yellow	100'
422286-1000	16	19	.106	yellow	1000'
422287	14	19	.118	black	100'
422287-1000	14	19	.118	black	1000'
422288	14	19	.118	blue	100'
422288-1000	14	19	.118	blue	1000'
422289	14	19	.118	brown	100'
422289-1000	14	19	.118	brown	1000'
422290	14	19	.118	green	100'
422290-1000	14	19	.118	green	1000'
422291	14	19	.118	red	100'
422291-1000	14	19	.118	red	1000'
422292	14	19	.118	white	100'
422292-1000	14	19	.118	white	1000'
422293	14	19	.118	yellow	100'
422293-1000	14	19	.118	yellow	1000'
422294	12	19	.143	black	100'
422294-1000	12	19	.143	black	1000'
422295	12	19	.143	blue	100'
422295-1000	12	19	.143	blue	1000'



- Tramec**
- Rubber Hose Assemblies**
- Coiled Air Assemblies**
- 3-in-1 & 4-in-1 Wraps**
- Bulk Hose**
- Air Compressor Discharge Hose Assemblies**
- Quick Fix™**
- Air Hose Accessories**
- Hose Clamps**
- Gladhands & Accessories**
- Air Tanks**
- Drain Valves**
- Ground Plugs**
- Truck Valves**
- Selector Valves**
- Brass Fittings**
- Hose & Tube Chart**
- Dash Control Valves**
- Air Brake Valves**
- Air Accessory Valves**
- Air Cylinders**
- Switches & Toggles**
- Plugs, Sockets & Cables**
- RV Plugs & Sockets**
- Wire & Cable**
- Electrical Harnesses**
- Electrical Connectors**
- Fuel Caps**
- Oil Caps & Dipsticks**
- Grease Fittings**
- Water Pumps**
- Wiper Blades**
- Engine Heaters**
- Link Cat's Eye®**
- Hub Caps, Axilok® & Securex®**
- Flitz**
- MAXXGreen**



## Primary Type GPT Hook-up Wire Cont.



Sloan No.	AWG Size	Stranding	Nom. O.D. (Inches)	Color	Length
422296	12	19	.143	brown	100'
422296-1000	12	19	.143	brown	1000'
422297	12	19	.143	green	100'
422297-1000	12	19	.143	green	1000'
422298	12	19	.143	red	100'
422298-1000	12	19	.143	red	1000'
422299	12	19	.143	white	100'
422299-1000	12	19	.143	white	1000'
422300	12	19	.143	yellow	100'
422300-1000	12	19	.143	yellow	1000'
422301	10	19	.174	black	100'
422302	10	19	.174	blue	100'
422303	10	19	.174	brown	100'
422304	10	19	.174	green	100'
422305	10	19	.174	red	100'
422306	10	19	.174	white	100'
422307	10	19	.174	yellow	100'
422308	8	37	.205	black	100'
422309	8	37	.205	red	100'
422492	8	37	.205	blue	100'
422493	8	37	.205	white	100'

## Welding Cable



Sloan No.	Length	Gauge	Color	O.D.
422499	25'	1/0	Black	.580
422500	25'	2/0	Black	.615
422501	25'	4	Black	.380

## Extension Cable



Sloan No.	Length	Gauge	Colors	Cond. O.D.
422502	250'	3 / 16 Ga.	Black White Green	.325

# Wire & Cable



## Trailer Cable - Black Jacket

- Jacket is temperature rated at -70°F to +185°F.
- Resistant to gasoline, water solvents, abrasion, cutting, ozone, and sunlight.
- Exceeds SAE standards.

Sloan No.	AWG Size	No. of Conductors	Stranding	O.D.	Colors							Length
					BK	BL	BN	GN	R	W	Y	
422215	14	4	41	.440	---	---	BN	GN	---	W	Y	50'
422216	14	4	41	.440	---	---	BN	GN	---	W	Y	100'
422217	14	4	41	.440	---	---	BN	GN	---	W	Y	250'
422218	14	4	41	.440	---	---	BN	GN	---	W	Y	500'
422219	14	4	41	.440	---	---	BN	GN	---	W	Y	1000'
422220	14	6	41	.525	BK	BL	BN	---	R	W	Y	50'
422221	14	6	41	.525	BK	BL	BN	---	R	W	Y	100'
422222	14	6	41	.525	BK	BL	BN	---	R	W	Y	250'
422223	14	6	41	.525	BK	BL	BN	---	R	W	Y	500'
422224	14	6	41	.525	BK	BL	BN	---	R	W	Y	1000'
422471	14	7	41	.600	BK	BL	BN	GN	R	W	Y	100'
422225	6@14	6	41	.525	BK	BL	BN	GN	R	---	Y	---
	1@12	1	65	.525	---	---	---	---	---	W	---	50'
422226	6@14	6	41	.525	BK	BL	BN	GN	R	---	Y	---
	1@12	1	65	.525	---	---	---	---	---	W	---	100'
422227	6@14	6	41	.525	BK	BL	BN	GN	R	---	Y	---
	1@12	1	65	.525	---	---	---	---	---	W	---	250'
422228	6@14	6	41	.525	BK	BL	BN	GN	R	---	Y	---
	1@12	1	65	.525	---	---	---	---	---	W	---	500'
422229	6@14	6	41	.525	BK	BL	BN	GN	R	---	Y	---
	1@12	1	65	.525	---	---	---	---	---	W	---	1000'
422230	6@12	6	65	.610	BK	BL	BN	GN	R	---	Y	---
	1@10	1	104	.610	---	---	---	---	---	W	---	50'
422231	6@12	6	65	.610	BK	BL	BN	GN	R	---	Y	---
	1@10	1	104	.610	---	---	---	---	---	W	---	100'
422232	6@12	6	65	.610	BK	BL	BN	GN	R	---	Y	---
	1@10	1	104	.610	---	---	---	---	---	W	---	250'
422233	6@12	6	65	.610	BK	BL	BN	GN	R	---	Y	---
	1@10	1	104	.610	---	---	---	---	---	W	---	500'
422234	6@12	6	65	.610	BK	BL	BN	GN	R	---	Y	---
	1@10	1	104	.610	---	---	---	---	---	W	---	1000'
422477	2@14	2	---	---	BK	---	---	---	---	W	---	250'
422479	3@14	3	---	---	BK	---	---	---	R	W	---	100'
422481	7@14	7	---	---	BK	BL	BN	GN	R	W	Y	50'
422482	7@14	7	---	---	BK	BL	BN	GN	R	W	Y	250'
422483	7@14	7	---	---	BK	BL	BN	GN	R	W	Y	500'
422484	7@14	7	---	---	BK	BL	BN	GN	R	W	Y	1000'



- Tramec**
- Rubber Hose Assemblies**
- Coiled Air Assemblies**
- 3-in-1 & 4-in-1 Wraps**
- Bulk Hose**
- Air Compressor Discharge Hose Assemblies**
- Quick Fix™**
- Air Hose Accessories**
- Hose Clamps**
- Gladhands & Accessories**
- Air Tanks**
- Drain Valves**
- Ground Plugs**
- Truck Valves**
- Selector Valves**
- Brass Fittings**
- Hose & Tube Chart**
- Dash Control Valves**
- Air Brake Valves**
- Air Accessory Valves**
- Air Cylinders**
- Switches & Toggles**
- Plugs, Sockets & Cables**
- RV Plugs & Sockets**
- Wire & Cable**
- Electrical Harnesses**
- Electrical Connectors**
- Fuel Caps**
- Oil Caps & Dipsticks**
- Grease Fittings**
- Water Pumps**
- Wiper Blades**
- Engine Heaters**
- Link Cat's Eye®**
- Hub Caps, Axilok® & Securex®**
- Flitz**
- MAXXGreen**

## Trailer Cable - Flat Gray Jacket



Sloan No.	AWG Size	No. of Conductors	Stranding	O.D.	Colors		Length
422485	2@10	2	---	---	BK	W	100'
422486	2@12	2	---	---	BK	W	100'
422478	2@14	2	---	---	BK	W	1000'
422487	2@16	2	---	---	BK	W	100'
422488	3@14	3	---	---	Y	BN GN	100'
422489	3@16	3	---	---	Y	BN GN	100'
422480	3@14	3	---	---	BK	W R	500'
422490	4@14	4	---	---	Y	BN GN W	100'
422491	4@16	4	---	---	Y	BN GN W	100'

## Trailer Cable - Yellow ISO



Sloan No.	AWG Size	No. of Conductors	Stranding	O.D.	Colors				Length
*422472 (ISO)	4@12 2@10 1@8	4 2 1	168 104 65	.700	BK	BN	GN	Y	50'
					R	BL			
					W				
*422473 (ISO)	4@12 2@10 1@8	4 2 1	168 104 65	.700	BK	BN	GN	Y	100'
					R	BL			
					W				
*422474 (ISO)	4@12 2@10 1@8	4 2 1	168 104 65	.700	BK	BN	GN	Y	250'
					R	BL			
					W				
*422475 (ISO)	4@12 2@10 1@8	4 2 1	168 104 65	.700	BK	BN	GN	Y	500'
					R	BL			
					W				

# Wire & Cable



## Trailer Cable - Green Jacket (ABS)



Sloan No.	AWG Size	No. of Conductors	Stranding	O.D.	Colors	Length
422310	4@12	4	65	.700	BK BN GN Y	50'
	2@10	2	104		R BL	
	1@8	1	168		W	
422311	4@12	4	65	.700	BK BN GN Y	100'
	2@10	2	104		R BL	
	1@8	1	168		W	
422312	4@12	4	65	.700	BK BN GN Y	250'
	2@10	2	104		R BL	
	1@8	1	168		W	
422313	4@12	4	65	.700	BK BN GN Y	500'
	2@10	2	104		R BL	
	1@8	1	168		W	
422314	4@12	4	65	.700	BK BN GN Y	1000'
	2@10	2	104		R BL	
	1@8	1	168		W	

## Frame Clips

Sloan No.	Description
492200	3/16"
492201	1/4"
492202	3/8"



## Parallel Wire

Sloan No.	Length	Cond. Gauge	Colors
422494	100'	3 / 14 Ga.	Y BN GN
422495	100'	3 / 16 Ga.	Y BN GN
422496	100'	4 / 12 Ga.	Y BN GN W
422497	100'	4 / 14 Ga.	Y BN GN W
422498	100'	4 / 16 Ga.	Y BN GN W

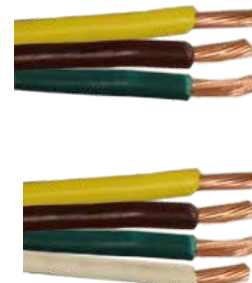

- Tramec
- Rubber Hose Assemblies
- Coiled Air Assemblies
- 3-in-1 & 4-in-1 Wraps
- Bulk Hose
- Air Compressor Discharge Hose Assemblies
- Quick Fix™
- Air Hose Accessories
- Hose Clamps
- Gladhands & Accessories
- Air Tanks
- Drain Valves
- Ground Plugs
- Truck Valves
- Selector Valves
- Brass Fittings
- Hose & Tube Chart
- Dash Control Valves
- Air Brake Valves
- Air Accessory Valves
- Air Cylinders
- Switches & Toggles
- Plugs, Sockets & Cables
- RV Plugs & Sockets
- Wire & Cable**
- Electrical Harnesses
- Electrical Connectors
- Fuel Caps
- Oil Caps & Dipsticks
- Grease Fittings
- Water Pumps
- Wiper Blades
- Engine Heaters
- Link Cat's Eye®
- Hub Caps, Axilok® & Securex®
- Flitz
- MAXXGreen

## Jacketed Parallel Primary Wire - Type GPT

- Thermoplastic insulated wires are jacketed with a tough grey PVC jacket.
- Parallel construction is common for use with trailers and vehicles where space is limited.
- Meets J1128 type GPT.



Sloan No.	AWG Size	No. of Conductors	Stranding	Nom. Cable O.D. (Inches)	Colors	Length
422240	14	2	19	.163 x .286	BN W	250'

## 300 Volt Portable Power Cable - Type SJE00-WA

- Greater mechanical strength, lighter weight, more resistant to low temperatures, heat, aging, abrasion, chemicals, oil, ozone and water.
- Temperature rating is from -70°C to +105°C.
- Meets UL, CSA and OSHA standards.



Sloan No.	AWG Size	No. of Conductors	Bare Cu Stranding	Conductor *Ampacity	Nom. O.D. (Inches)	Length
422271	14	2	41 x 30	18	.339	250'
422272	14	3	41 x 30	15	.360	250'

\*Ampacity ratings are based on copper conductor temp. at 90°C and ambient temp. at 40°C.

## Polyethylene Split Loom

- Split seam feature allows for easy wire insertion and service.
- Excellent for high-heat, high-abrasion, flexible applications. UV stabilized.
- Will not support combustion.

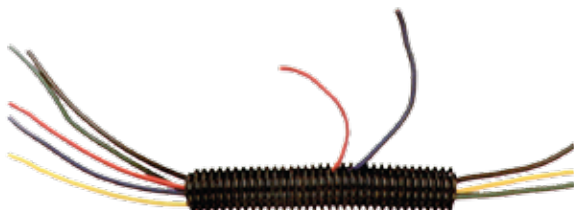

Sloan No.	I.D.	Length	Color
422415	1/4"	100 ft.	BK
422416	3/8"	100 ft.	BK
422417	1/2"	100 ft.	BK
422418	5/8"	100 ft.	BK
422419	3/4"	100 ft.	BK
422420	1"	100 ft.	BK
422636	1-1/4"	50 ft.	BK
422637	1-1/2"	50 ft.	BK
422638	2"	50 ft.	BK

CIRCUIT IDENTIFICATION	
ATS Color Code	Circuit
White	Ground return
Black	Clearance, side marker, and ident. lamps
Yellow	Left turn signal & hazard signal
Red	Stop lamp & anti-lock devices
Green	Right turn signal & hazard signal
Brown	Tail and license plate lamps
Blue	Auxiliary circuit/ABS power

WIRE GAUGE SELECTION CHART											
12-Volt System		Total Length of Cable in Circuit from Battery to Most Distant Lamp									
AMPS (App.)	Candle Power	2.5 ft. Ga.	5 ft. Ga.	10 ft. Ga.	20 ft. Ga.	30 ft. Ga.	40 ft. Ga.	50 ft. Ga.	60 ft. Ga.	80 ft. Ga.	100 ft. Ga.
1	6	20	20	20	20	20	20	20	20	20	18
1.5	10	20	20	20	20	20	20	20	20	18	18
2	16	20	20	20	20	20	20	18	18	16	16
3	24	20	20	20	20	20	18	18	16	16	14
4	30	20	20	20	20	18	16	16	16	14	12
5	40	20	20	20	18	18	16	14	14	12	12
6	50	20	20	20	18	16	16	14	14	12	12
7	60	20	20	20	18	16	14	14	12	12	10
8	70	20	20	20	16	16	14	12	12	10	10
10	80	20	20	18	16	14	12	12	12	10	10
11	90	20	20	18	16	14	12	12	10	10	8
12	100	20	20	18	16	14	12	12	10	10	8
15	120	20	20	18	14	12	12	10	10	8	8
18	140	20	20	16	14	12	10	10	8	8	8
20	160	20	18	16	12	12	10	10	8	8	6
22	180	20	18	16	12	10	10	8	8	8	6
24	200	20	18	16	12	10	10	8	8	6	6
36		20	16	14	10	8	8	8	6	6	4
50		18	16	12	10	8	6	6	4	4	2
100		14	12	10	6	4	4	2	2	1	0
150		14	10	8	4	2	2	1	0	00	000
200		12	8	6	4	2	1	0	00	000	0000

**NOTE:** This chart is based upon a 10% maximum voltage drop. For 5% voltage drop, use double the measured wire length. When mechanical strength is a factor, use next larger wire gauge.

- Tramec
- Rubber Hose Assemblies
- Coiled Air Assemblies
- 3-in-1 & 4-in-1 Wraps
- Bulk Hose
- Air Compressor Discharge Hose Assemblies
- Quick Fix™
- Air Hose Accessories
- Hose Clamps
- Gladhands & Accessories
- Air Tanks
- Drain Valves
- Ground Plugs
- Truck Valves
- Selector Valves
- Brass Fittings
- Hose & Tube Chart
- Dash Control Valves
- Air Brake Valves
- Air Accessory Valves
- Air Cylinders
- Switches & Toggles
- Plugs, Sockets & Cables
- RV Plugs & Sockets
- Wire & Cable**
- Electrical Harnesses
- Electrical Connectors
- Fuel Caps
- Oil Caps & Dipsticks
- Grease Fittings
- Water Pumps
- Wiper Blades
- Engine Heaters
- Link Cat's Eye®
- Hub Caps, Axilok® & Securex®
- Flitz
- MAXXGreen

## Rear Sill Harness

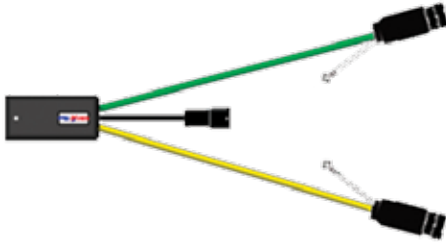

Sloan No.	Description
500304	24"-84" Rear Sill Harness
500305	50"-50" Rear Sill Harness

## Pigtail Harness



Sloan No.	Description
500400	Incandescent (2)S/T/T, (1) Marker
500401	Incandescent (2)S/T/T, (8) Bullet Connectors
500402	Incandescent (3)S/TT, (1) Marker
500403	Incandescent (3)S/T/T, (8) Bullet Connectors
500500	LED (2)S/T/T, (1) Marker
500501	LED (2)S/TT, (8) Bullet Connectors
500502	LED (3)S/T/T, (1) Marker
500503	LED (3)S/T/T, (8) Bullet Connectors
500600	Male Pin (2)S/T/T, (1) Marker
500601	Male Pin (2)S/T/T, (8) Bullet Connectors
500602	Male Pin (3)S/T/T, (1) Marker
500603	Male Pin (3)S/T/T, (8) Bullet Connectors

## Bar Lamp Harness



Sloan No.	Description
500700	3' Barlamp/License Harness
500701	3' Barlamp Harness
500702	19' Barlamp/License Harness
500703	19' Barlamp Harness

# Electrical Harnesses

## Main Harness

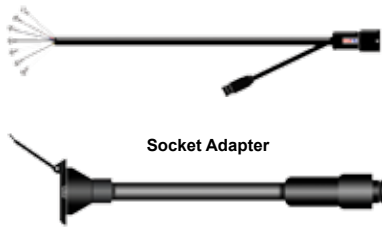

Sloan No.	Description
500130*	30' Main ABS Harness
500140	40' Main ABS Harness
500150	50' Main ABS Harness
500160	60' Main ABS Harness
500017	Socket Adapter (w/ 30' doubles)

\* When buying for a double trailer it is recommended that you purchase a socket adapter (500017).

## Mid-Turn Harness



Sloan No.	Description
500204*	24"-84" Center Pigtail/Turn Harness
500205*	24"-84" Center Pigtail/Turn Harness w/ Bullet Conn.
500206*	60"-60" Center Pigtail/Turn Harness
500207	60"-60" Pigtail/Turn Harness w/ Bullet Conn.
500300	25' S/T/T Lead
500301	25' Pigtail/Turn Extension Harness

\* When purchasing a 40', 50', 60' ABS Harness it is recommended that you purchase a center turn harness (500204, 500205, 500206).

## Jumper Harness



Sloan No.	Description
500200	5' Pigtail/Clearance Lamp Adapter
500201	5' Pigtail Adapter Jumper
500202	16' Pigtail/Clearance Lamp Adapter
500203	16' Pigtail Adapter Jumper
500800	8" Pigtail/Clearance Lamp Adapter

## ABS Harness



Sloan No.	Description
500302	12" ABS Adapter
500303	11' ABS Adapter

- Tramec
- Rubber Hose Assemblies
- Coiled Air Assemblies
- 3-in-1 & 4-in-1 Wraps
- Bulk Hose
- Air Compressor Discharge Hose Assemblies
- Quick Fix™
- Air Hose Accessories
- Hose Clamps
- Gladhands & Accessories
- Air Tanks
- Drain Valves
- Ground Plugs
- Truck Valves
- Selector Valves
- Brass Fittings
- Hose & Tube Chart
- Dash Control Valves
- Air Brake Valves
- Air Accessory Valves
- Air Cylinders
- Switches & Toggles
- Plugs, Sockets & Cables
- RV Plugs & Sockets
- Wire & Cable
- Electrical Harnesses
- Electrical Connectors
- Fuel Caps
- Oil Caps & Dipsticks
- Grease Fittings
- Water Pumps
- Wiper Blades
- Engine Heaters
- Link Cat's Eye®
- Hub Caps, Axilok® & Securex®
- Flitz
- MAXXGreen



## Lamp Pigtail

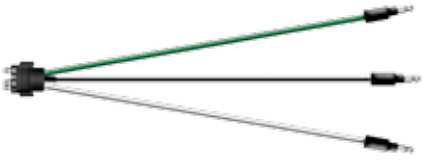

Sloan No.	Description
500801	Incandescent S/T/T Pigtail w/ (3) Bullet Connectors
500802	Truck-Lite LED Lamp S/T/T Pigtail w/ (3) Bullet Conn.
500803	Grote Male Pin S/T/T Pigtail w/ (3) Bullet Connectors

## 19 Series Lamp Pigtail



Sloan No.	Description
500002	8" Male Pin Marker Pigtail w/ (2) Bullet Connectors

## LED Marker Lamp Pigtail



Sloan No.	Description
500009	6" LED Marker Pigtail w/ (2) Bullet Connectors

## 10, 15 & 30 Series Lamp Pigtails



Sloan No.	Description
500001	8" Pigtail w/ (2) Bullet Connectors
500010	8" Pigtail (1) Ring, (1) Blunt Cut

## Male Pin Thin Line Pigtails



Sloan No.	Description
500003	8" Male Pin Thin Line w/ (2) Bullet Connector

## 40 Series Lamp Pigtail w/ Splash Guard



Sloan No.	Description
500008	8" S/T/T Pigtail with 90° plug-in, (3) Bullet Connectors
500013	8" S/T/T Pigtail with 90° plug-in, (1) Ring, (2) Blunt Cut

## 40 Series Lamp Pigtail



Sloan No.	Description
500006	12" Incandescent Aux Pigtail, (1) Bullet, (1) Ring
500007	12" Incandescent S/T/T, (3) Bullet Connectors
500011	11" Incandescent Aux. Pigtail (1) Ring, (1) Blunt Cut
500012	11" S/T/T Pigtail (1) Ring, (2) Blunt Cut

## AMP Style Connectors



Sloan No.	Description
500014	8" AMP Style (2) Bullet Connectors
500015	8" AMP Style (3) Bullet Connectors
500016	8" AMP Style (1) Ring, (1) Bullet

## Male Pin Marker Lamp Pigtail



Sloan No.	Description
500004	12" Male pin Marker Pigtail w/ (1) Ring, (1) Bullet
500005	8" Male Pin Marker Pigtail w/ (2) Bullet

- Tramec
- Rubber Hose Assemblies
- Coiled Air Assemblies
- 3-in-1 & 4-in-1 Wraps
- Bulk Hose
- Air Compressor Discharge Hose Assemblies
- Quick Fix™
- Air Hose Accessories
- Hose Clamps
- Gladhands & Accessories
- Air Tanks
- Drain Valves
- Ground Plugs
- Truck Valves
- Selector Valves
- Brass Fittings
- Hose & Tube Chart
- Dash Control Valves
- Air Brake Valves
- Air Accessory Valves
- Air Cylinders
- Switches & Toggles
- Plugs, Sockets & Cables
- RV Plugs & Sockets
- Wire & Cable
- Electrical Harnesses
- Electrical Connectors
- Fuel Caps
- Oil Caps & Dipsticks
- Grease Fittings
- Water Pumps
- Wiper Blades
- Engine Heaters
- Link Cat's Eye®
- Hub Caps, Axilok® & Securex®
- Flitz
- MAXXGreen

# Electrical Connectors

## Crimp 'N Seal® Waterproof Heat Shrink Connectors

- Crimp 'N Seal® waterproof connectors provide an environmental seal.
- Tough polymer jacket shrinks while simultaneously activating the adhesive in the tubing to completely encapsulate the connection.

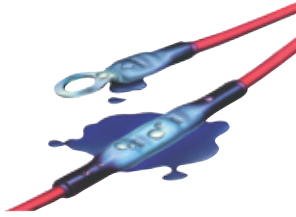

### Easy Installation Steps:

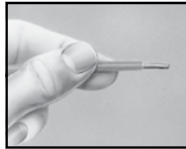

1. STRIP

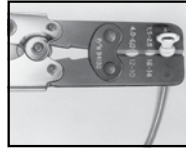

2. CRIMP

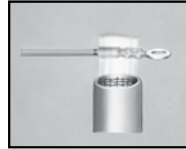

3. HEAT

### Accessories Available:

#### CRIMP 'N SEAL® Splice Kit



#### 422212 Kit Includes:

- 422200 Crimping Tool
- 15 422015 Red Splices
- 25 422016 Blue Splices
- 10 422017 Yellow Splices

#### CRIMP 'N SEAL® Wiring Kit



#### 422213 Kit Includes:

- 422199 Crimping Tool
- 80 piece assortment of most popular rings, forks & quick disconnect terminals.

#### CONTROLLED-CYCLE Crimping Tool



- Compound Action
- Color Coded Die Nest

Sloan No.	Wire Range	Handle Color
422200	22-10	blue

Electrical Products

## Forks

Wire Range	Stud Size	Crimp 'N Seal (non-locking)	†Crimp 'N Seal (locking)	Nylon (locking)	Vinyl (locking)	Nylon (non-locking)	Vinyl (non-locking)
22-18	6	422363	---	422440	422050	---	422577
22-18	8	422364	422371	422441	422049	---	---
22-18	10	422365	422372	422442	422048•	422542	---
16-14	6	422366	---	422443	422053•	---	422565
16-14	8	422367	422373	422444	422052•	---	---
16-14	10	422368	422374	422445	422051•	422548	422564
12-10	8	422369	422375	422446	422055	---	---
12-10	10	422370	422376	422447	422054•	422556	---
12-10	1/4	---	422377	---	---	---	---

†Not UL or CSA Listed



Crimp 'N Seal (Non-Locking)



Crimp 'N Seal (Locking)



Nylon (Locking)



Nylon (Non-Locking)



Vinyl (Locking)



Vinyl (Non-Locking)

# Electrical Connectors



## Rings

Wire Range	Stud Size	Crimp 'N Seal	Nylon	Vinyl	Brazed	Heat Shrink	Solder & Seal
22-18	6	---	422421	422031•	---	422535	---
22-18	8	422018•	422422	422030•	---	---	---
22-18	10	422019•	422423	422029•	---	---	---
22-18	5/16	---	422576	---	---	---	---
22-18	1/4	---	422424	422028•	---	422536	---
16-14	6	422020•	422425	422037•	---	---	---
16-14	8	422000•	422426	422036•	---	---	422544
16-14	10	422001•	422427	422035•	---	---	422545
16-14	1/4	422002•	422428	422034•	---	---	422546
16-14	5/16	422003•	422429	422033•	---	---	---
16-14	3/8	422004•	422430	422032•	---	---	422547
12-10	6	---	422581	---	---	---	---
12-10	8	422005•	422431	422043	---	---	---
12-10	10	422006•	422432	422042•	---	---	422552
12-10	1/4	422007	422433	422041•	---	---	422553
12-10	5/16	422008•	422434	422040•	---	---	---
12-10	3/8	422009•†	422435	422039•	---	---	422554
12-10	1/2	422010•	422436	422038•	---	---	422555
8	10	---	---	422575	422537	---	---
8	1/4	---	422437	422025•	---	422538	---
8	3/8	---	422438	422026•	---	422539	---
8	1/2	---	422439	422027•	---	422540	---
6	1/4	---	---	422571	---	---	---
6	5/16	---	---	422572	---	---	---
6	1/2	---	---	422573	---	---	---
4	1/4	---	---	---	422517	---	---
4	3/8	---	---	---	422518	---	---
4	1/2	---	---	---	422519	---	---
2	3/8	---	---	---	422520	---	---
2	1/2	---	---	---	422521	---	---
1/0	3/8	---	---	---	422522	---	---
1/0	1/2	---	---	---	422523	---	---
2/0	3/8	---	---	---	422513	---	---
2/0	1/2	---	---	---	422514	---	---
3/0	3/8	---	---	---	422515	---	---
3/0	1/2	---	---	---	422516	---	---

†Not CSA Listed



Crimp 'N Seal



Nylon



Vinyl



Brazed



Heat Shrink



Solder & Seal

- Tramec
- Rubber Hose Assemblies
- Coiled Air Assemblies
- 3-in-1 & 4-in-1 Wraps
- Bulk Hose
- Air Compressor Discharge Hose Assemblies
- Quick Fix™
- Air Hose Accessories
- Hose Clamps
- Gladhands & Accessories
- Air Tanks
- Drain Valves
- Ground Plugs
- Truck Valves
- Selector Valves
- Brass Fittings
- Hose & Tube Chart
- Dash Control Valves
- Air Brake Valves
- Air Accessory Valves
- Air Cylinders
- Switches & Toggles
- Plugs, Sockets & Cables
- RV Plugs & Sockets
- Wire & Cable
- Electrical Harnesses
- Electrical Connectors
- Fuel Caps
- Oil Caps & Dipsticks
- Grease Fittings
- Water Pumps
- Wiper Blades
- Engine Heaters
- Link Cat's Eye®
- Hub Caps, Axilok® & Securex®
- Flitz
- MAXXGreen

## Butt Splices

Wire Gauge	Crimp 'N Seal(Brazed)	Crimp, Heat		Crimp, Shrink & Solder & Seal		
		Nylon	Vinyl	Shrink	Solder Seal	
22-18	422015•	422448	422047•	---	422559	422543
16-14	422016•	422449	422046•	---	422560	422549
12-10	422017•	422450	422045•	---	---	422557
8	---	422451	422044•	422541	---	---
6	---	422574	---	---	---	---



Nylon



Nylon

Electrical Products

## Cool-Seal Connectors

**Simply Strip The Wire, Insert Into The Gel, And Crimp**

Sloan No.	Description
422720*	Cool-Seal 22-18 Ga. Butt Splice
422721*	Cool-Seal 16-14 Ga. Butt Splice
422722*	Cool-Seal 12-10 Ga. Butt Splice

\*Standard Pack Of 100

### A Heat-Less/Solderless Connection

Simply strip the wire and crimp, activating the sealant, to create an environmentally sealed connection. Requiring no heat, the Cool Seal will reduce overall costs by eliminating the need for torches or heat guns reducing the installation time, and improving productivity.



P/N 422720



P/N 422722

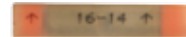

P/N 422721

## Bullets/Snap Plugs

Wire Range	Style	Stud Size	†Crimp 'N Seal	Nylon	Vinyl
22-18	Male	.157	---	422464	422578
22-18	Female	.157	---	422465	---
22-18	Union	.157	---	---	422580
22-18	Female	.180	---	---	422579
16-14	Male	.157	422023•	422466	422062•
16-14	Female	.157	422024•	422467	422063•
16-14	Female	.176	---	422562	422568
16-14	Male	.176	---	422563	422567
12-10	Male	.157	---	---	422583

†Not UL or CSA Listed



Nylon



Vinyl

# Electrical Connectors



## 3 & 4 Way Splices

Wire Range	Style	†Crimp 'N Seal	Vinyl
22-18	3 way	422378	---
22-18	4 way	422379	---
16-14	3 way	422380	422584
16-14	4 way	422381	422586
12-10	3 way	422382	422585
12-10	4 way	422383	422587

†Not UL or CSA Listed



## Quick Lock Connectors Vinyl

Sloan No.	Wire Range	Stud Size
422064•	tap	18-14



## Quick Disconnects

Wire Range	Style	†Crimp 'N Seal (insulated)	†Crimp 'N Seal (standard)	Nylon (insulated)	Nylon (standard)	Vinyl (insulated)	Vinyl (standard)
22-18	Male	422011•	422387	---	422458	---	422056
22-18	Female	422012•	422388	---	422459	---	422057
16-14	Male	422013•	422389	422454•	422460	---	422058•
16-14	Female	422014•	422390	422455•	422461	---	422059•
12-10	Male	422021•	422391	---	422462	422069	422060•
12-10	Female	422022•	422392	---	422463	422070	422061•

†Not UL or CSA Listed

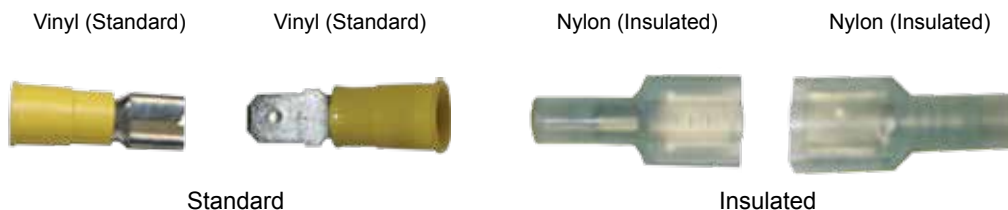

• Item is available packaged. Order with suffix - "P".

- Tramec
- Rubber Hose Assemblies
- Coiled Air Assemblies
- 3-in-1 & 4-in-1 Wraps
- Bulk Hose
- Air Compressor Discharge Hose Assemblies
- Quick Fix™
- Air Hose Accessories
- Hose Clamps
- Gladhands & Accessories
- Air Tanks
- Drain Valves
- Ground Plugs
- Truck Valves
- Selector Valves
- Brass Fittings
- Hose & Tube Chart
- Dash Control Valves
- Air Brake Valves
- Air Accessory Valves
- Air Cylinders
- Switches & Toggles
- Plugs, Sockets & Cables
- RV Plugs & Sockets
- Wire & Cable
- Electrical Harnesses
- Electrical Connectors**
- Fuel Caps
- Oil Caps & Dipsticks
- Grease Fittings
- Water Pumps
- Wiper Blades
- Engine Heaters
- Link Cat's Eye®
- Hub Caps, Axilok® & Securex®
- Flitz
- MAXXGreen

## Wire End Caps

Sloan No.	Ga. Size
422569	12
422570	14



## Solder & Seal Quick Connect

Sloan No.	Gauge	Description
422550	16-14	Male
422551	16-14	Female

Solder/Seal



## Nylon Cable Ties

Sloan No.	Description	Length	Tensile Strength
422071	natural	4"	18 lbs.
422072	natural	5"	30 lbs.
422073	natural	8"	50 lbs.
422074	natural-mountable	7"	50 lbs.
422075	natural	14"	50 lbs.
422076	natural	14"	120 lbs.
422077	uv black	4"	18 lbs.
422078	uv black	5"	30 lbs.
422079	uv black	8"	50 lbs.
422080	uv black	14"	50 lbs.
422081	uv black	14"	120 lbs.
422588	natural	11"	50 lbs.
422589	black	11"	50 lbs.
422590	natural-releasable	10-1/2"	---
422591	black-resealable	10-1/2"	---

• Item is available packaged. Order with suffix - "P".



## Silicone Self-Fusing Tape

Silicone Self-Fusing Tape is an advanced line of electrical connectivity products. It is ideal for almost any application requiring a waterproof seal and can even be applied underwater. Typical usages include marine connections, battery terminals, automotive hose systems, color coding, garden hoses, outside plant cable splices and grip enhancements.

Sloan No.	Description
421808	Silicone Self-Fusing Tape, Red, 1" x 20'
421809	Silicone Self-Fusing Tape, Black, 1" x 20'
421810	Silicone Self-Fusing Tape, Blue, 1" x 20'



### Benefits

- Revolutionary Alternative to Heat Shrink Tubing
- Forms a Permanent Moisture Tight Seal
- No Adhesive Residue Upon Removal
- Self Fusing and Begins Curing Immediately
- Can Be Applied Underwater
- Ideal for High Temperature Applications

# Electrical Connectors

## Heavy Wall Heat Shrink Tubing

- This FR grade tubing meets MIL Spec. 23053/15 rigid requirements for flame retardancy. This level of performance is now a requirement in many areas of the transportation industry.
- The tubing has a 3 to 1 shrink ratio. Application of heat causes an adhesive liner to melt as the tubing shrinks, forming intimate contact with all underlying surfaces and voids. This yields a watertight seal suitable for above and underground applications.
- The FR tubing is recommended for insulating splices and terminations. It is UL listed under the 486 D standard and meets CSA certification requirements.



Sloan No.	Length	I.D.	Wire Color	Wire Range	Max. Wall Thickness
422166	1.5"	.750	black	8-1	.105
422167	1.5"	.750	red	8-1	.105
422168	1.5"	1.100	black	2-4/0	.120
422169	1.5"	1.100	red	2-4/0	.120
422170	6"	.300	black	18-14	.060
422171	6"	.400	black	14-6	.060
422172	6"	.750	black	8-1	.105
422173	6"	.750	red	8-1	.105
422174	6"	1.100	black	2-4/0	.120
422175	6"	1.100	red	2-4/0	.120
422595	48"	1.10	black	2-4/0	.080
422596	48"	1.10	clear	2-4/0	.080
422597	48"	1.10	red	2-4/0	.080

## Thin Wall Heat Shrink Tubing

- Thin wall heat shrink tubing is opaque tubing with a 2 to 1 shrink ratio. It can be used as electrical insulation over cable splices and terminations, and for wire harness covering, bundling and wire marker identification. It may also be easily assembled over components, connectors or other irregular shapes.
- Thin wall tubing products meet or exceed the requirements of MIL-1-23053D/5, Class I, II, and III, AMS 3636C and AMS 3637B, are UL recognized, and CSA certified.



Sloan No.	Length	I.D.	Wire Color	Wire Range	Max. Wall Thickness
422159	6"	1/8	red	22-18	.020
422160	6"	1/4	blue	16-14	.025
422161	6"	5/16	yellow	12-10	.025
422592	6"	.187	red	22-18	.047
422593	6"	.250	blue	16-14	.047
422594	6"	.312	yellow	12-10	.050

## Dual Wall Heat Shrink Tubing

- Polyolefin tubing can be used for sealing splices and terminals. In addition to weather proofing your connection, it also provides strain relief and vibration resistance.
- Dual wall is an economical alternative to heavy wall tubing in light duty applications.



Sloan No.	Length	I.D.	Wire Color	Wire Range	Max. Wall Thickness
422598	6"	.187	black	20-14	.040
422162	6"	3/8	black	12-6	.050
422163	6"	1/2	black	8-4	.055
422164	6"	1	black	2-4/0	.100
422165	6"	1	red	2-4/0	.100

- Tramec**
- Rubber Hose Assemblies**
- Coiled Air Assemblies**
- 3-in-1 & 4-in-1 Wraps**
- Bulk Hose**
- Air Compressor Discharge Hose Assemblies**
- Quick Fix™**
- Air Hose Accessories**
- Hose Clamps**
- Gladhands & Accessories**
- Air Tanks**
- Drain Valves**
- Ground Plugs**
- Truck Valves**
- Selector Valves**
- Brass Fittings**
- Hose & Tube Chart**
- Dash Control Valves**
- Air Brake Valves**
- Air Accessory Valves**
- Air Cylinders**
- Switches & Toggles**
- Plugs, Sockets & Cables**
- RV Plugs & Sockets**
- Wire & Cable**
- Electrical Harnesses**
- Electrical Connectors**
- Fuel Caps**
- Oil Caps & Dipsticks**
- Grease Fittings**
- Water Pumps**
- Wiper Blades**
- Engine Heaters**
- Link Cat's Eye®**
- Hub Caps, Axilok® & Securex®**
- Flitz**
- MAXXGreen**



## Right Elbow Post Top



Sloan No.	Cable Size	Polarity	Tool Die Code
422089	1/0	negative	black E-A
422088	1/0	positive	black E-A
422091	2/0	negative	orange A-C
422090	2/0	positive	orange A-C
422093	3/0	negative	purple A-B
422092	3/0	positive	purple A-B
422506	4/0	negative	yellow A-A
422507	4/0	positive	yellow A-A

Note: Items are tin plated and color coded for ease of installation.

## Flag Post Top



Sloan No.	Cable Size	Polarity	Tool Die Code
422105	1/0	negative	black E-A
422106	1/0	positive	black E-A
422107•	2/0	negative	orange A-C
422108•	2/0	positive	orange A-C
422109•	3/0	negative	purple A-B
422110•	3/0	positive	purple A-B
422111	4/0	negative	yellow A-A
422112	4/0	positive	yellow A-A

Note: Items are tin plated and color coded for ease of installation.

## Left Elbow Post Top



Sloan No.	Cable Size	Polarity	Tool Die Code
422083	1/0	negative	black E-A
422082	1/0	positive	black E-A
422085	2/0	negative	orange A-C
422084	2/0	positive	orange A-C
422087	3/0	negative	purple A-B
422086	3/0	positive	purple A-B
422508	4/0	negative	yellow A-A
422509	4/0	positive	yellow A-A

Note: Items are tin plated and color coded for ease of installation.

## Straight Post Top



Sloan No.	Post Style	Ga.
422504	universal	6
422505	universal	1-2

## Post Top Battery Terminals

- Copper construction provides a low resistance connection.
- Cable size, polarity, and tool die codes are raised characters for increased legibility.
- Tin plated with color coding.
- For maximum durability, use with heavy wall heat shrink tubing in 1-1/2 inch pieces.



Sloan No.	Cable Size	Polarity	Tool Die Code
422094•	4	universal	green J-H
422096	1-2	negative	pink H-H
422095	1-2	positive	pink H-H
422098•	1/0	negative	black E-A
422097•	1/0	positive	black E-A
422100•	2/0	negative	orange A-C
422099•	2/0	positive	orange A-C
422102	3/0	negative	purple A-B
422101	3/0	positive	purple A-B
422104	4/0	negative	yellow A-A
422103	4/0	positive	yellow A-A

Note: Items are tin plated and color coded for ease of installation.

## Yellow Brass Solder Post Top Battery Terminals

- Lead plated for superior corrosion resistance.



### Straights - Lead Plated Stud Top

Sloan No.	Cable Size	Polarity
422131	3-4	universal
422133	1/0	negative
422134	1/0	positive
422135	2/0-3/0	negative
422136	2/0-3/0	positive
422143	marine terminal	positive
422144	marine terminal	negative

## Emergency - Lead Plated Yellow Brass Stud Top



Sloan No.	Description	Cable Size	Polarity
422142•	heavy duty	6-3/0	universal
422128	automotive*	6-2/0	universal

\*Note: Cast lead /no plating.

## Flags - Lead Plated (split barrels) Stud Top



Sloan No.	Cable Size	Polarity
422137	1-2	universal
422138	1/0	negative
422139	1/0	positive
422140	2/0-3/0	negative
422141	2/0-3/0	positive

- Tramec**
- Rubber Hose Assemblies**
- Coiled Air Assemblies**
- 3-in-1 & 4-in-1 Wraps**
- Bulk Hose**
- Air Compressor Discharge Hose Assemblies**
- Quick Fix™**
- Air Hose Accessories**
- Hose Clamps**
- Gladhands & Accessories**
- Air Tanks**
- Drain Valves**
- Ground Plugs**
- Truck Valves**
- Selector Valves**
- Brass Fittings**
- Hose & Tube Chart**
- Dash Control Valves**
- Air Brake Valves**
- Air Accessory Valves**
- Air Cylinders**
- Switches & Toggles**
- Plugs, Sockets & Cables**
- RV Plugs & Sockets**
- Wire & Cable**
- Electrical Harnesses**
- Electrical Connectors**
- Fuel Caps**
- Oil Caps & Dipsticks**
- Grease Fittings**
- Water Pumps**
- Wiper Blades**
- Engine Heaters**
- Link Cat's Eye®**
- Hub Caps, Axilok® & Securex®**
- Flitz**
- MAXXGreen**

## Power Terminals

- Stamped from 99.9% ETP copper.
- Anti-rotational indents allow stacking and grips battery securely.

## Stud Top



Sloan No.	Cable Size	Polarity	Tool Die Code
422113	4	universal	gray J-H
422114	1-2	universal	pink H-H
422115	1/0	universal	black E-A
422116	2/0	universal	orange A-C
422120	3/0	universal	purple A-B
422117	4/0	universal	yellow A-A

Note: Items are tin plated and color coded for ease of installation.

## Power Splices (Flag) Stud Top



Sloan No.	Cable Size	Polarity	Tool Die Code
422118	1/0	universal	black E-A
422119	2/0	universal	orange A-C
422121	3/0	universal	purple A-B
422122	4/0	universal	yellow A-A

Note: Items are tin plated and color coded for ease of installation.

## Cast Terminals - Straights Stud Top



Sloan No.	Cable Size	Polarity	Tool Die Code
422393	4	universal	green J-H
422394	1-2	universal	pink H-H
422395	1/0	universal	black E-A
422396	2/0	universal	orange A-C
422397	3/0	universal	purple A-B
422398	4/0	universal	yellow A-A

Note: Items are tin plated and color coded for ease of installation.

## Cast Terminals - Splices (Flags) Stud Top



Sloan No.	Cable Size	Polarity	Tool Die Code
422399	1/0	universal	black E-A
422400	2/0	universal	orange A-C
422401	3/0	universal	purple A-B
422402	4/0	universal	yellow A-A

Note: Items are tin plated and color coded for ease of installation.

# Electrical Connectors

## Battery Terminals Side Mount



Sloan No.	Cable Size	Polarity	Tool Die Code
422403	4	universal	gray K-K
422404	2	universal	brown J-H
422405	1	universal	green J-H
422406	1/0	universal	pink H-H

Note: Items are tin plated.

## Side Terminal Charging Post



Sloan No.	Polarity
422524	negative
422525	positive

## Side Mount Bolts



Sloan No.	Description
422130	Side mount bolt, OEM, steel, zinc-plated
422123	Side mount bolt long with screw, steel, zinc-plated

## Nut and Bolt



Sloan No.	Description
422407	5/16-18 x 1 1/4" bolt & shoulder nut, steel, lead plated
422408	5/16-18 x 1 1/4" bolt & shoulder nut, steel, zinc plated
422409	5/16-18 x 1 1/2" bolt & shoulder nut, steel, lead plated
422410	5/16-18 x 1 1/2" bolt & shoulder nut, steel, zinc plated

## Stud Nuts Group 31 Batteries



Sloan No.	Description	Polarity
422124	black amodel	negative
422125	red amodel	positive
422126•	stainless steel	universal

## Stud to Post Convertor Solid Lead



Sloan No.	Description	Polarity
422129•	convertor	universal

- Tramec
- Rubber Hose Assemblies
- Coiled Air Assemblies
- 3-in-1 & 4-in-1 Wraps
- Bulk Hose
- Air Compressor Discharge Hose Assemblies
- Quick Fix™
- Air Hose Accessories
- Hose Clamps
- Gladhands & Accessories
- Air Tanks
- Drain Valves
- Ground Plugs
- Truck Valves
- Selector Valves
- Brass Fittings
- Hose & Tube Chart
- Dash Control Valves
- Air Brake Valves
- Air Accessory Valves
- Air Cylinders
- Switches & Toggles
- Plugs, Sockets & Cables
- RV Plugs & Sockets
- Wire & Cable
- Electrical Harnesses
- Electrical Connectors
- Fuel Caps
- Oil Caps & Dipsticks
- Grease Fittings
- Water Pumps
- Wiper Blades
- Engine Heaters
- Link Cat's Eye®
- Hub Caps, Axilok® & Securex®
- Flitz
- MAXXGreen

## Anti-Corrosion Rings

- Felt material helps protect both battery and battery terminal from corrosion.
- Color coded for polarity.
- Use with post top, stud top and side mount batteries.
- Comes in a package of 100 pcs. All rings are pre-applied with grease.



Sloan No.	Battery Type	Color/Polarity
422411	post top/stud top	green/negative
422412	post top/stud top	red/positive
422413	side mount	green/negative
422414	side mount	red/positive

## Power Lugs & Splices

- Increased wall thickness yields greater strength and conductivity.
- Tin plating offers corrosion resistance.
- Crimps with the same die setting as corresponding size battery terminal.

### Heavy Duty Power Lug



Sloan No.	Cable Size	Stud Size	Tool Die Code
422345	4	1/4"	green J-H
422346	4	5/16"	green J-H
422347	1-2	1/4"	pink H-H
422348	1-2	3/8"	pink H-H
422349	1/0	3/8"	black E-A
422350	1/0	1/2"	black E-A
422351	2/0	3/8"	orange A-C
422352	2/0	1/2"	orange A-C
422353	3/0	3/8"	purple A-B
422354	3/0	1/2"	purple A-B
422355	4/0	3/8"	yellow A-A
422356	4/0	1/2"	yellow A-A

Note: Items are tin plated and color coded for ease of installation.

### Heavy Duty Starter Lugs



Sloan No.	Stud Size	Gauge
422510	3/8"	4
422511	1/2"	4
422512	1/2"	1-2

# Electrical Connectors

## Heavy Duty Power Splices



Sloan No.	Cable Size	Tool Die Code
422357	4	green J-H
422358	1-2	pink H-H
422359	1/0	black E-A
422360	2/0	orange A-C
422361	3/0	purple A-B
422362	4/0	yellow A-A

## Cable Splices - Tin Plated



Sloan No.	Cable Size	Tool Die Code
422145	6	blue M-K
422146	4	gray K-K
422147	2	brown J-H
422148	1	green J-H
422149	1/0	pink H-H
422150	2/0	black E-A
422151	3/0	orange A-C
422152	4/0	purple A-B

## Starter Lugs - Light Duty



Sloan No. (unplated)	Cable Size	Stud Size	Tool Die Code
422176	6	1/4"	blue M-K
422177	6	5/16"	blue M-K
422178	4	1/4"	gray K-K
422179	4	5/16"	gray K-K
422180	2	5/16"	brown J-H
422181	2	3/8"	brown J-H
422182	1	5/16"	green J-H
422183•	1	3/8"	green J-H
422184	1/0	3/8"	pink H-H
422185	1/0	1/2"	pink H-H
422186•	2/0	3/8"	black E-A
422187•	2/0	1/2"	black E-A
422188•	3/0	3/8"	orange A-C
422189	3/0	1/2"	orange A-C
422190•	4/0	3/8"	purple A-B
422191•	4/0	1/2"	purple A-B

- Tramec
- Rubber Hose Assemblies
- Coiled Air Assemblies
- 3-in-1 & 4-in-1 Wraps
- Bulk Hose
- Air Compressor Discharge Hose Assemblies
- Quick Fix™
- Air Hose Accessories
- Hose Clamps
- Gladhands & Accessories
- Air Tanks
- Drain Valves
- Ground Plugs
- Truck Valves
- Selector Valves
- Brass Fittings
- Hose & Tube Chart
- Dash Control Valves
- Air Brake Valves
- Air Accessory Valves
- Air Cylinders
- Switches & Toggles
- Plugs, Sockets & Cables
- RV Plugs & Sockets
- Wire & Cable
- Electrical Harnesses
- Electrical Connectors**
- Fuel Caps
- Oil Caps & Dipsticks
- Grease Fittings
- Water Pumps
- Wiper Blades
- Engine Heaters
- Link Cat's Eye®
- Hub Caps, Axilok® & Securex®
- Flitz
- MAXXGreen

# Electrical Connectors

Electrical Products

## Solder Slugs



Sloan No.	Gauge	Color
422527	6	gray
422528	4	gray
422529	2	green
422530	1	pink
422531	1/0	black
422532	2/0	orange
422533	3/0	purple
422534	4/0	yellow

## Solder Flux



Sloan No.	Description
422526	Solder Flux

## Safe-Mate™ Industrial Battery Connectors

- High impact polycarbonate housing prevents breakage.
- Silver plated copper contacts deliver maximum current and long life.
- Contact marking provides step by step guide to installation.
- Universal Connector, (use as male or female end).



Sloan No.	Amp Rating	Housing Color	Cable Size	I.D. Contact
422192	50	gray	6	.221
422193	50	gray	12-10	.136
422194	175	gray	1/0	.437
422195	350	gray	2/0	.484



## Dust Covers

Sloan No.	Wire Range	Stud Size
422196	50	black
422197	175	black
422198	350	black

# Electrical Connectors

## Cross-Over Cables Post Top



Sloan No.	Length	Cable Size	Polarity
422157	8"	2/0	universal
422158	12"	2/0	universal

## Cross-Over Cables Stud Top



Sloan No.	Length	Cable Size	Polarity
422153	8"	1/0	negative
422154	8"	1/0	positive
422155	16"	1/0	negative
422156	16"	1/0	positive

## Ground Straps



Sloan No.	Length	Gauge
422639	12"	4
422640	18"	4

## Top Stud to Top Stud



Sloan No.	Length	Gauge
422629	12"	2/0
422630	15"	2/0
422631	18"	2/0
422633	8"	2/0

## Top Post to Top Post



Sloan No.	Length	Gauge
422619	9"	1
422620	12"	1
422627	10"	2/0

- Tramec
- Rubber Hose Assemblies
- Coiled Air Assemblies
- 3-in-1 & 4-in-1 Wraps
- Bulk Hose
- Air Compressor Discharge Hose Assemblies
- Quick Fix™
- Air Hose Accessories
- Hose Clamps
- Gladhands & Accessories
- Air Tanks
- Drain Valves
- Ground Plugs
- Truck Valves
- Selector Valves
- Brass Fittings
- Hose & Tube Chart
- Dash Control Valves
- Air Brake Valves
- Air Accessory Valves
- Air Cylinders
- Switches & Toggles
- Plugs, Sockets & Cables
- RV Plugs & Sockets
- Wire & Cable
- Electrical Harnesses
- Electrical Connectors**
- Fuel Caps
- Oil Caps & Dipsticks
- Grease Fittings
- Water Pumps
- Wiper Blades
- Engine Heaters
- Link Cat's Eye®
- Hub Caps, Axilok® & Securex®
- Flitz
- MAXXGreen



# Electrical Connectors

Electrical Products

## Switch to Starter



Sloan No.	Length	Gauge
422604	12"	4
422605	15"	4
422606	24"	4
422607	36"	4
422608	40"	4
422621	10"	1
422622	12"	1
422623	15"	1
422624	18"	1
422625	24"	1
422626	7"	1
422628	12"	2/0
422632	8"	2/0

## Top Post to Solenoid

Sloan No.	Length	Gauge
422599	12"	4
422600	15"	4
422601	19"	4
422602	24"	4
422603	30"	4
422609	12"	1
422610	16"	1
422611	19"	1
422612	22"	1
422613	25"	1
422614	30"	1
422615	37"	1
422616	48"	1
422617	65"	1
422618	9"	1



## Hand Tools

Sloan No.	Description	Length	Weight
422199•	Crimper, cutter, stripper	9-3/8"	8.9 OZ.
422200•	Compound action controlled cycle tool. Elliptical shaped. Nests for crimping insulated terminals. Blue handles. Wire range 22-10.	9-1/8"	12.4 OZ.
422201	18 TO 10 AWG stripper cuts up to 6 AWG.	6-3/4"	5.3 OZ.
422202	Rotary cable stripper 8 AWG-400 MCM	5-3/8"	4.9 OZ.



422199



422200



422202

# Electrical Connectors

## Butane Power Torch

- Stands alone for hand free operation.
- Self-igniting torch uses refillable butane fuel.
- Tank capacity provides approximately 70 minutes of usage.



Sloan No.	Description	Length	Weight
422206	Butane power torch	6"	14 OZ.

## Electric Heat Gun

- 2 temperature settings of 750°F and 1100°F.
- No cool down time required.
- Fold down stand for hands free operation.



Sloan No.	Description	Length	Weight
422205	Electric heat gun 115 volts AC	9-3/4"	1.9 LBS.

## Compact Crimping Tool



Sloan No.	Description	Length	Weight
422208	Hammer type crimping tool	3-3/4"	1.5 LBS.

## Solder & Seal Kit

Sloan No.	Description
422561	Solder & Seal Kit

- Includes most popular styles and sizes
- Rings
  - Butt Connectors
  - Quick Connects
  - 3 sizes of heat shrink tubing
  - Heat gun



Qty.	Sloan No.	Qty.	Sloan No.
1	422206	1	422592
1	422593	1	422594
10	422543	10	422545
10	422549	10	422547
10	422546	10	422551
10	422550	10	422552
10	422557	10	422554
10	422553		

## Cable Tie Accessories



Sloan No.	Description
422210•	Cable tie installation tool
422211	Cable tie kit
	Includes cable tie tool, uv black 8" ties (50 pcs), natural 5 1/2" ties (100 pcs), mounting bases (10 pcs).

- Tramec
- Rubber Hose Assemblies
- Coiled Air Assemblies
- 3-in-1 & 4-in-1 Wraps
- Bulk Hose
- Air Compressor Discharge Hose Assemblies
- Quick Fix™
- Air Hose Accessories
- Hose Clamps
- Gladhands & Accessories
- Air Tanks
- Drain Valves
- Ground Plugs
- Truck Valves
- Selector Valves
- Brass Fittings
- Hose & Tube Chart
- Dash Control Valves
- Air Brake Valves
- Air Accessory Valves
- Air Cylinders
- Switches & Toggles
- Plugs, Sockets & Cables
- RV Plugs & Sockets
- Wire & Cable
- Electrical Harnesses
- Electrical Connectors
- Fuel Caps
- Oil Caps & Dipsticks
- Grease Fittings
- Water Pumps
- Wiper Blades
- Engine Heaters
- Link Cat's Eye®
- Hub Caps, Axilok® & Securex®
- Flitz
- MAXXGreen

## Heavy Duty Cable Cutters

- Machined blade surfaces eliminate nicking and binding.
- Precision edge design provides for easy cutting.

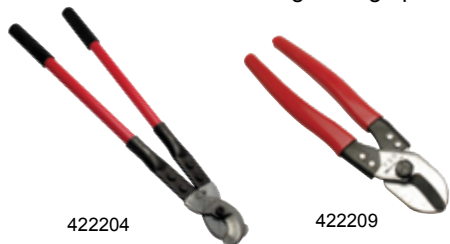

Sloan No.	Description	Length	Weight
422204	Cable cutter, 350 MCM maximum	16-1/2"	3.5 LBS.
422209•	Compact cable cutter, 2/0 maximum	7-3/8"	12 OZ.

## Professional Crimping Tool



Sloan No.	Description	Length	Weight
422207	Crimp tool for battery terminals, lugs and connectors cable sizes 8 thru 4/0.	25"	5.9 LBS.

- Compound action exerts maximum force for fast, reliable crimps.
- One screw adjustment provides easy calibration to compensate for die wear.
- Diamond shape crimp compresses all strands together to form a solid mass of copper, assuring a low resistance connection.
- Quick release lever allows tool to open at any time.

## Crimp 'N Seal® Waterproof Wiring Kit



Sloan No.	Description
422213	80 piece assortment of most popular rings, forks and quick disconnect terminals. Includes 422199 multi-purpose tool.

## Crimp 'N Seal® Waterproof Wiring Kit



Sloan No.	Description
422214	500 piece assortment of the most popular rings, forks, and quick disconnect terminals. Includes crimping tool 422200, portable butane torch (422206), cable tie (422210), and 100 cable ties (422079).

## Crimp 'N Seal® Splice Kit



Sloan No.	Description
422212	Includes 15 red butt splices (22-18), 25 blue butt splices (16-14), and 10 yellow butt slices (12-10), along with crimping tool (422200).

Electrical Products

# Electrical Connectors



## Sloan Electrical Spin Display Rack

- 4 blue panels with plan-o-gram makes product arrangement simple.
- Attractive Sloan header sign.
- Includes 79 6" hook pegs.
- Available fully stocked with packaged electrical product or as spin rack only.
- Includes reorder form to make restocking easy.

### Electrical Package

- Clear bag for easy part identification.
- Label includes Sloan part number, part description, quantity and competitor cross references.



Spin Rack Empty	Spin Rack Assortment
421998	421999



## Sloan Electrical Display Spin Rack Assortment

- Packaged in clear bag for easy part identification.
- Bag label includes Sloan part number, part description, quantity and competitor cross references.
- Receive a 421998 rack with every assortment purchase.

### 421999 Electrical Display Spin Rack Assortment

Qty.	Sloan No.	Qty.	Sloan No.	Qty.	Sloan No.	Qty.	Sloan No.
1	421998	300	422033P	150	422060P	12	422109P
60	422001P	300	422034P	150	422061P	12	422110P
60	422002P	300	422035P	300	422062P	60	422126P
60	422003P	300	422036P	150	422063P	30	422129P
60	422004P	300	422037P	60	422064P	12	422142P
60	422006P	150	422038P	600	422071P	30	422183P
60	422007P	150	422039P	600	422073P	30	422186P
60	422008P	150	422040P	600	422075P	30	422187P
60	422009P	150	422041P	300	422076P	30	422188P
60	422014P	150	422042P	600	422077P	30	422190P
60	422015P	60	422044P	600	422078P	30	422191P
60	422016P	150	422045P	600	422079P	6	422199P
60	422017P	300	422046P	600	422080P	6	422200P
60	422025P	300	422047P	300	422081P	6	422209P
60	422026P	300	422048P	12	422094P	6	422210P
60	422027P	300	422051P	12	422097P	150	422454P
300	422028P	300	422052P	12	422098P	150	422455P
300	422029P	300	422053P	12	422099P		
300	422030P	150	422054P	12	422100P		
300	422031P	300	422058P	12	422107P		
300	422032P	300	422059P	12	422108P		

- Tramec
- Rubber Hose Assemblies
- Coiled Air Assemblies
- 3-in-1 & 4-in-1 Wraps
- Bulk Hose
- Air Compressor Discharge Hose Assemblies
- Quick Fix™
- Air Hose Accessories
- Hose Clamps
- Gladhands & Accessories
- Air Tanks
- Drain Valves
- Ground Plugs
- Truck Valves
- Selector Valves
- Brass Fittings
- Hose & Tube Chart
- Dash Control Valves
- Air Brake Valves
- Air Accessory Valves
- Air Cylinders
- Switches & Toggles
- Plugs, Sockets & Cables
- RV Plugs & Sockets
- Wire & Cable
- Electrical Harnesses
- Electrical Connectors**
- Fuel Caps
- Oil Caps & Dipsticks
- Grease Fittings
- Water Pumps
- Wiper Blades
- Engine Heaters
- Link Cat's Eye®
- Hub Caps, Axilok® & Securex®
- Flitz
- MAXXGreen

## Aluminum Fuel Caps

- Attractive and durable aluminum castings.
- Safety venting features:
  - high capacity pressure relief (5-10 psig)
  - high capacity thermal relief (225°-235°F)
- Special compound gasket for tight seal.
- 12" chain and cross-bar combination prevent loss of cap while refueling.



### 2" Dia. Aluminum Fuel Caps (Female Thread)

Sloan No.	Measurement Across Threads	Cross-Bar Length	Thread Type	Lock	Venting
431084	2.25"	3.25"	11.5 NPSM	no	vented

### 2-1/2" Dia. Aluminum Fuel Caps (Female Thread)

Sloan No.	Measurement Across Threads	Cross-Bar Length	Thread Type	Lock	Venting
431085	2.37"	3.25"	8 UN	no	vented

### 3" Dia. Aluminum Fuel Caps (Female Thread)



Sloan No.	Measurement Across Threads	Cross-Bar Length	Thread Type	Lock	Venting
431086	3.37"	7.5"	8 NPSL	no	vented
431087*	3.37"	7.5"	8 NPSL	yes	vented
431088	3.43"	7.5"	**5-1/2 Special	no	vented
431089*	3.43"	7.5"	**5-1/2 Special	yes	vented

\*Indicate suffix -01, -02, or -03 to indicate keying preference.

Same suffix indicates same keying.

\*\* 5-1/2 Special indicates 5-1/2 thread count /inch.

### 4" Dia. Aluminum Fuel Caps (Female Thread)



Sloan No.	Measurement Across Threads	Cross-Bar Length	Thread Type	Lock	Venting
431090	4.37"	7.5"	8 NPSM	no	vented
431091*	4.37"	7.5"	8 NPSM	yes	vented

\*Indicate suffix -01, -02, or -03 to indicate keying preference.

Same suffix indicates same keying.

### 2" Dia. Aluminum Fuel Cap (Female Thread)

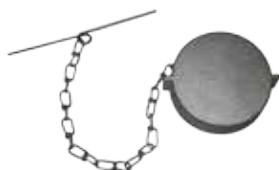

Sloan No.	Measurement Across Threads	Cross-Bar Length	Thread Type	Lock	Venting
431154	2.3"	4-1/2"	11-1/2 NPSM	No	Non-Vented

• Attractive and durable aluminum castings.

• 10" chain and cross-bar combination prevent loss of cap while refueling

# Fuel Caps

## Brass Fuel Caps

- All brass castings for years of corrosion-free performance.
- Fusible elements, in case of fire, melt at 190°F.
- Quality locking feature maintains secure fastening of fuel tank cap to tank.
- All locking caps provided with two keys.
- Available vented or non-vented.
- 8.5" chain and cross-bar combination prevent loss of cap while refueling.
- Most vehicles built before October 1985 have non-vented fuel tanks. Because of the possibility of vapor lock, non-vented fuel caps should not be installed on them.

## Brass Fuel Cap Gaskets (1/8" Dia.)

Sloan No.	Usage
431702	431000, 431002
431715	431008, 431009, 431012
431717	431010, 431011, 431015
431718	431013, 431014
431731	431005, 431006

## 2" Dia. Brass Fuel Caps (Female Thread)



Chain and Toggle

Sloan No.	Measurement Across Threads	Cross-Bar Length	Thread Type	Lock	Venting
431008*	2.3"	3-1/2"	11-1/2 NPSM	no	vented
431009*	2.3"	3-1/2"	11-1/2 NPSM	no	non-vented
431012*	2.3"	3-1/2"	11-1/2 NPSM	yes	vented
431124**	2.3"	14" (External)	11-1/2 NPSM	no	non-vented

\* With chain and toggle

\*\* With external cable

## 2-1/8" Dia. Brass Fuel Caps (Male Thread)



External Cable

Sloan No.	Measurement Across Threads	Cross-Bar Length	Thread Type	Lock	Venting
431010*	2.125"	3-1/2"	12 UN male	no	vented
431011*	2.125"	3-1/2"	12 UN male	no	non-vented

\* With chain and toggle

## 2-1/8" Dia. Brass Fuel Caps (Male Thread)



Sloan No.	Measurement Across Threads	Cross-Bar Length	Thread Type	Lock	Venting
431015	2.125"	3-1/2"	12 UN male	yes	vented

## 2-1/2" Dia. Brass Fuel Caps (Female Thread)

Sloan No.	Measurement Across Threads	Cross-Bar Length	Thread Type	Lock	Venting
431013	2.5"	3-1/2"	8 UN	yes	non-vented
431014	2.5"	3-1/2"	8 UN	no	non-vented

## 4" Dia. Brass Fuel Caps (Female Thread)



Sloan No.	Measurement Across Threads	Cross-Bar Length	Thread Type	Lock	Venting
431005	4.3"	8"	8 NPSM	no	non-vented
431006	4.3"	8"	8 NPSM	yes	non-vented

## 4-1/4" Dia. Brass Fuel Caps (Male Thread)

Sloan No.	Measurement Across Threads	Cross-Bar Length	Thread Type	Lock	Venting
431002	3.7"	8"	8 UN	no	non-vented
431003	3.7"	8"	8 UN	yes	non-vented

- Tramec
- Rubber Hose Assemblies
- Coiled Air Assemblies
- 3-in-1 & 4-in-1 Wraps
- Bulk Hose
- Air Compressor Discharge Hose Assemblies
- Quick Fix™
- Air Hose Accessories
- Hose Clamps
- Gladhands & Accessories
- Air Tanks
- Drain Valves
- Ground Plugs
- Truck Valves
- Selector Valves
- Brass Fittings
- Hose & Tube Chart
- Dash Control Valves
- Air Brake Valves
- Air Accessory Valves
- Air Cylinders
- Switches & Toggles
- Plugs, Sockets & Cables
- RV Plugs & Sockets
- Wire & Cable
- Electrical Harnesses
- Electrical Connectors
- Fuel Caps
- Oil Caps & Dipsticks
- Grease Fittings
- Water Pumps
- Wiper Blades
- Engine Heaters
- Link Cat's Eye®
- Hub Caps, Axilok® & Securex®
- Flitz
- MAXXGreen

## Diesel Fuel Tank Anti-Siphon Devices

- Anti-Siphons are guaranteed for the life of the fuel tank they are installed in.
- Made in the USA.
- Light weight and easy to install.
- Extremely secure.
- Measurements are from the I.D. of the filler neck.
- Does not restrict the flow of fuel into the tank.
- Stops fuel theft at the source.

### Volvo, Mack, International Models

Sloan P/N	I.D.	Length
431151*	1.875"	7.5"
431146	2.5"	6.75"
431145	3.0"	7.0"

\*Fits reefer and medium duty models.



### Kenworth Models

Sloan P/N	I.D.	Length
431148	2.0"	7.5"
431147	2.5"	9.5"



### Freightliner Models

Sloan P/N	I.D.	Length
431150	2.0"	7.5"
431149	2.25"	9.5"



### 4" Fuel Filler Necks

Sloan P/N	I.D.	Length
431152	4.0"	9.0"



#### Note:

Freightliner Class 8 Trucks are 2-1/4" ID.  
 Volvo, Mack, and International are either 2.5" or 3".  
 Sterling's are 2-1/4" or 3".  
 Medium Duty Class 7 International's are usually 1-7/8".  
 Freightliner (M2's) are 2".  
 Reefer Tanks are 1-7/8".  
 Diesel Tanks Only!



# Oil Caps & Dipsticks

## Adjustable Filler Caps

- Creates a positive seal that cannot be bounced or jarred loose.
- Tight seal virtually locks out dirt, rust and other engine damaging matter.
- Available in a variety of standard sizes.
- Special optional features include chain, plastic low clearance handles, and shrouded caps.

Sloan No.	Fits Filler I.D.	Figure	Special Features
431093	1"	A	
431096	1-1/4"	A	
431097	1-1/4"	B	plastic knob
431099	1-3/8"	A	
431100	1-3/8"	C	protective shroud
431094	1-1/2"	A	
431095	1-1/2"	D	with chain
431101	1-5/8"	A	
431098	1-3/4"	A	
431102	1-7/8"	D	with chain
431105	2"	E	low-profile plastic knob
431103	2"	A	
431104	2"	D	with chain
431107	2-1/4"	A	
431108	2-3/8"	D	with chain
431106	2-1/2"	A	
431135	3"	D	with 10" chain
431137	3"	A	
431134	3-7/8"	D	with 10" chain
431136	4-1/4"	A	



Fig. A



Fig. B



Fig. C



Fig. D



Fig. E

### How It Works:

As the handle is turned clockwise, the bottom plate moves upward. This action causes the grooved rubber body to expand, completing a firm, positive, airtight seal. Release with a simple, counter-clockwise turn of the handle.

- Tramec
- Rubber Hose Assemblies
- Coiled Air Assemblies
- 3-in-1 & 4-in-1 Wraps
- Bulk Hose
- Air Compressor Discharge Hose Assemblies
- Quick Fix™
- Air Hose Accessories
- Hose Clamps
- Gladhands & Accessories
- Air Tanks
- Drain Valves
- Ground Plugs
- Truck Valves
- Selector Valves
- Brass Fittings
- Hose & Tube Chart
- Dash Control Valves
- Air Brake Valves
- Air Accessory Valves
- Air Cylinders
- Switches & Toggles
- Plugs, Sockets & Cables
- RV Plugs & Sockets
- Wire & Cable
- Electrical Harnesses
- Electrical Connectors
- Fuel Caps
- Oil Caps & Dipsticks**
- Grease Fittings
- Water Pumps
- Wiper Blades
- Engine Heaters
- Link Cat's Eye®
- Hub Caps, Axilok® & Securex®
- Flitz
- MAXXGreen



## Universal Adjustable Oil Dipsticks

- Fits most makes and models.
- Easy to use...cut to proper length, insert in engine filled with oil, and then mark.



Sloan No.	Size	Blade Size/Material
431116	31/32" x 48"	.032"x.25" Spring Steel
431118	31/32" x 48"	.020"x.187" Spring Steel
431117	31/32" x 84"	.032"x.25" Spring Steel
431119	31/32" x 84"	.020"x.187" Spring Steel
431120	1-1/32" x 48"	.032"x.25" Spring Steel
431121	1-1/32" x 84"	.032"x.25" Spring Steel

## Universal Lock-N-Seal™ Oil Dipstick Tube & Assembly

- Adapts to 3/8", 1/2" or 3/4" O.D. tubes by cutting off, if necessary, a portion of the current tube and attaching the assembly to a steel tube with the fittings provided.
- Provides a leak-proof seal that will not jar loose or pop out of tube.
- Engine Oil Dipstick replacement - Genuine OEM replacement.
- Fits most makes and models.

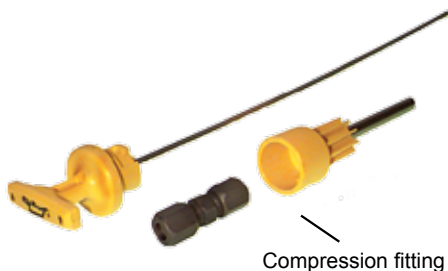

Compression fitting

Sloan No.	Adapting Tube Size	Tube Size	Blade Size
431110	3/8"	.375" x .035" x 4.0"	.250" x .032" x 84.0"
431113	3/8"	.375" x .035" x 4.0"	.187" x .035" x 84.0"
431111	1/2"	.50" x .035" x 4.0"	.250" x .032" x 84.0"
431114	1/2"	.50" x .035" x 4.0"	.187" x .035" x 84.0"
431112	3/4"	.75" x .035" x 4.0"	.250" x .032" x 84.0"
431115	3/4"	.75" x .035" x 4.0"	.187" x .035" x 84.0"

## Cane Handle Dipstick



Sloan No.	Blade Length	Blade Size	Color
431130	60"	.035" x .187"	Yellow
431131	60"	.035" x .187"	Black

- Spring steel blade material
- Pre-phosphate coated

## T-Style Handle Dipstick

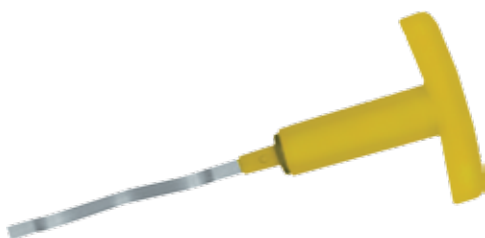

Sloan No.	Blade Length	Blade Size	Color
431132	60"	.035" x .187"	Yellow
431133	60"	.035" x .187"	Black

- Spring steel blade material
- Pre-phosphate coated

# Oil Caps & Dipsticks



OEM NO.	SLOAN NO.	OEM NO.	SLOAN NO.	OEM NO.	SLOAN NO.
<b>Allis Chalmers</b>		<b>Freightliner</b>		<b>Moeller - cont'd</b>	
70694823	431099	44209-2	431099	44098-10	431103
4385253	431094	44165-5	431094	44004-10	431104
4630408	431098	44098-3	431103	44352-10	431105
1190561	431103	44004-4	431104	44052-10	431106
3046080-02	431104	<b>GMC</b>		44402-10	431107
4386863	431107	665370	431096	40855-10	431108
<b>Bucyrus - Erie</b>		513187	431094	<b>Motor Coach - Ind.</b>	
8213191VE	431104	<b>Greyhound</b>		11C-7-17	431093
<b>J.I. Case</b>		11C-7-17	431093	8F-10-6	431104
44141-4	431095	MMC-4090		<b>Oshkosh Truck</b>	
A180978	431096	431107		2004530	431093
902245T1	431099	<b>Hercules</b>		<b>Paccar</b>	
336079R91	431094	WO60501-00	431093	76413	431096
A77424	431103	33778-A	431099	05-5843	431104
303761R91	431103	W175201-000	431103	<b>Peterbilt</b>	
L115504	431104	<b>International</b>		05-15506	431094
<b>Caterpillar</b>		436396C1	431096	05-5843	431103
9Y5810	431093	474617R1	431099	<b>Ray-Go</b>	
37202263	431093	336079R91	431094	208202	431103
9L8439	431096	303761R91	431103	<b>Rexnord</b>	
7J6657	431096	<b>John Deere</b>		297-00218-47	431099
684497	431099	AT-12662-T	431096	<b>Taylor Machine Works</b>	
5L-2952	431094	44165-5	431094	2718-180	431098
7S1803	431095	AT44844	431101	2718-100	431103
4T2581	431101	44052-2	431106	<b>Terex</b>	
6N2985	431102	<b>Kenworth</b>		5120702	431093
9L1756	431103	76413	431096	5117362	431103
37208202	431103	K071-313	431094	<b>U.S. Electrical Motors</b>	
6N2206	431108	05-5843	431103	132591	431105
<b>Clark</b>		<b>Komatsu Dresser</b>		<b>Volvo-GM</b>	
6515779	431093	179179-H1	431099	4682253	431099
<b>Chrysler</b>		303761-R91	431103	02-7068666	431094
595540	431094	<b>Mack Truck</b>		517934	431103
<b>Cummins</b>		222GB135A	431100	Y569405	431104
203877	431096	222GB213	431100	<b>Wabco</b>	
200284	431094	222GB27	431103	VN-5724	431093
101322	431103	222GB27A	431103	VD-4598	431103
107981	431104	222GB177	431104	<b>Warner &amp; Swasey</b>	
3003718	431107	222GB214	431104	8530-1169	431107
<b>Detroit Diesel</b>		<b>Massey Ferguson</b>		<b>Waukesha Motor</b>	
5120702	431093	705-605-M1	431096	176917	431094
5121387	431094	<b>Moeller</b>		4001-420-20	431107
5120098	431098	44141-10	431093	<b>Western Star</b>	
5117362	431103	44165-10	431094	02-7068666	431094
<b>East Greyhound</b>		44901-10	431095	517934	431103
5117362	431103	44050-10	431096	569405	431104
GBK-9106	431104	41085-10	431097		
<b>Ford New Holland</b>		44027-10	431098		
C9NN-6N609A	431096	44209-10	431099		
C7NN-6N609B	431096	44097-10	431100		
D5NN-6N609A	431097	44401-10	431101		
		40733-10	431102		

- Tramec
- Rubber Hose Assemblies
- Coiled Air Assemblies
- 3-in-1 & 4-in-1 Wraps
- Bulk Hose
- Air Compressor Discharge Hose Assemblies
- Quick Fix™
- Air Hose Accessories
- Hose Clamps
- Gladhands & Accessories
- Air Tanks
- Drain Valves
- Ground Plugs
- Truck Valves
- Selector Valves
- Brass Fittings
- Hose & Tube Chart
- Dash Control Valves
- Air Brake Valves
- Air Accessory Valves
- Air Cylinders
- Switches & Toggles
- Plugs, Sockets & Cables
- RV Plugs & Sockets
- Wire & Cable
- Electrical Harnesses
- Electrical Connectors
- Fuel Caps
- Oil Caps & Dipsticks
- Grease Fittings
- Water Pumps
- Wiper Blades
- Engine Heaters
- Link Cat's Eye®
- Hub Caps, Axilok® & Securex®
- Flitz
- MAXXGreen

# Grease Fittings

## SAE



Part Number	Overall Length	Pipe Thread	Hex Size
491807	35/64"	1/4"-28	5/16"
491808	15/16"	1/4"-28	5/16"



Part Number	Overall Length	Pipe Thread	Hex Size	Angle
491809	13/16"	1/4"-28	3/8"	45°
491810	3/4"	1/4"-28	3/8"	90°

## Drive



Part Number	Overall Length	Pipe Thread	Hex Size
491813	17/32"	3/16"	5/16"
491814	35/64"	1/4"	5/16"
491815*	35/64"	5/16"	3/8"

\* Note: No ball check in fitting

## UNF



Part Number	Overall Length	Pipe Thread	Hex Size
491816	9/16"	5/16"-24	3/8"
491817	81/128"	3/8"-24	7/16"

## Pipe Thread



Part Number	Overall Length	Pipe Thread	Hex Size
491801	21/32"	1/8"-27	7/16"
491802	1-1/4"	1/8"-27	7/16"



Part Number	Overall Length	Pipe Thread	Hex Size	Angle
491803	29/32"	1/8"-27	7/16"	30°
491804	55/64"	1/8"-27	7/16"	45°
491805	55/64"	1/8"-27	7/16"	65°
491806	27/32"	1/8"-27	7/16"	90°



Part Number	Overall Length	Pipe Thread	Hex Size	Angle
491811	7/8"	1/4"-18	9/16"	---
491812	31/32"	1/4"-18	9/16"	45°

## Grease Fitting Assortment

### 491800-Grease Fitting Assortment

Part Number	Package Quantity	Description
491801	10	1/8" Male Pipe
491802	10	1/8" 65° Male Pipe
491803	10	1/4"-28 Taper Thread
491805	10	1/8" 30° Male Pipe
491806	10	1/8" 90° Male Pipe
491807	10	1/4"-28 Male Pipe
491809	10	1/8" 45° Male Pipe
491810	10	1/4"-28 Short-.55"
491811	10	1/4"-28 90° Thread
491812	10	1/4" Drive Type Straight

\*491800 is a packaged kit that includes the above fittings.

## Water Pump Trouble Shooting Tips:

Water pump bearing and shaft failures are predominately caused by one or more of the following circumstances:

- **Shaft and Fan are out of square:**

It is extremely important that the fan is mounted square to the center line of the shaft. If it is not square, the fan will wobble, causing vibrations to develop. This is particularly important where shaft spacers are used to move the fan closer to the radiator. The mounting bolts, if not properly torqued, will cause the fan to be tilted and may result in permanent deformation of the spacer.
- **Defective fan unit:**

Relatively minor fan defects can magnify strain on the water pump shaft at 3000 to 5000 RPM. A small piece of missing fan blade can result in tremendous undesirable centrifugal force. Fatigue cracks near the rivets can cause blade shift or vibration. Bent fan blades can cause severe load problems.
- **Fatigued Pulleys:**

Damaging vibration can result from bent or cracked pulleys. This usually occurs when a pulley is improperly handled or installed.
- **Overtightening of Fan Belt:**

An overtightened fan belt can overload the bearing, resulting in shorter than ordinary fatigue life. It also causes bending of the shaft. Sudden acceleration cause large unbalanced loads, excessive shaft bending and early shaft failure.
- **Excessive Acceleration:**

Rapid engine acceleration, particularly in low gear during quick get-aways, place heavy overloads in the bearing. Any minor imbalance can be amplified during rapid acceleration and high speeds, which can result in severe whipping action and sudden fractures.
- **Shaft failure**

Examination of a failed water pump shaft will reveal the possible cause of failure. Discoloration around the fracture indicates high temperatures most likely caused by centrifugal forces due to shaft imbalance. A small amount of imbalance can result in tremendous strain on the shaft at operating RPM's. The overload is focused at one section of the shaft and ultimately the shaft will snap. Lack of discoloration at the break indicates minimal heat build up occurred before a catastrophic vibratory overload of the shaft causes a clean fracture. Rapid acceleration of the engine combined with imbalance in the shaft is the cause. Small vibrations are amplified during rapid acceleration and combined with other engine vibrations can result in a shaft fracture.

Tramec
Rubber Hose Assemblies
Coiled Air Assemblies
3-in-1 & 4-in-1 Wraps
Bulk Hose
Air Compressor Discharge Hose Assemblies
Quick Fix™
Air Hose Accessories
Hose Clamps
Gladhands & Accessories
Air Tanks
Drain Valves
Ground Plugs
Truck Valves
Selector Valves
Brass Fittings
Hose & Tube Chart
Dash Control Valves
Air Brake Valves
Air Accessory Valves
Air Cylinders
Switches & Toggles
Plugs, Sockets & Cables
RV Plugs & Sockets
Wire & Cable
Electrical Harnesses
Electrical Connectors
Fuel Caps
Oil Caps & Dipsticks
Grease Fittings
<b>Water Pumps</b>
Wiper Blades
Engine Heaters
Link Cat's Eye®
Hub Caps, Axilok® & Securex®
Flitz
MAXXGreen

## Important Water Pump Information:

Water pumps are an important part of total engine health. With the new EPA emission regulations they have become more important. Under hood engine temperatures have steadily been increasing for the last decade and will continue to increase with the implementation of more strict emission standards. One of the key engine components that has seen increased failure rates is the water pump. Sloan has focused their resources on an all “New” water pump offering. We have expanded our line to include 30 new pumps while also reducing the price of our current product offering. Sloan offers a 2-year, 200,000 mile warranty on all of our pumps. With the elimination of remanufactured pumps from our line we have also eliminated core charges. We have coverage across all makes and models. A water pump quick reference guide is located on page 194.

We carry pumps for all of the following makes:

**Case**  
**Caterpillar**  
**Cummins**  
**Chevrolet**  
**Detroit Diesel**  
**Ford**  
**GM/GMC**  
**International**  
**Komatsu**  
**Mack**  
**Mercedes**  
**ThermoKing**

### Handling Tips:







- Handle water pump with care
- Always use a new gasket.
- All pumps are greased at the factory; do not add grease.
- Drain and Flush the cooling system.
- Inspect hoses, clamps, thermostat, and radiator cap. Replace if necessary.
- Check fan belt. A glazed belt will slip at high RPM. Over tightening Will cause damage to the water pump (stress on bearing, broken shaft, broken housing)
- The fan clutch should be free running and in proper balance.
- Check the fan for loose rivets, bent blades, cracked blades, wobble and shroud clearance.

# Water Pumps

APPLICATIONS	ILLUSTRATION	O.E.M. PUMP NO.	O.E.M. Casting NO.	SLOAN PART NO.
<b>Case</b>				
<b>Case 188D</b> Includes: Hub and mounting gasket, Impeller Diameter 3 1/8".		A146584 A48363, A36979, A37758, G11939	A37751	6360
<b>Caterpillar</b>				
<b>3208 Engine, 10.4L (636 Cu. In.)</b> Bolt on pulley, Provided without Pulley. Impeller is 4 1/4".		2W1225, 9N6147, OR0781	9N3076, 9L3076, 9N1249	6001
<b>3208 Engine, 10.4L (636 Cu. In.)</b> Bolt on 3-groove pulley (5.62" dia) Provided with Pulley. Impeller is 4 1/4"		2W1225, 9N6147, OR0781	9N3076, 9L3076, 9N1249	6002
<b>3208 Engine, 10.4 L (636 Cu. In.)</b> Threaded bolt on pulley for fan clutch. Impeller is 4 1/4"		2W1227	9N3076, 9L3076	6004
<b>3406B/C Engine, 14.6L (893 Cu. In.)</b> Flat gear, not interchangeable with the 3406 E 5 3/4" impeller. 74 tooth gear, 7-7/8" diameter flat gear.		1354926, 7W7019, 7C4957, OR8217	9N5034	6006
<b>3406B/C</b> Backing Plate Backing Plate. Fits several 3406B models: 1N2959, 2W3277, 9N5035, 1025939, 1341340, 1341341, 3520203, 0R8217, 10R0482.		7C9222 4PL2383	---	6010
<b>3406E Engine,</b> Not interchangeable with the 3406B/C. 5 3/4" impeller. 74 tooth, 7-7/8" diameter dished gear with angled teeth, not interchangeable with 3406B/C.		613890, OR4120, OR8330, OR8218 10R0483	100-7479	6012

- Tramec
- Rubber Hose Assemblies
- Coiled Air Assemblies
- 3-in-1 & 4-in-1 Wraps
- Bulk Hose
- Air Compressor Discharge Hose Assemblies
- Quick Fix™
- Air Hose Accessories
- Hose Clamps
- Gladhands & Accessories
- Air Tanks
- Drain Valves
- Ground Plugs
- Truck Valves
- Selector Valves
- Brass Fittings
- Hose & Tube Chart
- Dash Control Valves
- Air Brake Valves
- Air Accessory Valves
- Air Cylinders
- Switches & Toggles
- Plugs, Sockets & Cables
- RV Plugs & Sockets
- Wire & Cable
- Electrical Harnesses
- Electrical Connectors
- Fuel Caps
- Oil Caps & Dipsticks
- Grease Fittings
- Water Pumps**
- Wiper Blades
- Engine Heaters
- Link Cat's Eye®
- Hub Caps, Axilok® & Securex®
- Flitz
- MAXXGreen

# Water Pumps

APPLICATIONS	ILLUSTRATION	O.E.M. PUMP NO.	O.E.M. Casting NO.	SLOAN PUMP PART NO.
<b>Caterpillar</b>				
<b>3306</b> This pump differs from other 3306 models in that it has a bolt holding the gear in place and lacks a spline drive.		2W8001 OR9785, OR1002	1W4619, 7N196, 172-7827, 154-3945	6013
<b>3116, 3.75" Pulley</b>		4W7589	---	6014
<b>3406B/C/E Engine,</b> Same as the 6012, with a straight tooth on the gear		6I3890, OR4120, OR8330, OR8218	161-5718, 153-9023 (gear#)	6015
<b>C15</b> Bolt-On Dome Gear with Straight Teeth 5.9" Impeller Opening		1615719 10R0484 OR9869	161-5718 161-5719	6019
<b>C12</b>		1767000 1006944 1358053	---	6020
<b>3116 / 3126 with 3.75" Pulley</b>		1208402, 4P3682, OR1011, OR1013, 1593141 4P3682	4P3681 (body), 7W3780 (pulley)	6016
<b>3116 / 3126 with 4.37" Pulley</b>  Comes with installed plugs The only difference between part number 6016 and 6017 is the pulley size		4P3683, 9Y5249, OR1015, OR3007, 9V4879	4P3681 (body), 7C7890 (pulley)	6017

# Water Pumps



APPLICATIONS	ILLUSTRATION	O.E.M. PUMP NO.	O.E.M. Casting NO.	SLOAN PART NO.
<b>Caterpillar</b>				
<b>3116 / 3126 with 3.75" Pulley</b> This pump has one spout. The casting may have an additional port in place of the missing spout and may be factory plugged		1268277	285121	6018
<b>Cummins</b>				
<b>Small Cam FFC, 2-Groove Pulley,</b> 7-hole mount, no vent, 5-1/4" imp. NTC-270-CT, NT855-C280, NTC-290-R, NT855-C310, NT-310, NTC-355, NT855-C335, NTC350, NTA855-C360, NTC290		AR45090, 3801784, 3000886	219040, 210238	6051
<b>Small Cam FCC Idler,</b> 2-groove pulley		3064920, AR8851	208118	6058
<b>Big Cam, multi-groove pulley</b> (4 5/8" dia), 4-1/2" imp., vented, NTC290, NTC350, NTC400, Formula 290, 350 - *non-vented. 7 hole mount		3801788, 3022474, AR45184, 3036876	218274, 3045163	6052
<b>Big Cam III,</b> 4 2/3" multi-groove pulley, 4" impeller Vented, NTC300, 350, 400, Formula 300, 350, 400, 475		3004923	218274	6061
<b>Big Cam IV, 855</b> 4.275 diameter multi-groove pulley, 4-1/2" impeller, 1/4" vented hole. Applications: 300, 350, 400, Fleet 300, NTC-Formula 300, 350, 400, NTC-475		3801708, 3045943 3049543 AR45217	3036877, 3045163	6064
<b>88 Big Cam IV,</b> NTC-300, 315, 350, 365, 400. 4 1/2" impeller, 4.275" multi groove pulley		3803138, 3803030	3062899, 3053538	6069

- Tramec
- Rubber Hose Assemblies
- Coiled Air Assemblies
- 3-in-1 & 4-in-1 Wraps
- Bulk Hose
- Air Compressor Discharge Hose Assemblies
- Quick Fix™
- Air Hose Accessories
- Hose Clamps
- Gladhands & Accessories
- Air Tanks
- Drain Valves
- Ground Plugs
- Truck Valves
- Selector Valves
- Brass Fittings
- Hose & Tube Chart
- Dash Control Valves
- Air Brake Valves
- Air Accessory Valves
- Air Cylinders
- Switches & Toggles
- Plugs, Sockets & Cables
- RV Plugs & Sockets
- Wire & Cable
- Electrical Harnesses
- Electrical Connectors
- Fuel Caps
- Oil Caps & Dipsticks
- Grease Fittings
- Water Pumps**
- Wiper Blades
- Engine Heaters
- Link Cat's Eye®
- Hub Caps, Axilok® & Securex®
- Flitz
- MAXXGreen





APPLICATIONS	ILLUSTRATION	O.E.M. PUMP NO.	O.E.M. Casting NO.	SLOAN PUMP PART NO.
<b>Cummins</b>				
<b>Big Cam Idler,</b> 6 groove pulley.		3064919, AR45189	215397	6059
<b>88 Big Cam IV Idler,</b> Smooth pulley		3065000	---	6070
<b>88 Big Cam IV Idler,</b> 4-groove pulley		3081234, 3062931, 3064201	3064201, 3062693 3064201R	6071
<b>Pancake 5-1/2" bore,</b> short shaft Short shaft with pulley (Non-FFC) NH230, NH250, NHC270, NHE225 Diesel, NT280, NT300, NT310, NT335, NT380, NTA380, NTC280, NTC335, NTC350 Diesel		AR4284, AR4283 BM78372 4919813	196845	6053
<b>N14,</b> N14-310, 330, 350, 370, 410. 4 1/2" impeller 4.275" Multi-Groove Pulley, Modified Suitcase Style, 6 Bolt Mounting.		3803605, 3803361	3069644, 3076523	6073
<b>N14 Idler,</b> Multi-Groove Pulley (6 grooves). Press-on Bearing Cover.		3066330	3072355	6074
<b>LTA 10 Series,</b> Engines before 1991, 4-hole mount, 4.090" impeller, covered gear, Applications: LTA10-240, 270, 300 Engines		3803402, 3801840	3039182, 3035157	6068

# Water Pumps



APPLICATIONS	ILLUSTRATION	O.E.M. PUMP NO.	O.E.M. Casting NO.	SLOAN PART NO.
<b>Cummins</b>				
<b>L10-E Series, 10L (64 Cu. In.)</b> Engines: 1991 & after, 3-hole mount, 4.09 impeller, exposed gear, longer shaft than 3800745RX, L10-310E, L10-330E, M11 series		3803403 4955705 4003929 3800737	3882615	6076
<b>L10, M11</b> Short Shaft, 3-Hole Mount		3800745-rx	3882615	6087
<b>Cummins M11 &amp; L10 E Series 3 Hole (Short Shaft)</b>		4955706 3800745 3800479 4003929 3401009 2882145	---	6090
<b>L-10 Series Idler,</b> Engines before 1991, Fan drive idler assembly, 3.9" multi-groove pulley. 8 grooves, Press-on Bearing Cover.		3062602	3060884, 3064201R, 3062602	6078
<b>B Series New Style</b> 2 hole mount Open Faced, 5 Vane Impeller		3286275	---	6092
<b>B Series,</b> 4 cylinder (3.9L) & 6 cylinder (5.9L). 2 hole mount. Hardened pulley - No belt lip.		3286277, 3802358, 3802004 3913432, R4723690, 3903749, 3802790, F3AZ-8501ARM (Ford Application)	3913132, 3913432 3920310, 3928395, 3903357	6075
<b>ISB Series</b> 5.9L & 6.7L		3800984 4891252	---	6093

- Tramec
- Rubber Hose Assemblies
- Coiled Air Assemblies
- 3-in-1 & 4-in-1 Wraps
- Bulk Hose
- Air Compressor Discharge Hose Assemblies
- Quick Fix™
- Air Hose Accessories
- Hose Clamps
- Gladhands & Accessories
- Air Tanks
- Drain Valves
- Ground Plugs
- Truck Valves
- Selector Valves
- Brass Fittings
- Hose & Tube Chart
- Dash Control Valves
- Air Brake Valves
- Air Accessory Valves
- Air Cylinders
- Switches & Toggles
- Plugs, Sockets & Cables
- RV Plugs & Sockets
- Wire & Cable
- Electrical Harnesses
- Electrical Connectors
- Fuel Caps
- Oil Caps & Dipsticks
- Grease Fittings
- Water Pumps**
- Wiper Blades
- Engine Heaters
- Link Cat's Eye®
- Hub Caps, Axilok® & Securex®
- Flitz
- MAXXGreen

# Water Pumps

APPLICATIONS	ILLUSTRATION	O.E.M. PUMP NO.	O.E.M. Casting NO.	SLOAN PUMP PART NO.
<b>Cummins</b>				
<b>C Series Long Nose</b> Dome Style Nose		3800974 3926912 3923568 3285323		6091
<b>C Series, 8.3L</b> Hardened Pulley with Belt Lip, Short nose. 4 1/3" flat pulley		3804883, 3806180, 3802081, 3905357, 3913430 F3HZ-8501B (Ford Application)	3903357, 3913430, 3802051, 3913439	6077
<b>C Encore</b> Water pump kit - Hard		4089647	---	6084
<b>ISB</b> Hardened Pulley.		3286278, R4723690, 3285410, 3285414	3920310	6081
<b>ISC</b> 8.3L Long Nose/Hardened Pulley.		3286293, 4089647, 3973114,	2370-10C	6082
<b>ISC &amp; ISL</b> ISC (8.3L) & ISL (8.9L) Dome Pulley.		3804927, 3940052, 4089647(NX)	2370-10L, 2369-10, 1926-10	6086
<b>DINA</b> 6-cyl, 8-cyl V-6 (155 Cu. In.) Engines V-8 (210 Cu. In.) Engines		AR61788, A34079A05 4919812	555260	6083

# Water Pumps

APPLICATIONS	ILLUSTRATION	O.E.M. PUMP NO.	O.E.M. Casting NO.	SLOAN PART NO.
<b>Cummins</b>				
<b>Cummins ISX 10GR</b> 15.0L (912 Cu. In.) Equipped with 10-Ribbed serpentine belt pulley		4089908	---	6088
<b>Cummins ISX 12GR</b> 15.0L (912 Cu. In.) Equipped with 12-Ribbed serpentine belt pulley		4089910	---	6089
<b>Detroit Diesel</b>				
<b>53 Series</b> Left Hand, 2-Belt Pulley		23506003, 5144685 5109551	5144688, 5119280	6101
<b>53 Series</b> Right Hand, 2-Belt Pulley		23506007, 5144686 5178658, 5144687, 5109046	5144689, 5178318, 5119281, 5144889	6102
<b>71 Series In-line</b> Left hand, standard capacity		23506723, 5149706 5150439, 5159059, 5186575, 5135595	5135601, 5186573, 8920924, 5178317	6103
<b>71 Series In-line</b> Right hand, standard capacity		23506735, 5149707 5135596, 5186576, 5159060	5135602, 5186574, 8920925 517318	6104
<b>71 Series In-line</b> Left hand, high capacity		23506704, 5149710, 8920915, 23506204	5182069, 8920915 8920917	6113







- Tramec
- Rubber Hose Assemblies
- Coiled Air Assemblies
- 3-in-1 & 4-in-1 Wraps
- Bulk Hose
- Air Compressor Discharge Hose Assemblies
- Quick Fix™
- Air Hose Accessories
- Hose Clamps
- Gladhands & Accessories
- Air Tanks
- Drain Valves
- Ground Plugs
- Truck Valves
- Selector Valves
- Brass Fittings
- Hose & Tube Chart
- Dash Control Valves
- Air Brake Valves
- Air Accessory Valves
- Air Cylinders
- Switches & Toggles
- Plugs, Sockets & Cables
- RV Plugs & Sockets
- Wire & Cable
- Electrical Harnesses
- Electrical Connectors
- Fuel Caps
- Oil Caps & Dipsticks
- Grease Fittings
- Water Pumps**
- Wiper Blades
- Engine Heaters
- Link Cat's Eye®
- Hub Caps, Axilok® & Securex®
- Flitz
- MAXXGreen

APPLICATIONS	ILLUSTRATION	O.E.M. PUMP NO.	O.E.M. Casting NO.	SLOAN PUMP PART NO.
<b>Detroit Diesel</b>				
<b>71 Series In-line</b> Right hand, high capacity		23506711, 5149708, 8920916,	5135611, 5182070, 8920916 8920918,	6114
<b>8.2L Diesel</b> "Late" Style With Heater Bypass. No Pulley.		8928672 8927158	8924657 8828804, 8926904, 40-181 (Aftermarket Casting # 40-181)	6119
<b>50 Series &amp; 60 Series</b> After 12/90. 61 tooth gear. Rear Mount, Premium Seal, Metal Back Plate/Seal, Gear Driven, Std. Flow Capacity, 7 Vane Impeller.		23505895, 23505895, 23520136, R3518216, 23522707	23505894, 23517027	6122
<b>50 Series &amp; 60 Series "pocket Style"</b> After 12/90. High Capacity w/ reservoir/pouch. Second Series. Gear Driven w/ 2 Outlets, High Horsepower (470 & up), 3/8" Pipe Ports & High Capacity 6 Vane Impeller.		23522721, 23526039 23517025, 23518215, 23522707	23517027, 23522721	6131
<b>Series 60 EGR</b> 12.7L Water Pump  EGR=Exhaust Gas Recirculation		23532542, 23535017, 23531257	23530427	6132
<b>Series 60 EGR</b> 14.0L Water Pump  EGR=Exhaust Gas Recirculation		23532543 23535018 23531258	23530429	6133
<b>Ford</b>				
<b>6.0 Turbo Diesel Powerstroke 2003-2005</b>		3C3Z8501 PW480 3C3Z-8501-BA 3C3Z-8501-ABRM	---	6125







# Water Pumps

APPLICATIONS	ILLUSTRATION	O.E.M. PUMP NO.	O.E.M. Casting NO.	SLOAN PART NO.
<b>Ford</b>				
<b>6.0 Turbo Diesel Powerstroke 2005-Current</b>		4C3Z8501AC PW491 4C3Z-8501-AB 4C3Z-8501-ABRM F81Z8501-ABRM	---	6126
<b>Ford 6.0L Diesel Powerstroke 2004 - 2006</b>		18-1784, 4C3Z- 8501ABRM, F81Z8501ABRM	---	6128
<b>Ford 6.0L Diesel Powerstroke 2003</b>		18-1785, 3C3Z-8501ABRM	---	6129
<b>Ford 6.0L Diesel Powerstroke Heavy Duty 2003-2006</b>		18-1786	---	6130
<b>6.9/7.3 Liter Diesel, 1983-94 (non Power Stroke) Belt Driven, 4-1/2" Hub Outside Diameter, Pulley Not Supplied, Threaded Hub.</b>		E4TZ-8501C, E4TZ-8501B	446430C1, 446430C2, 446430C3, 446430C4	6304
<b>6.9/7.3 Liter Diesel, 1983-94 (non power stroke) 1991-93, 1994 F600 only with out Pump Mounted Fan.</b>		F1HZ-8501CRM	F0HN8505AA, F0HZ-8508-AA	6309
<b>7.3 Liter Turbo Diesel, 1994-95, Direct Injection.</b>		F4TZ-8501ARM, F5TZ-8501BRM F5TZ-8501B, F5TZ-8501C	1822823C1 1823611C2	6310

- Tramec
- Rubber Hose Assemblies
- Coiled Air Assemblies
- 3-in-1 & 4-in-1 Wraps
- Bulk Hose
- Air Compressor Discharge Hose Assemblies
- Quick Fix™
- Air Hose Accessories
- Hose Clamps
- Gladhands & Accessories
- Air Tanks
- Drain Valves
- Ground Plugs
- Truck Valves
- Selector Valves
- Brass Fittings
- Hose & Tube Chart
- Dash Control Valves
- Air Brake Valves
- Air Accessory Valves
- Air Cylinders
- Switches & Toggles
- Plugs, Sockets & Cables
- RV Plugs & Sockets
- Wire & Cable
- Electrical Harnesses
- Electrical Connectors
- Fuel Caps
- Oil Caps & Dipsticks
- Grease Fittings
- Water Pumps**
- Wiper Blades
- Engine Heaters
- Link Cat's Eye®
- Hub Caps, Axilok® & Securex®
- Flitz
- MAXXGreen



APPLICATIONS	ILLUSTRATION	O.E.M. PUMP NO.	O.E.M. Casting NO.	SLOAN PUMP PART NO.
<b>Ford</b>				
<b>7.3 Liter Turbo Diesel,</b> 1996-01 Direct Injection. Application: 2000-2002 E150/E350, 2000-2002 Excursion, 1996-2002 F250, F350, F450, F550 Super Duty, 1996-1997 F53/59 Stripped Chassis		F6TZ-8501AA, F7TZ-8501BRM, F81Z-8501ARM, F81Z-8501A, F81Z-8501B, F81Z-8501CRM, F81Z-8501FA, F7TZ-8501B, F7TZ-8501C F6TZ-8505ARM, F6TZ-8505BRM,	1831005C2	6311
<b>6.6/7.8 Liter,</b> 401 & 476 Diesel 1987-1991. Auxillary Mount, 3/4" Outlet, Cab Over.		E8HZ8501B E7HZ8501A, E9TZ8501B	E7HN8508AA, E6HN8508AA, E7HN8508AA	6314
<b>GM/GMC</b>				
<b>6.2/6.5 Liter Diesel,</b> 1982-96 1986-90 Chevy & GMC, Belt Driven, Conventional Cab, Pulley Not Supplied.		12514269, 15633465, 15633466 12633466 14082745, 23500133, 14061698	14024206	6117
<b>6.6 Liter Duramax</b> 2001-2004		97216136 19113733, 252723, 251674, 252383	---	6123
<b>6.5 Liter Diesel</b> 1996-1999		12530176 19168610, 88894036, 251-590 5744662 12534772	12553486 12557071	6124
<b>Chevrolet Duramax 6.6L Diesel</b> 2001 - 2006		97372515 98031233	---	6127
<b>International</b>				
<b>DT466 Engine,</b> Conventional Cab Models Belt Driven, Pulley Not Supplied		685155C94, 685155C92	677856C1, 677856C2	6301

# Water Pumps

APPLICATIONS	ILLUSTRATION	O.E.M. PUMP NO.	O.E.M. Casting NO.	SLOAN PART NO.
<b>International</b>				
<b>DT466 Engine,</b> Cab Over Engine Models Belt Driven, Pulley Not Supplied		680899C92	677137C1	6302
<b>6.9/7.3 Liter Diesel,</b> MV-404 and 446 Gas Engine Belt Driven, 2-5/8" Hub O.D., Pulley Not supplied.		1809374C91 E4T2-8501C, 1805951C91, 1805952C91	446430C1, 446430C2, 446430C3	6305
<b>9.0 Liter Engine,</b> 1976-83 Cargostar, S Series with 9.0L Diesel Engine, Press On Hub, Belt Driven.		1700594C91, 1700594C92	489173C1	6306
<b>DTA360 Engine, 5.9L (360 Cu. In.)</b> left hand thread w/bolt on 1" thick hub, Belt Driven, Pulley Not Supplied.		1815538C91 ZGA735327, 735445C91	677856C3	6307
<b>7.6L 466, 8.6L 530, 6.7L 408</b> 1994-97. Application: Various with 6 Cylinder DT360/466 New Generation Diesel Engines. Stamped Steel Impeller.		1817687C92 1817687C94 1817687C95 1817687C96	1821935C91, 1821935C1, 1821935C3	6313
<b>International Truck &amp; Bus DT444E &amp; T444E 7.3L</b> 1994-2004 Right Hand, Direct Injection, Screw on Filter.		1831676C92, 1823669C92, 1831676C31 YC3Z-8501AARM YC3Z8501CA 183167691	1822851C1 1823669C92	6315
<b>International 7.3L T444E</b>		---	---	6316

- Tramec
- Rubber Hose Assemblies
- Coiled Air Assemblies
- 3-in-1 & 4-in-1 Wraps
- Bulk Hose
- Air Compressor Discharge Hose Assemblies
- Quick Fix™
- Air Hose Accessories
- Hose Clamps
- Gladhands & Accessories
- Air Tanks
- Drain Valves
- Ground Plugs
- Truck Valves
- Selector Valves
- Brass Fittings
- Hose & Tube Chart
- Dash Control Valves
- Air Brake Valves
- Air Accessory Valves
- Air Cylinders
- Switches & Toggles
- Plugs, Sockets & Cables
- RV Plugs & Sockets
- Wire & Cable
- Electrical Harnesses
- Electrical Connectors
- Fuel Caps
- Oil Caps & Dipsticks
- Grease Fittings
- Water Pumps**
- Wiper Blades
- Engine Heaters
- Link Cat's Eye®
- Hub Caps, Axilok® & Securex®
- Flitz
- MAXXGreen





APPLICATIONS	ILLUSTRATION	O.E.M. PUMP NO.	O.E.M. Casting NO.	SLOAN PUMP PART NO.
<b>International</b>				
<b>International 7.6L DT466 &amp; 530E New Generation</b> 2003 - 2007 5-Bolt Pump, Bolt on Pulley.		1842664C92 1842665C93	1841765C1	6317
<b>Komatsu</b>				
<b>S/SA 6D105 Water Pump</b>	Photo unavailable at time of print.	6090-01-1701	---	6353
<b>S/SA 6D125 Water Pump</b>	Photo unavailable at time of print.	6151-61-1101	---	6354
<b>Volvo/Mack</b>				
<b>Long Shaft Maxidyne</b> 1.57" Long Shaft. Mack Endt 675, 676 Engines. No Pulley, Iron Impeller.		316GB443, 316GC1184, 316GC1211A, 316GC1211B	360GB443 360GB343	6205
<b>Charged Air Econodyne,</b> no pulley, .94" Long Shaft. Mack E6, EM6 & EMS-6 Engines		316GC1210A	360GB443	6208
<b>Charged Air Econodyne,</b> 3-Groove Pulley, 6-5/8" Diameter Pulley, Pulley Included. Mack E6, EM6 & EMS-6 Engine		316GC1210AX 316GC1210A	360GB443	6217
<b>ASET Water Pump with 5.3" Pulley</b>		315GC3193	2739-17	6219

# Water Pumps

APPLICATIONS	ILLUSTRATION	O.E.M. PUMP NO.	O.E.M. Casting NO.	SLOAN PART NO.
<b>Volvo/Mack</b>				
<b>ASET Water Pump with 5.9" Pulley</b>		315GC3196	2738-17	6220
<b>Mercedes Benz Truck</b>				
<b>OM366, OM366A, OM366LA</b>		366-200-5901 366-200-0901, 366-200-0401, 366-200-4601, 355-200-5901	---	6355
<b>OM366LA Euro II</b>		366-200-6001 366-200-1501	---	6356
<b>OM364, OM364A</b> 112 x 15mm Impeller.		364-200-2001, 364-200-0101, 364-200-0901	---	6357
<b>OM904</b> 112 x15mm Impeller.		904-200-0401 904-200-0801, 904-200-2601, 904-200-5101, 904-200-2001, 904-200-4901, 904-200-2661, 904-200-0601	---	6358
<b>Sprinter Van, L5, 2.7L</b> For 2500, 3500 2.7L Diesel. 2004-2007.		A6472000101 A642-200-1301 5138057AA 647-2000-0101	---	6359
<b>ThermoKing</b>				
<b>Refrigeration Units, ISUZU C201</b> Diesel Engine. 207CC Engine.		11-4576 977696	BTK, PH374	6350

- Tramec
- Rubber Hose Assemblies
- Coiled Air Assemblies
- 3-in-1 & 4-in-1 Wraps
- Bulk Hose
- Air Compressor Discharge Hose Assemblies
- Quick Fix™
- Air Hose Accessories
- Hose Clamps
- Gladhands & Accessories
- Air Tanks
- Drain Valves
- Ground Plugs
- Truck Valves
- Selector Valves
- Brass Fittings
- Hose & Tube Chart
- Dash Control Valves
- Air Brake Valves
- Air Accessory Valves
- Air Cylinders
- Switches & Toggles
- Plugs, Sockets & Cables
- RV Plugs & Sockets
- Wire & Cable
- Electrical Harnesses
- Electrical Connectors
- Fuel Caps
- Oil Caps & Dipsticks
- Grease Fittings
- Water Pumps**
- Wiper Blades
- Engine Heaters
- Link Cat's Eye®
- Hub Caps, Axilok® & Securex®
- Flitz
- MAXXGreen

# Water Pumps

APPLICATIONS	ILLUSTRATION	O.E.M. PUMP NO.	O.E.M. Casting NO.	SLOAN PUMP PART NO.
<b>ThermoKing</b>				
<b>Refrigeration Units, ISUZU</b> 2.2 Liter Direct Inj. Threaded Auxiliary Port.		11-5858	M1, M2, M3	6352
<b>2.2L ISUZU</b> Refrigeration Units		11-5252 11-9356	---	6361
<b>Yanmar 482/486</b> Refrigeration Units		18-1910	---	6362

# Wiper Blades



We are proud to handle all your wiper blade needs. We are the exclusive source for Michelin Heavy Duty wiper blades in the industry.

We carry the following types of wiper blades :

- Michelin Stealth Blades
- Michelin RainForce Blades
- Michelin Winter Blades
- Michelin Bulk Blades
- Sloan Flat Blades
- Sloan Flex Blades



<b>Tramec</b>
<b>Rubber Hose Assemblies</b>
<b>Coiled Air Assemblies</b>
<b>3-in-1 &amp; 4-in-1 Wraps</b>
<b>Bulk Hose</b>
<b>Air Compressor Discharge Hose Assemblies</b>
<b>Quick Fix™</b>
<b>Air Hose Accessories</b>
<b>Hose Clamps</b>
<b>Gladhands &amp; Accessories</b>
<b>Air Tanks</b>
<b>Drain Valves</b>
<b>Ground Plugs</b>
<b>Truck Valves</b>
<b>Selector Valves</b>
<b>Brass Fittings</b>
<b>Hose &amp; Tube Chart</b>
<b>Dash Control Valves</b>
<b>Air Brake Valves</b>
<b>Air Accessory Valves</b>
<b>Air Cylinders</b>
<b>Switches &amp; Toggles</b>
<b>Plugs, Sockets &amp; Cables</b>
<b>RV Plugs &amp; Sockets</b>
<b>Wire &amp; Cable</b>
<b>Electrical Harnesses</b>
<b>Electrical Connectors</b>
<b>Fuel Caps</b>
<b>Oil Caps &amp; Dipsticks</b>
<b>Grease Fittings</b>
<b>Water Pumps</b>
<b>Wiper Blades</b>
<b>Engine Heaters</b>
<b>Link Cat's Eye®</b>
<b>Hub Caps, Axilok® &amp; Securex®</b>
<b>Flitz</b>
<b>MAXXGreen</b>

## Michelin Stealth Hybrid Blades



Sloan No.	Length	Description	Packaging
6716	16"	Hybrid Wiper Blade	Blister Pack
6717	17"	Hybrid Wiper Blade	Blister Pack
6718	18"	Hybrid Wiper Blade	Blister Pack
6719	19"	Hybrid Wiper Blade	Blister Pack
6720	20"	Hybrid Wiper Blade	Blister Pack
6721	21"	Hybrid Wiper Blade	Blister Pack
6722	22"	Hybrid Wiper Blade	Blister Pack
6724	24"	Hybrid Wiper Blade	Blister Pack
6726	26"	Hybrid Wiper Blade	Blister Pack
6728	28"	Hybrid Wiper Blade	Blister Pack

\*Standard pack of 5

Smart-Flex Design Fits Windshields Better  
Superior windshield contact

All Seasons Rated  
Excellent performance in rain, ice and snow

Built Tough  
For durable wiping performance

Wiper Blades

### Beam Blade



- Aerodynamic Design
- Anti-Snow Build-Up

### Traditional Blade



- Excellent Windshield Contact
- Spring Loaded

### Michelin Stealth Hybrid Blade



- Superior Windshield Contact
- Superior Winter Performance
- Superior Patent Pending Spring Loaded Design



# Wiper Blades

## Michelin RainForce Wiper Blades



Sloan No.	Length	Description	Packaging
6811	11"	Standard Wiper Blade	Blister Pack
6812	12"	Standard Wiper Blade	Blister Pack
6813	13"	Standard Wiper Blade	Blister Pack
6814	14"	Standard Wiper Blade	Blister Pack
6815	15"	Standard Wiper Blade	Blister Pack
6816	16"	Standard Wiper Blade	Blister Pack
6817	17"	Standard Wiper Blade	Blister Pack
6818	18"	Standard Wiper Blade	Blister Pack
6819	19"	Standard Wiper Blade	Blister Pack
6820	20"	Standard Wiper Blade	Blister Pack
6821	21"	Standard Wiper Blade	Blister Pack
6822	22"	Standard Wiper Blade	Blister Pack
6824	24"	Standard Wiper Blade	Blister Pack
6826	26"	Standard Wiper Blade	Blister Pack
6828	28"	Standard Wiper Blade	Blister Pack

\*Standard pack of 5

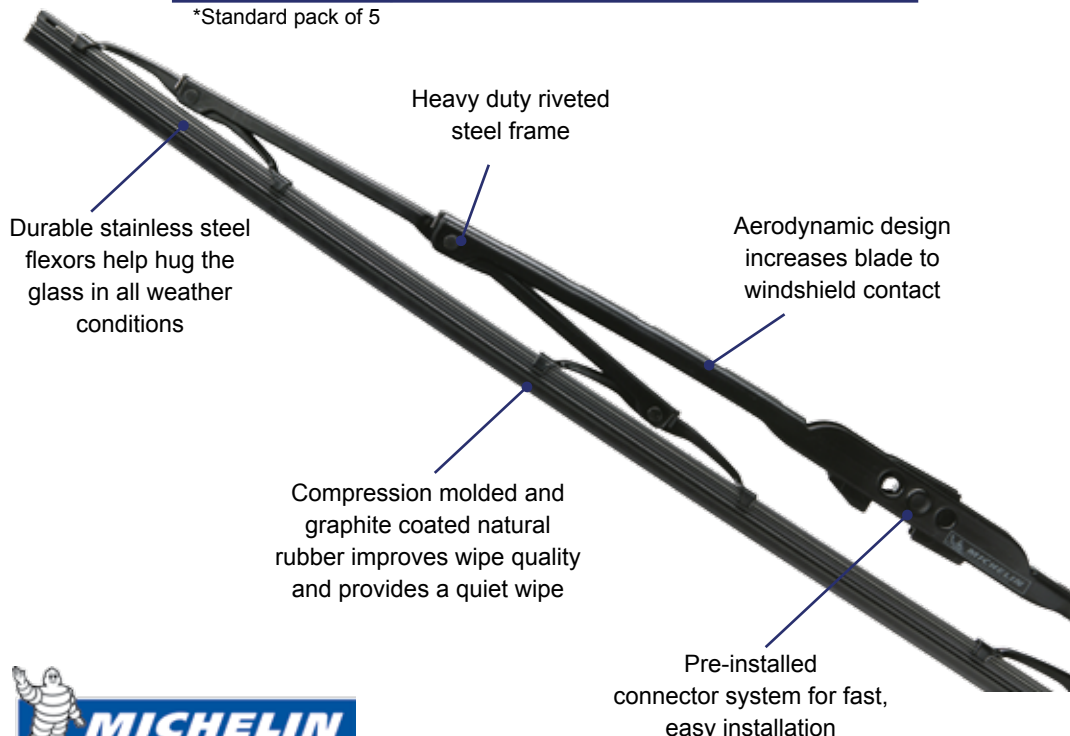

- Tramec
- Rubber Hose Assemblies
- Coiled Air Assemblies
- 3-in-1 & 4-in-1 Wraps
- Bulk Hose
- Air Compressor Discharge Hose Assemblies
- Quick Fix™
- Air Hose Accessories
- Hose Clamps
- Gladhands & Accessories
- Air Tanks
- Drain Valves
- Ground Plugs
- Truck Valves
- Selector Valves
- Brass Fittings
- Hose & Tube Chart
- Dash Control Valves
- Air Brake Valves
- Air Accessory Valves
- Air Cylinders
- Switches & Toggles
- Plugs, Sockets & Cables
- RV Plugs & Sockets
- Wire & Cable
- Electrical Harnesses
- Electrical Connectors
- Fuel Caps
- Oil Caps & Dipsticks
- Grease Fittings
- Water Pumps
- Wiper Blades**
- Engine Heaters
- Link Cat's Eye®
- Hub Caps, Axilok® & Securex®
- Flitz
- MAXXGreen

## Michelin Bulk Wiper Blades

Sloan No.	Length	Description	Packaging
6811B	11"	Standard Wiper Blade	Bulk Pack
6812B	12"	Standard Wiper Blade	Bulk Pack
6813B	13"	Standard Wiper Blade	Bulk Pack
6814B	14"	Standard Wiper Blade	Bulk Pack
6815B	15"	Standard Wiper Blade	Bulk Pack
6816B	16"	Standard Wiper Blade	Bulk Pack
6817B	17"	Standard Wiper Blade	Bulk Pack
6818B	18"	Standard Wiper Blade	Bulk Pack
6819B	19"	Standard Wiper Blade	Bulk Pack
6820B	20"	Standard Wiper Blade	Bulk Pack
6821B	21"	Standard Wiper Blade	Bulk Pack
6822B	22"	Standard Wiper Blade	Bulk Pack
6824B	24"	Standard Wiper Blade	Bulk Pack
6826B	26"	Standard Wiper Blade	Bulk Pack
6828B	28"	Standard Wiper Blade	Bulk Pack

\*Standard pack of 10

- Easy open cellophane packaging for quick changeouts.
- No blister packs to have to open and dispose of.
- Small shelf profile for added storage.
- 1 Box contains product to replace the blades on 5 tractors.



## Michelin Winter Blades



Sloan No.	Length	Description	Packaging
2616	16"	Winter Wiper Blade	Blister Pack
2618	18"	Winter Wiper Blade	Blister Pack
2620	20"	Winter Wiper Blade	Blister Pack
2622	22"	Winter Wiper Blade	Blister Pack
2624	24"	Winter Wiper Blade	Blister Pack

\*Standard pack of 5

- Durable rubber boot that resists exposure to salt, snow, sleet, and ice.
- Inner frame parts are made of heavy-duty 304 stainless steel.
- Features a compression molded natural rubber wiping element.



# Wiper Blades

## Sloan Flat Wiper Blades



Sloan No.	Length	Description	Packaging
6811F	11"	Flat Wiper Blade	Bulk Pack
6812F	12"	Flat Wiper Blade	Bulk Pack
6813F	13"	Flat Wiper Blade	Bulk Pack
6814F	14"	Flat Wiper Blade	Bulk Pack
6815F	15"	Flat Wiper Blade	Bulk Pack
6816F	16"	Flat Wiper Blade	Bulk Pack
6817F	17"	Flat Wiper Blade	Bulk Pack
6818F	18"	Flat Wiper Blade	Bulk Pack
6819F	19"	Flat Wiper Blade	Bulk Pack
6820F	20"	Flat Wiper Blade	Bulk Pack
6821F	21"	Flat Wiper Blade	Bulk Pack
6822F	22"	Flat Wiper Blade	Bulk Pack

\*Standard pack of 10

- These blades are designed for flat windshields, which are typically found on heavy duty trucks, school buses, step vans and recreational vehicles.

## Sloan Flex Wiper Blades



Sloan No.	Length	Description	Packaging
6812FX	12"	Flex Wiper Blade	Bulk Pack
6814FX	14"	Flex Wiper Blade	Bulk Pack
6815FX	15"	Flex Wiper Blade	Bulk Pack
6816FX	16"	Flex Wiper Blade	Bulk Pack
6818FX	18"	Flex Wiper Blade	Bulk Pack
6820FX	20"	Flex Wiper Blade	Bulk Pack
6822FX	22"	Flex Wiper Blade	Bulk Pack
6824FX	24"	Flex Wiper Blade	Bulk Pack
6826FX	26"	Flex Wiper Blade	Bulk Pack
6828FX	28"	Flex Wiper Blade	Bulk Pack
6832FX	32"	Flex Wiper Blade	Bulk Pack

\*Standard pack of 10

- Flex blades are designed for wiper arms that have less than 48 oz. of load.
- The flex blades may be used with flat and curved windshields.

- Tramec
- Rubber Hose Assemblies
- Coiled Air Assemblies
- 3-in-1 & 4-in-1 Wraps
- Bulk Hose
- Air Compressor Discharge Hose Assemblies
- Quick Fix™
- Air Hose Accessories
- Hose Clamps
- Gladhands & Accessories
- Air Tanks
- Drain Valves
- Ground Plugs
- Truck Valves
- Selector Valves
- Brass Fittings
- Hose & Tube Chart
- Dash Control Valves
- Air Brake Valves
- Air Accessory Valves
- Air Cylinders
- Switches & Toggles
- Plugs, Sockets & Cables
- RV Plugs & Sockets
- Wire & Cable
- Electrical Harnesses
- Electrical Connectors
- Fuel Caps
- Oil Caps & Dipsticks
- Grease Fittings
- Water Pumps
- Wiper Blades**
- Engine Heaters
- Link Cat's Eye®
- Hub Caps, Axilok® & Securex®
- Flitz
- MAXXGreen



## Michelin POS Displays

### 9940 Wiper Blade 40-Blade Assortment

Assortment Includes:

Sloan No.	Length	Description	Packaging
6816	16"	Rainforce Wiper Blade	Blister Pack
6818	18"	Rainforce Wiper Blade	Blister Pack
6820	20"	Rainforce Wiper Blade	Blister Pack
6822	22"	Rainforce Wiper Blade	Blister Pack



### 9941 Moveable Wiper Blade Display

- Display does not include stock



### 9942 Pegboard Wiper Blade Display

- Display does not include stock
- Pegboard not included



# Wiper Blades



## Sloan Wiper Blade Interchange

Sloan No.	Anco No.	Sloan No.	Anco No.
2616	30-16	6819F	54-19
2618	30-18	6820F	54-20
2620	30-20	6813F	57-23
2622	30-22	6814F	57-24
2624	30-24	6815F	57-25
6812	31-12	6816F	57-26
6813	31-13	6818F	57-28
6814	31-14	6812	91-12
6815	31-15	6813	91-13
6816	31-16	6814	91-14
6817	31-17	6815	91-15
6818	31-18	6816	91-16
6819	31-19	6817	91-17
6820	31-20	6818	91-18
6821	31-21	6819	91-19
6822	31-22	6820	91-20
6824	31-24	6821	91-21
6826	31-26	6822	91-22
6828	31-28	6824	91-24
6811F	51-11	6826	91-26
6812F	51-12	6828	91-28
6813F	51-13	6816	99-16
6814F	51-14	6817	99-17
6815F	51-15	6818	99-18
6816F	51-16	6819	99-19
6817F	51-17	6820	99-20
6818F	51-18	6821	99-21
6819F	51-19	6822	99-22
6820F	51-20	6824	99-24
6821F	51-21	6828	99-28
6822F	51-22		
6824F	51-24		
6826F	51-26		
6828F	51-28		
6811FX	52-11		
6812FX	52-12		
6813FX	52-13		
6814FX	52-14		
6815FX	52-15		
6816FX	52-16		
6817FX	52-17		
6818FX	52-18		
6819FX	52-19		
6820FX	52-20		
6821FX	52-21		
6822FX	52-22		
6824FX	52-24		
6826FX	52-26		
6828FX	52-28		
6811F	54-11		
6813F	54-13		
6814F	54-14		
6815F	54-15		
6816F	54-16		
6818F	54-18		

Sloan No.	Trico No.	Sloan No.	Trico No.
6811	11-1	2622	27-229
6812	12-2	6828	28-9
6813	13-1	2616	37-160
6814	14-1	2616	37-169
6716	14-160	2618	37-180
6717	14-170	2618	37-189
6718	14-180	2620	37-205
6719	14-190	2620	37-209
6714	14-2	2622	37-225
6721	14-210	2624	37-245
6720	14-220	6811F	61-110
6722	14-220	6812F	61-120
6724	14-240	6813F	61-130
6726	14-260	6814F	61-140
6728	14-280	6815F	61-150
6814	14-8	6816F	61-160
6815	15-1	6817F	61-170
6816	16-1	6818F	61-180
6716	16-160	6819F	61-190
6717	16-170	6820F	61-200
6718	16-180	6821F	61-210
6719	16-190	6822F	61-220
6716	16-2	6824F	61-240
6720	16-200	6826F	61-260
6721	16-210	6828F	61-280
6722	16-220	6811FX	63-110
6724	16-240	6812FX	63-120
6726	16-260	6813FX	63-130
6728	16-280	6814FX	63-140
6816	16-8	6815FX	63-150
6817	17-1	6816FX	63-160
6817	17-3	6817FX	63-170
6818	18-1	6818FX	63-180
6818	18-2	6819FX	63-190
6818	18-8	6820FX	63-200
6819	19-1	6821FX	63-210
6819	19-2	6822FX	63-220
6819	19-3	6824FX	63-240
6819	19-7	6826FX	63-260
6819	19-9	6828FX	63-280
6820	20-1		
6820	20-2		
6820	20-3		
6820	20-4		
6820	20-8		
6820	20-9		
6821	21-1		
6821	21-9		
6822	22-1		
6822	22-4		
6822	22-9		
6824	24-1		
6824	24-4		
6824	24-9		
6826	26-1		

- Tramec
- Rubber Hose Assemblies
- Coiled Air Assemblies
- 3-in-1 & 4-in-1 Wraps
- Bulk Hose
- Air Compressor Discharge Hose Assemblies
- Quick Fix™
- Air Hose Accessories
- Hose Clamps
- Gladhands & Accessories
- Air Tanks
- Drain Valves
- Ground Plugs
- Truck Valves
- Selector Valves
- Brass Fittings
- Hose & Tube Chart
- Dash Control Valves
- Air Brake Valves
- Air Accessory Valves
- Air Cylinders
- Switches & Toggles
- Plugs, Sockets & Cables
- RV Plugs & Sockets
- Wire & Cable
- Electrical Harnesses
- Electrical Connectors
- Fuel Caps
- Oil Caps & Dipsticks
- Grease Fittings
- Water Pumps
- Wiper Blades**
- Engine Heaters
- Link Cat's Eye®
- Hub Caps, Axilok® & Securex®
- Flitz
- MAXXGreen



## HOTSTART®

### **Engine Heater Information:**



Engine Heaters serve a variety of purposes. They are an important part of the engine and help provide trouble-free start-ups. On the following pages you will find a variety of products that will help sustain trouble-free engine start-ups. Engine heaters help save on warm-up time, reducing time spent idling. This helps save on fuel and prolongs battery life. The heaters reduce engine wear, 90% of engine wear is due to low water jacket temperatures.

### **Battery Heater Information:**

At 0°F your battery has only 40% cranking power. With a battery heater you can increase cranking power to 100%. The battery heaters sustain your battery temperature at 80°F allowing more cranking power. When batteries are placed in an insulated battery box, a thermostat is recommended to sense battery box temperature to prevent overheating the battery. The battery heaters are made of a durable, fire-retardant vinyl cover that resists oils and acids. All standard battery pads and battery wraps come with 6" grounded cord and plug. The pads can boost cranking power as much as 75%.

### **Silicone Hot Pad Information:**

Adhesive hot pad heaters are ideal for oil pans, hydraulic reservoirs, engine blocks, hydraulic cylinders and diesel fuel tanks. Application is made easy with a peel and stick feature. They have an etched foil heating element for optimal heat transfer and extended life. The durable silicone/fiberglass cover resists abrasion. They come fully assembled with a standard 6ft HPN cord and plug.

APPLICATIONS	ILLUSTRATION	DESCRIPTION	SLOAN PART NO.
Detroit Diesel 6V-71 & 8V-71 6V-92 & 8V-92 Except GMC General Models		120 V, 1500 W	2951
Cat 3208		1500 W, 1" Plug	2954

# Engine Heaters



APPLICATIONS	ILLUSTRATION	DESCRIPTION	SLOAN PART NO.
CAT C9,15,16 NON-ACERT, DETROIT DIESEL 60 SERIES PRE-2007		1500 W, 1" NPT HEATER AND 11' CORD	2915 2937
CAT C7 ACERT ENGINE MODEL 3114, 3116, 3126		1500 W, 44 MM FP 1000 W, 44 MM FP	2920 2932
CAT C15 ACERT		1500 W, 1-3/16" STOR	2907
CAT C11, C13 ACERT		1500 W, 1-5/16" STOR	2905
CATERPILLAR C10, C12		1250 W, 1" NPT	2917
CATERPILLAR 3406E		1500 W, 1" NPT	2908
CATERPILLAR 3406C/E, 3408, DE- TROT DIESEL SE- RIES 50/60 PRE 2007		1000 W, 1" NPT	2944

- Tramec
- Rubber Hose Assemblies
- Coiled Air Assemblies
- 3-in-1 & 4-in-1 Wraps
- Bulk Hose
- Air Compressor Discharge Hose Assemblies
- Quick Fix™
- Air Hose Accessories
- Hose Clamps
- Gladhands & Accessories
- Air Tanks
- Drain Valves
- Ground Plugs
- Truck Valves
- Selector Valves
- Brass Fittings
- Hose & Tube Chart
- Dash Control Valves
- Air Brake Valves
- Air Accessory Valves
- Air Cylinders
- Switches & Toggles
- Plugs, Sockets & Cables
- RV Plugs & Sockets
- Wire & Cable
- Electrical Harnesses
- Electrical Connectors
- Fuel Caps
- Oil Caps & Dipsticks
- Grease Fittings
- Water Pumps
- Wiper Blades
- Engine Heaters**
- Link Cat's Eye®
- Hub Caps, Axilok® & Securex®
- Flitz
- MAXXGreen

# Engine Heaters

APPLICATIONS	ILLUSTRATION	DESCRIPTION	SLOAN PART NO.
CATERPILLAR 3304, 3306, 3176 10.3L		1500 W, 3/4" NPT	2918
CATERPILLAR 3304, 3306, 3176		1250 W, 3/4" NPT	2945
CUMMINS N14 (855)		1500 W, PLATE  1500 W, PLATE NOTE: FLAT PLATE DESIGN WHEN THE 1/2" NPT OPENING IS USED.	2911  2902
N14 (855) CUMMINS		1500 W, PLATE	2904
CUMMINS ISX, SIGNATURE 600, QSX		1500 W, PLATE	2903
CUMMINS ISM, L10		1500 W 38 MM	2919
CUMMINS ISC / ISL, MACK E9, ENDT865/866		1000 W, 3/4"NPT	2916

# Engine Heaters

APPLICATIONS	ILLUSTRATION	DESCRIPTION	SLOAN PART NO.
CUMMINS ISB 5.9L		750 W, 3/4" NPT	2913
CUMMINS BT6, 5.9L		1000 W, FP	2912
CUMMINS 6CT 8.3L		1500 W, FP	2906
CUMMINS 6BT 5.9L		750 W, FP	2929
CUMMINS ISM, 11L		1500 W, PLATE	2909
CUMMINS ENGINE L10, M11 ISM		240 V, 1500 W INSERTS IN THE FORWARD OPENING OF THE HEATER CASTING ON THE RIGHT REAR BLOCK <small>*OIL HEATER THREAD SIZE 1" NPT</small>	2956
NAVISTAR/ INTERNATIONAL INLINE 6 CYLINDER -ALL SERIES 312, 360, 414, 436, 466, 530		120 V, 1500 W MOUNTS IN THE FROST PLUG ON THE LEFT SIDE OF THE ENGINE. FITS ALL SERIES OF THESE ENGINES.	2946

- Tramec
- Rubber Hose Assemblies
- Coiled Air Assemblies
- 3-in-1 & 4-in-1 Wraps
- Bulk Hose
- Air Compressor Discharge Hose Assemblies
- Quick Fix™
- Air Hose Accessories
- Hose Clamps
- Gladhands & Accessories
- Air Tanks
- Drain Valves
- Ground Plugs
- Truck Valves
- Selector Valves
- Brass Fittings
- Hose & Tube Chart
- Dash Control Valves
- Air Brake Valves
- Air Accessory Valves
- Air Cylinders
- Switches & Toggles
- Plugs, Sockets & Cables
- RV Plugs & Sockets
- Wire & Cable
- Electrical Harnesses
- Electrical Connectors
- Fuel Caps
- Oil Caps & Dipsticks
- Grease Fittings
- Water Pumps
- Wiper Blades
- Engine Heaters**
- Link Cat's Eye®
- Hub Caps, Axilok® & Securex®
- Flitz
- MAXXGreen

# Engine Heaters

APPLICATIONS	ILLUSTRATION	DESCRIPTION	SLOAN PART NO.
NAVISTAR DT-466		1250 W, FP	2914
FORD/NAVISTAR 6.9/7.3 L		1000 W, FP	2933
MBE 900		1000 W, PLATE	2942
MACK E7		1500 W, PLATE	2910
MACK MID LINER E3 MS200 & MS250		120 V, 1000 W MOUNTS IN REAR FACE OF BLOCK	2947
MASSEY FERGUSON 3 CYLINDER 4 CYLINDER 6 CYLINDER		120 V, 1000 W 3054B 4023L MOUNTS IN ANY OF THE 1-1/4" FREEZE PLUG OPENINGS IN THE ENGINE	2949
FLUSH MOUNTING KIT FOR TANK HEATERS		120 V, 15 AMPS FOR HEATER WITH WATTAGE OF 500- 1800	2948

# Engine Heaters







APPLICATIONS	ILLUSTRATION	DESCRIPTION	SLOAN PART NO.
OIL PAN HEATER		300 W, 1" NPT OIL PAN	2924
TANK HEATER		1500 W, TANK TYPE	2927
TANK HEATER		1500 W TANK HEATER	2943
STANDARD BATTERY PAD - FOR ONE BATTERY		50 W PAD 75 W PAD	2930 2900
SPECIAL PADS FOR SINGLE BATTERIES		50 W PAD 75 W PAD	2939 2941
DUAL BATTERY PAD FOR MULTIPLE BATTERIES. TO BE USED WITH 2923, 2941, 2936 POWER CORD		50 W PAD 75 W PAD	2938 2940
BATTERY WRAP		28" long 50 W 36" long 80 W 72" long 160 W	2952 2928 2953

- Tramec
- Rubber Hose Assemblies
- Coiled Air Assemblies
- 3-in-1 & 4-in-1 Wraps
- Bulk Hose
- Air Compressor Discharge Hose Assemblies
- Quick Fix™
- Air Hose Accessories
- Hose Clamps
- Gladhands & Accessories
- Air Tanks
- Drain Valves
- Ground Plugs
- Truck Valves
- Selector Valves
- Brass Fittings
- Hose & Tube Chart
- Dash Control Valves
- Air Brake Valves
- Air Accessory Valves
- Air Cylinders
- Switches & Toggles
- Plugs, Sockets & Cables
- RV Plugs & Sockets
- Wire & Cable
- Electrical Harnesses
- Electrical Connectors
- Fuel Caps
- Oil Caps & Dipsticks
- Grease Fittings
- Water Pumps
- Wiper Blades
- Engine Heaters**
- Link Cat's Eye®
- Hub Caps, Axilok® & Securex®
- Flitz
- MAXXGreen



# Engine Heaters

APPLICATIONS	ILLUSTRATION	DESCRIPTION	SLOAN PART NO.
BATTERY PAD CORD		USE WITH DUAL BATTERY PAD	2936
SILICONE HOT PAD		SELF-ADHESIVE PAD	2923
6' POWER CORD 6' POWER CORD 11' POWER CORD		INCLUDES FLIP COVER INCLUDES FLIP COVER	2931 2926 2925
FLIP COVER PLUG HOUSING			2922 2935
HEAT SHIELD			2901

# Link Cat's Eye



## Check Your Tire Pressure in the Blink of an Eye!



“Eye” completely closed, tires are within recommended range and equalized.



Partially open “eye”, tire pressure has dropped 5-6%.



“Eye” completely open, pressure has dropped 10% under the recommended pressure and needs immediate attention. At this point, the internal check valve is activated, isolating the good tire from additional pressure loss.



Stay CSA Compliant!

## \$ Save Money Using The Cat's Eye! \$



- 25% of all dual wheel assemblies have tires that differ in pressure by more than 5 PSI - dragging the smaller tire 13 ft. per mile, on 35,000 miles a year the smaller tire would be dragged 86 miles!
- Proper tire inflation reduces tire cost 10 - 13%
- Save 2- 4% in fuel with proper inflation



Sloan No.	Description
3910	2 Pack Cat's Eye Rubber Hose 95PSI
3911	2 Pack Cat's Eye Rubber Hose 100PSI
3912	2 Pack Cat's Eye Rubber Hose 110PSI
3913	2 Pack Cat's Eye Steel Braided Hose 95PSI
3914	2 Pack Cat's Eye Steel Braided Hose 100PSI
3915	2 Pack Cat's Eye Steel Braided Hose 110PSI
3916	4 Pack Cat's Eye Rubber Hose 95PSI
3917	4 Pack Cat's Eye Rubber Hose 100PSI
3918	4 Pack Cat's Eye Rubber Hose 105PSI
3919	4 Pack Cat's Eye Rubber Hose 110PSI
3920	4 Pack Cat's Eye Steel Braided Hose 95PSI
3921	4 Pack Cat's Eye Steel Braided Hose 100PSI
3922	4 Pack Cat's Eye Steel Braided Hose 105PSI
3923	4 Pack Cat's Eye Steel Braided Hose 110PSI
3934	Steel Hose Straight
3935	Steel Hose 180
3936	Rubber Hose Straight
3937	Rubber Hose 180
3938	Replacement Seals 24 CT.
3940	Point of Purchase Display

- Tramec
- Rubber Hose Assemblies
- Coiled Air Assemblies
- 3-in-1 & 4-in-1 Wraps
- Bulk Hose
- Air Compressor Discharge Hose Assemblies
- Quick Fix™
- Air Hose Accessories
- Hose Clamps
- Gladhands & Accessories
- Air Tanks
- Drain Valves
- Ground Plugs
- Truck Valves
- Selector Valves
- Brass Fittings
- Hose & Tube Chart
- Dash Control Valves
- Air Brake Valves
- Air Accessory Valves
- Air Cylinders
- Switches & Toggles
- Plugs, Sockets & Cables
- RV Plugs & Sockets
- Wire & Cable
- Electrical Harnesses
- Electrical Connectors
- Fuel Caps
- Oil Caps & Dipsticks
- Grease Fittings
- Water Pumps
- Wiper Blades
- Engine Heaters
- Link Cat's Eye®**
- Hub Caps, Axilok® & Securex®
- Flitz
- MAXXGreen



# Hub Caps

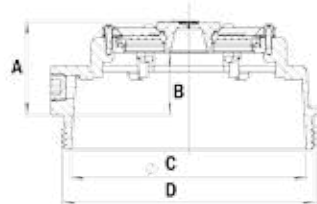
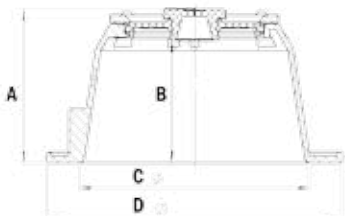

Part Number	Description	Bolt Circle	Bolt Size	No. Of Bolts	A Height	B Inside Depth	C Flange I.D.	D Flange O.D.	Includes	Stemco Number
H340-4095	Hub Cap W/O Side Fill Plug	5-1/2	5/16	6	1-13/16	1-1/16	4-9/16	6-3/16	Gasket	340-4095
H4020	Hub Cap W/O Side Fill Plug	6-1/4 X 8 UN (M)			2-5/16	1-9/16	5-3/4	6-7/8	O-Ring	340-4020 & 340-4975
H4042	Hub Cap W/Side Fill Plug	5-1/8	5/16	6	1-9/20	1-1/8	4	5-11/16	Gasket	343-4042
H4249	Hub Cap W/O Side Fill Plug	5-1/2	5/16	6	1-13/16	1-11/16	4-7/16	6-3/16	Gasket	340-4249
H74009	Hub Cap W/O Side Fill Plug	5-1/2	5/16	6	2-11/16	1-15/16	4-3/8	6-1/4	Gasket	340-4009
H74024	Hub Cap W/O Side Fill Plug	4-1/2	5/16	6	2-5/8	1-7/8	3-1/2	5-1/4	Gasket	340-4024
H74075	Hub Cap W/O Side Fill Plug	6-1/4 X 8 UN (M)			2-5/16	1-9/16	5-3/4	6-7/8	O-Ring	340-4075
H74195	Hub Cap W/O Side Fill Plug	6-3/4	5/16	6	3-11/16	2-15/16	5-7/16	7-1/2	Gasket	340-4195
H84009H	Hub Cap W/Side Fill Plug & Hubodometer	5-1/2	5/16	6	3-12/25	1-15/16	4-3/8	6-1/4	Gasket	347-4009
H84024	Hub Cap W/Side Fill Plug	4-1/2	5/16	6	2-5/8	1-7/8	3-1/2	5-1/4	Gasket	343-4024
H84075	Hub Cap W/Side Fill Plug	6-1/4 X 8 UN (M)			2-5/16	1-9/16	5-3/4	6-7/8	O-Ring	343-4075
H84195	Hub Cap W/Side Fill Plug	6-3/4	5/16	6	3-11/16	2-15/16	5-7/16	7-1/2	Gasket	343-4195

Wheel End Products



## The Axilok® Unitized Wheel Bearing Nut System



The original Axilok® by MacLean-Fogg Components Solutions. Installation should take less than half the time required for the old style, 3-piece-systems. Still greater time savings are realized with Axilok® when adjustments are needed.

- Eliminates the traditional three or four-piece nut system
- Easily adjustable, one-piece assembly for increased speed, accuracy and repeatability
- Uses locking clips to maintain joint security and ensure proper end-play
- Significantly reduces the time required for wheel bearing adjustment
- Delivers accurate results in the process
- Unitized part consisting of nut body, two locking clips and a retainer cage
- Installs with standard, six-sided socket
- Saves installation time
- High degree of accuracy

Part Number	Thread Size	Application, Hex Size (MVS No.)
MF111051	2.625"-16	Trailer & Drive Axle Nut, 3-1/4" Hex (AX-16-2625)
MF111077	3.480"-12	Trailer Axle Nut, 4-1/8" Hex (AX-12-3480)
MF111062	3.250"-12	Drive Axle Nut, 4" Hex (AX-12-3250)
MF111099	1.500"-12	Steer Axle Nut, 2-1/8" Hex (AX-12-1500)
MF111010	1.500"-18	Steer Axle Nut, 2-1/8" Hex (AX-18-1500)

## The Securex® Wheel Nut

- Name forged into washer assures product integrity
- Heat lot traceability code on every fastener
- PTFE coating reduces friction, enhances corrosion-protection
- Meets SAE J1965 requirement for torque tension
- North American Manufacturing



Part Number	Thread Size	Type & Finish
MF110343	M22 x 1.5	33mm Flangette Hex (31mm Hi), Flat Washer, PTFE
MF111026	M22 x 1.5	33mm Hex, Flat Washer, PTFE

- Tramec
- Rubber Hose Assemblies
- Coiled Air Assemblies
- 3-in-1 & 4-in-1 Wraps
- Bulk Hose
- Air Compressor Discharge Hose Assemblies
- Quick Fix™
- Air Hose Accessories
- Hose Clamps
- Gladhands & Accessories
- Air Tanks
- Drain Valves
- Ground Plugs
- Truck Valves
- Selector Valves
- Brass Fittings
- Hose & Tube Chart
- Dash Control Valves
- Air Brake Valves
- Air Accessory Valves
- Air Cylinders
- Switches & Toggles
- Plugs, Sockets & Cables
- RV Plugs & Sockets
- Wire & Cable
- Electrical Harnesses
- Electrical Connectors
- Fuel Caps
- Oil Caps & Dipsticks
- Grease Fittings
- Water Pumps
- Wiper Blades
- Engine Heaters
- Link Cat's Eye®
- Hub Caps, Axilok® & Securex®
- Flitz
- MAXXGreen

## Metal, Plastic & Fiberglass Polish - Paste



Sloan No.	Description
2700	.07 oz Packet in Jar Display (100 per Jar)
2701	1.76 oz Blister Tube
2702	5.29 oz Boxed Tube
2703	2.0 lb Quart Can
2704	1 Gallon Can



A Concentrated Cream That Is Unsurpassed In Its Ability To Clean, Polish, Deoxidize And Protect. Nothing Works Faster, Easier Or Better.

**Use On:** Brass, Copper, Silverplate, Sterling Silver, Chrome, Stainless Steel. **Removes:** Tarnish, Rust, Water Stains, Chalking, Lime Deposits, Heat Discoloration

## Stainless Steel & Chrome Cleaner With Degreaser



Sloan No.	Description
2706	1.7 oz Spray Bottle
2707	16 oz Spray Bottle
2708	1 Gallon



**Instantly & Easily Removes:** Fingerprints, Oil, Grease, Brake Dust, Soil Wax, Soap, Automotive Fluids & More.

**Safe On:** Brushed Or Polished Stainless Steel, Chrome, Painted Surfaces, Plastics, Acrylics.

**Brake Dust:** Spray On And Let Sit To Allow Degreaser To Penetrate Greasy Residue/Brake Dust. Wipe Away With Soft Cloth Or Buffer

## Stainless Steel & Chrome Polish



Sloan No.	Description
2709	1.7 oz Spray Bottle
2710	16 oz Spray Bottle
2711	1 Gallon



A Premium, Water-Based Polish. Leaves A Brilliant, Protective Gloss. Dust & Fingerprint Resistant.

**Safe On:** Brushed Or Polished Stainless Steel: Appliances, Gas Grills, Vent Hoods & More. Chrome, Painted Surfaces, Plastics, & Acrylics.

**Use:** Spray On And Wipe With Soft Cloth Along The Grain.

## Magnesium Chloride Remover



Sloan No.	Description
2722	16 oz Spray Bottle
2723	1 Gallon
2724	5.5 Gallon Tote



**Prevent & Maintain:** Instantly Remove The Harsh Corrosion Caused By Magnesium Chloride & Calcium Chloride, Brake Dust, Calcium, Lime, Grease, Oil & Water Stains From Aluminum & Stainless Steel.

**Use:** Simply Spray On, Agitate And Rinse. Will Not Dull Aluminum. Safe For Use On Painted Surfaces, Fiberglass & Chrome



## X-treme Stainless Steel Clean - Heavy Build-Up Remover



Sloan No.	Description
2712	16 oz Spray Bottle
2713	1 Gallon
2714	5.5 Gallon Tote



Created For X-Treme Corrosion, Grease Build Up  
**Removes:** Heavy Grease Build Up, Mold, Rust, Calcium, Lime, Corrosion  
**Safe On:** Stainless Steel, Chrome, Aluminum, Brass & Copper  
**Use:** Spray Directly Onto Surface; Wait Up To 1 Minute. Scrub With Nylon Brush.  
 Do Not Let Product Dry - Rinse Well With Water

## Instant Battery Terminal Corrosion Remover



Sloan No.	Description
2729	16 oz Spray Bottle



**Instantly Removes:** Rust & Corrosion From Battery Terminals. Removes Diesel Stains, Oil, Grease, And Encrusted Calcium & Lime.  
**Safe On:** Aluminum, Copper, Brass & Lead Terminals.  
**Use:** Spray Directly Onto The Terminal Corrosion. Let Sit 5-10 Seconds. Scrub With Small Nylon Brush & Rinse.

## Instant Calcium, Rust & Lime Remover



Sloan No.	Description
2717	16 oz Spray Bottle
2718	1 Gallon



**Instantly Removes:** Hard Water Spots & Rust Stains Caused By Sprinklers, Calcium Deposits & Stains, Soap Scum, Lime Deposits, Corrosion, Tarnish, Grease & Oil.  
**Safe On:** Glass, Aluminum, Painted Surfaces, Fiberglass, Stucco, Brick, Porcelain, Brass & Copper  
**Warning:** Not Suitable For Chrome.

## Instant Brass & Copper Tarnish Remover



Sloan No.	Description
2715	16 oz Spray Bottle
2716	1 Gallon



**Instantly Removes:** Heavy Tarnish Without Rubbing. Safer Than Traditional Acid-Based Cleaners.  
**Safe On:** Brass & Copper, Glass, Aluminum, Painted Surfaces, Fiberglass, Stucco, Brick, Porcelain.  
**Use:** Just Spray & Rinse



- Tramec
- Rubber Hose Assemblies
- Coiled Air Assemblies
- 3-in-1 & 4-in-1 Wraps
- Bulk Hose
- Air Compressor Discharge Hose Assemblies
- Quick Fix™
- Air Hose Accessories
- Hose Clamps
- Gladhands & Accessories
- Air Tanks
- Drain Valves
- Ground Plugs
- Truck Valves
- Selector Valves
- Brass Fittings
- Hose & Tube Chart
- Dash Control Valves
- Air Brake Valves
- Air Accessory Valves
- Air Cylinders
- Switches & Toggles
- Plugs, Sockets & Cables
- RV Plugs & Sockets
- Wire & Cable
- Electrical Harnesses
- Electrical Connectors
- Fuel Caps
- Oil Caps & Dipsticks
- Grease Fittings
- Water Pumps
- Wiper Blades
- Engine Heaters
- Link Cat's Eye®
- Hub Caps, Axilok® & Securex®
- Flitz
- MAXXGreen

## Aluminum PreClean; Industrial Strength



Sloan No.	Description
2719	16 oz Spray Bottle
2720	1 Gallon
2721	5.5 Gallon Tote



**Instantly Removes:** Hard Water Spots & Rust Stains, Calcium Deposits & Stains, Soap Scum, Lime Deposits, Corrosion, Tarnish, Grease & Oil. Nonflammable. Use Indoors Or Out.

**Safe On:** Glass, Aluminum, Painted Surfaces, Fiberglass, Brass & Copper. Won't Haze Aluminum. Not Suitable For Chrome.

**Use:** Spray On, Agitate And Rinse.

## Speed Waxx - Super Gloss High Performance Spray



Sloan No.	Description
2725	1.7 oz Spray Bottle
2726	16 oz Spray Bottle
2727	1 Gallon
2728	5.5 Gallon Tote



Premium-Grade Detailing Spray That's Perfect For When You're In A Hurry And Need A Super-Fast Super Shine.

**Exceptional Performance On:** Enamel And Painted Surfaces, Clearcoat, Gelcoat, Lacquer, Polyurethane, Fiberglass, Ceramic & Powder Coatings, Plexiglass, Eisenglass, Acrylics And Plastics.

**Use:** Spray-On, Wipe-Off Wax

## Gun Bore Cleaner



Sloan No.	Description
2705	7.6 oz Bottle



Cleaner Will Remove The Plastic Wad, Copper & Powder Fouling that Is Not Visible To The Naked Eye, But Must Be Removed To Maintain The Accuracy Of Your Firearm

**Safe On:** Factory Gun Bluing, Stainless & Nickel Firearms.

## Rifle & Gun Waxx



Sloan No.	Description
2730	7.6 oz Bottle



**Polishes And Protects:** Against Fingerprints, Powder Residue, Rust, Blood, Water Spots, Salt Deposits, Lime Deposits And Tree Sap.

**Safe On:** Gun Bluing, Polished, Plastic & Hand-Rubbed Wood Stocks, Stainless Or Nickel Firearms And Blades. Safe On Interior And Exterior Of The Bore.

## Mini Scuff Pads



Sloan No.	Description
2760	1000 grit, size: 2.75" x 2.75" (6 Pack)

**Design:** Non-Woven Abrasives Are Three Dimensional Media Made With Cut Fiber Strands; Coated With Resin And Abrasive. Flexible & Durable. Ideal For Contoured Surfaces.

**Removes** Heavy Oxidized Clearcoat On Headlights And On Plastics.

**Use On:** Plastics, Acrylic, Wood, Composite & More



## Original Buff Balls



Sloan No.	Description
2761	Super Mini 2" in Clamshell
2762	Large, Orange 5" in Clamshell
2763	X-Large, Blue 7" in Clamshell

**Use On:** All Surfaces. Quickly And Safely Buffs Out Brake Dust, Scuff Marks, Light Scratches, Oxidation, Chalking, Tarnish, Pitting & Corrosion.

**Design:** Begins As A Flat Buff Pad, But Turns Into A Buffball As It Spins On The Drill.

## Flitz Kits



Sloan No.	Description
2770	<b>Headlight Restoration Kit</b> Includes: 1 each: 7" BuffBall, 1.76oz tube Polish/Paste, 1.7oz Speed Wax bottle, Scuff Pad, Coupon for free microfiber cloth
2771	<b>Mag Wheel Restoration Kit</b> Includes: 1 each: 5" BuffBall, 1.76oz tube Metal Polish, 1.7oz Speed Wax, Coupon for free microfiber cloth
2772	<b>Heavy Duty / Truck Polishing Kit</b> Includes: 1 each: 7" BuffBall, 5.29oz tube Polish/Paste, 1.7oz Speed Wax, 1-Scuff Pad, Coupon for free microfiber cloth
2773	<b>Diamond Plate Restoration Kit - for Truck Toolboxes</b> Includes: 1 each: 5" BuffBall, 1.76oz tube Metal Polish, 1.7oz Speed Wax, Coupon for free microfiber cloth
2774	<b>Motorcycle Detailing Kit</b> Includes: 1 each: 2" BuffBall, 1.76oz tube Metal Polish, 1.7oz Speed Wax, Coupon for free microfiber cloth
2775	<b>Cycle 2Go Care Kit</b> Includes: 1.76oz Paste Metal Polish, 1.7oz Stainless Cleaner, 1.7oz Speed Wax, Microfiber Cloth & Black Carry-Along Pouch
2776	<b>Knife &amp; Gun Care Kit</b> Includes: 1.76oz Paste Metal Polish, 1.7oz Stainless Cleaner, 1.7oz Rifle/Gun Wax, & Microfiber Cloth



## P.O.P Items



Sloan No.	Description
2790	Digital Video Players Motion Sensored Digital Video Player w/ 7" screen, electric powered, remote
2793	P.O.P. Displays Black, Cardboard Floor Display with Flitz full color logo graphics. 3 shelves



- Tramec
- Rubber Hose Assemblies
- Coiled Air Assemblies
- 3-in-1 & 4-in-1 Wraps
- Bulk Hose
- Air Compressor Discharge Hose Assemblies
- Quick Fix™
- Air Hose Accessories
- Hose Clamps
- Gladhands & Accessories
- Air Tanks
- Drain Valves
- Ground Plugs
- Truck Valves
- Selector Valves
- Brass Fittings
- Hose & Tube Chart
- Dash Control Valves
- Air Brake Valves
- Air Accessory Valves
- Air Cylinders
- Switches & Toggles
- Plugs, Sockets & Cables
- RV Plugs & Sockets
- Wire & Cable
- Electrical Harnesses
- Electrical Connectors
- Fuel Caps
- Oil Caps & Dipsticks
- Grease Fittings
- Water Pumps
- Wiper Blades
- Engine Heaters
- Link Cat's Eye®
- Hub Caps, Axilok® & Securex®
- Flitz
- MAXXGreen



## Environmentally Friendly Products

### MAXXClean Super Concentrate Degreaser

MAXXClean Super Concentrate has been formulated in partnership with the U.S. Environmental Protection Agency to provide a safer, more environmentally preferable alternative to existing cleaning products without sacrificing performance.

This highly concentrated, versatile cleaner is formulated to take on a wide range of cleaning jobs. It is able to quickly power off even stubborn soils and greases from any surface not harmed by water. Dilute it in a pail or pressure washer to wash vehicles and shop equipment, in spray bottles for glass, chrome and stainless steel, and in mop buckets or floor scrubbers.



#### One 5 oz. Pouch will make

- 1 Quart of Super Degreaser or
- 5 Gallons of Vehicle Wash or
- 10 Gallons of Window & Glass Cleaner

#### One 15 oz. Pouch will make

- 3 Quart of Super Degreaser or
- 15 Gallons of Vehicle Wash or
- 30 Gallons of Window & Glass Cleaner

Sloan	
No.	Description
1101	1 Gallon Vehicle Wash (Super Concentrate)
1102	5 Gallon Vehicle Wash (Super Concentrate)
1201	1 Quart Super Degreaser
1202	1 Gallon Super Degreaser
1301	1 Quart Window & Glass Cleaner
1302	1 Gallon Window & Glass Cleaner
1401	5 Oz Super Concentrate Pouches
1402	15 Oz Super Concentrate Pouches
2500	MAXXAbsorb 7 Pound Bag
2501	MAXXAbsorb 20 Pound Bag
2503	MAXXAbsorb 5 FT Boom
2504	MAXXAbsorb 10 FT Boom

• MSDS Sheet Available Upon Request



MAXXGreen



Absorbs 4X More  
Than Clay

## MAXXAbsorb Universal Organic Absorbent

MAXXAbsorb is the safe, green choice for clean up of hazardous liquid spills, including oils, fuels, solvents and chemicals.

MAXXAbsorb works better and faster, and it absorbs more:

- Landfill-Safe
- Contains no chemicals or pesticides
- Will separate oil from water
- Work place and environment safe
- Contains no harmful dusts
- Lower response time; absorbs 90% capacity in under 10 minutes



Sloan No.	Description
2500	MAXXAbsorb 7 Pound Bag
2501	MAXXAbsorb 20 Pound Bag
2503	MAXXAbsorb 5 FT Boom
2504	MAXXAbsorb 10 FT Boom

\* MSDS Sheet Available Upon Request

### Cost To Clean Up 1 Gallon Spill\*

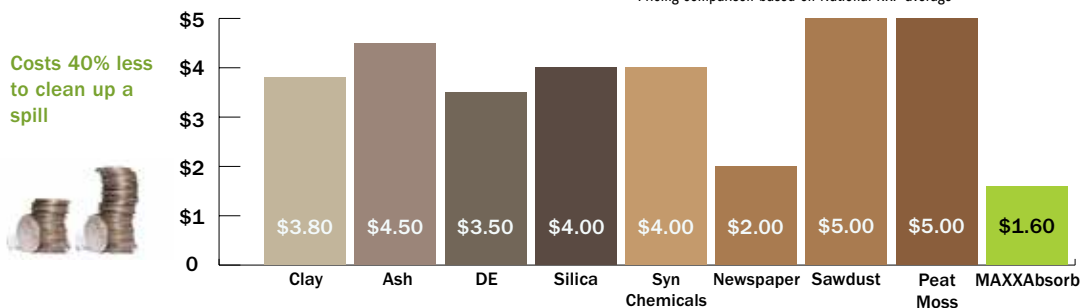

### Amount Of Absorbent Required For 1 Gallon Spill

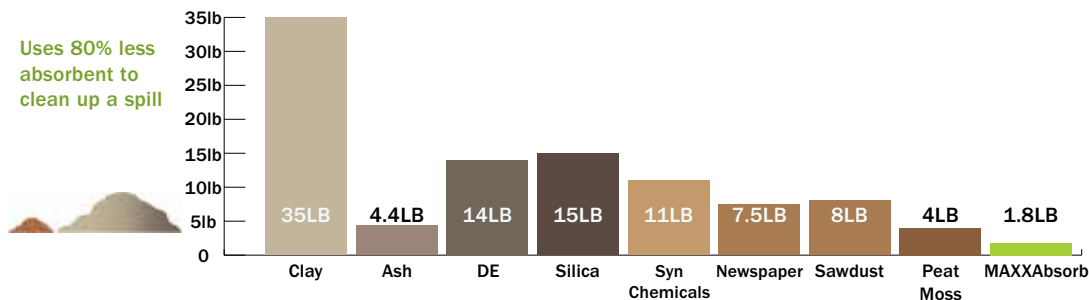

### Down Time To Cleanup a 50 Gallon Spill

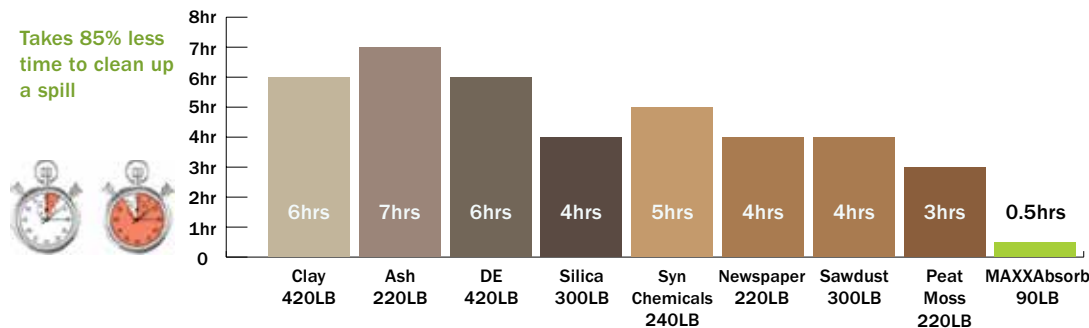

Very low disposal cost

- Tramec
- Rubber Hose Assemblies
- Coiled Air Assemblies
- 3-in-1 & 4-in-1 Wraps
- Bulk Hose
- Air Compressor Discharge Hose Assemblies
- Quick Fix™
- Air Hose Accessories
- Hose Clamps
- Gladhands & Accessories
- Air Tanks
- Drain Valves
- Ground Plugs
- Truck Valves
- Selector Valves
- Brass Fittings
- Hose & Tube Chart
- Dash Control Valves
- Air Brake Valves
- Air Accessory Valves
- Air Cylinders
- Switches & Toggles
- Plugs, Sockets & Cables
- RV Plugs & Sockets
- Wire & Cable
- Electrical Harnesses
- Electrical Connectors
- Fuel Caps
- Oil Caps & Dipsticks
- Grease Fittings
- Water Pumps
- Wiper Blades
- Engine Heaters
- Link Cat's Eye®
- Hub Caps, Axilok® & Securex®
- Flitz
- MAXXGreen

Part Number	Page Number	Part Number	Page Number	Part Number	Page Number	Part Number	Page Number	Part Number	Page Number
OCT2023XX	30	371SP-8-4-8	93	2760	238	2956	229	6093	209
OCTR009XX	30	450XX	27	2761	239	3910	233	6101	211
4A0XX	26	451XX	27	2762	239	3911	233	6102	211
4A1XX	26	452XX	27	2763	239	3912	233	6103	211
4A2XX	26	453XX	27	2770	239	3913	233	6104	211
4A3XX	26	460XX	27	2771	239	3914	233	6113	211
4AAXX	28	461XX	27	2772	239	3915	233	6114	212
4ABXX	28	462XX	27	2773	239	3916	233	6117	214
4ACXX	25	463XX	27	2774	239	3917	233	6119	212
4ADXX	25	470XX	27	2775	239	3918	233	6122	212
4AJXX	25	471XX	27	2776	239	3919	233	6123	214
4AKXX	25	472XX	27	2790	239	3920	233	6124	214
4B0XX	26	473XX	27	2793	239	3921	233	6125	212
4B1XX	26	480XX	27	2900	231	3922	233	6126	213
4B2XX	26	481XX	27	2901	232	3923	233	6127	214
4B3XX	26	482XX	27	2902	228	3934	233	6128	213
4BAXX	28	483XX	27	2903	228	3935	233	6129	213
4BBXX	28	1101	240	2904	228	3936	233	6130	213
4BCXX	25	1102	240	2905	227	3937	233	6131	212
4BDXX	25	1201	240	2906	229	3938	233	6132	212
4BJXX	25	1202	240	2907	227	3940	233	6133	212
4BKXX	25	1301	240	2908	227	05511XX	30	6205	216
4C0XX	26	1302	240	2909	229	05545XX	30	6208	216
4C1XX	26	1401	240	2910	230	6001	205	6217	216
4C2XX	26	1402	240	2911	228	6002	205	6219	216
4C3XX	26	2500	240	2912	229	6004	205	6220	217
4CAXX	28	2501	240	2913	229	6006	205	6301	214
4CBXX	28	2503	240	2914	230	6010	205	6302	215
4CCXX	25	2504	240	2915	227	6012	205	6304	213
4CDXX	25	2616	222	2916	228	6013	206	6305	215
4CJXX	25	2618	222	2917	227	6014	206	6306	215
4CKXX	25	2620	222	2918	228	6015	206	6307	215
4D0XX	26	2622	222	2919	228	6016	206	6309	213
4D1XX	26	2624	222	2920	227	6017	206	6310	213
4D2XX	26	2700	236	2922	232	6018	207	6311	214
4D3XX	26	2701	236	2923	232	6019	206	6313	215
4DAXX	28	2702	236	2924	231	6020	206	6314	214
4DBXX	28	2703	236	2925	232	6051	207	6315	215
4DCXX	25	2704	236	2926	232	6052	207	6316	215
4DDXX	25	2705	238	2927	231	6053	208	6317	216
4DJXX	25	2706	236	2928	231	6058	207	6350	217
4DKXX	25	2707	236	2929	229	6059	208	6352	218
37SP-4-6	93	2708	236	2930	231	6061	207	6353	216
37SP-6-4	93	2709	236	2931	232	6064	207	6354	216
45AXX	29	2710	236	2932	227	6068	208	6355	217
45BXX	29	2711	236	2933	230	6069	207	6356	217
46AXX	29	2712	237	2935	232	6070	208	6357	217
46BXX	29	2713	237	2936	232	6071	208	6358	217
47AXX	29	2714	237	2937	227	6073	208	6359	217
47BXX	29	2715	237	2938	231	6074	208	6360	205
48AXX	29	2716	237	2939	231	6075	209	6361	218
48BXX	29	2717	237	2940	231	6076	209	6362	218
126-4-6	106	2718	237	2941	231	6077	210	6716	220
254PMT-6-4	92	2719	238	2942	230	6078	209	6717	220
254PMT-12-8	92	2720	238	2943	231	6081	210	6718	220
369SP-4-4	93	2721	238	2944	227	6082	210	6719	220
369SP-4-6	93	2722	236	2945	228	6083	210	6720	220
369SP-6-4	93	2723	236	2946	229	6084	210	6721	220
369SP-6-6	93	2724	236	2947	230	6086	210	6722	220
369SP-6-8	93	2725	238	2948	230	6087	209	6724	220
369SP-8-8	93	2726	238	2949	230	6088	211	6726	220
371SP-4-4	93	2727	238	2951	226	6089	211	6728	220
371SP-4-6	93	2728	238	2952	231	6090	209	6811	221
371SP-6-4-6	93	2729	237	2953	231	6091	210	6811B	222
371SP-6-6	93	2730	238	2954	226	6092	209	6811F	223

# Index



Part Number	Page Number	Part Number	Page Number	Part Number	Page Number	Part Number	Page Number	Part Number	Page Number
6812	221	31305	5	34014	17	34269	16	36406	18
6812B	222	31306	5	34015	17	34270	16	36407	18
6812F	223	31402	3	34017	17	34271	16	36413	18
6812FX	223	31403	3	34019	4	34275	15	36416	18
6813	221	31407	3	34020	17	34287	15	36420	18
6813B	222	31408	4	34021	17	35000	22	36430	9
6813F	223	31409B	4	34022	17	35001-064	22	36440	9
6814	221	31410	4	34033	4	35002-048	22	38013	42
6814B	222	31502-XXX	6	34037	4	35002-060	22	38033	42
6814F	223	31503-XXX	6	34051	16	35006-048	22	38035	42
6814FX	223	31505-XXX	6	34056	16	35006-060	22	38042	42
6815	221	31506-XXX	6	34058	16	35007	22	38043	42
6815B	222	31509-XXX	6	34060	16	35007-048	22	38044	42
6815F	223	31512-XXX	6	34061	16	35007-060	22	38046	42
6815FX	223	31540-XXX	9	34063	16	35007U060	22	38053	42
6816	221	31550-XXX	9	34074	14	35008	22	38181	41
6816B	222	32001-XXX	7	34075	14	35013	22	38181-12	41
6816F	223	32002-XXX	7	34076	14	35017	22	38181-15	41
6816FX	223	32003-XXX	7	34076A	14	35901	22	38194	41
6817	221	32005-XXX	7	34077	14	35903	22	38195	41
6817B	222	32006-XXX	7	34077A	14	35905	22	38196	41
6817F	223	32007-XXX	7	34078	14	35907	22	38196-08	41
6818	221	32008-XXX	7	34079	14	35909	22	38196-10	41
6818B	222	32009-XXX	7	34080	14	36001	18	38196-12	41
6818F	223	32010-XXX	7	34081	14	36002	18	38196-15	41
6818FX	223	32011-XXX	7	34082	14	36003	18	38197	40
6819	221	32012-XXX	7	34083	14	36010	18	38198	40
6819B	222	32201-XXX	8	34084	14	36011	18	38200	31
6819F	223	32202-XXX	8	34085	14	36012	18	38202	31
6820	221	32205-XXX	8	34086	14	36015	18	38204	39
6820B	222	32206-XXX	8	34087	14	36016	18	38210	31
6820F	223	32301-XXX	8	34088	14	36017	18	38211	31
6820FX	223	32302-XXX	8	34089	14	36101	19	38212	31
6821	221	32305-XXX	8	34089A	14	36131	21	38213	31
6821B	222	32319-XXX	8	34090	14	36131P	21	38214	31
6821F	223	32320-XXX	8	34090A	14	36153	21	38215	31
6822	221	32502-XXX	7	34091	14	36154	21	38216	31
6822B	222	32503-XXX	7	34092	14	36156	21	38217	31
6822F	223	32505-XXX	7	34093	7	36159	21	38260	32
6822FX	223	32506-XXX	7	34094	7	36161	21	38260B	32
6824	221	32509-XXX	7	34097	14	36161P	21	38265	32
6824B	222	32512-XXX	7	34098	7	36181	20	38265B	32
6824FX	223	32516-XXX	7	34114	17	36182	20	38282	36
6826	221	32801-XXX	8	34117	17	36191	20	38283	36
6826B	222	32802-XXX	8	34118	17	36192	20	38290	36
6826FX	223	33009	4	34150	17	36201	19	38292	36
6828	221	33010	4	34160	16	36231	21	38296	36
6828B	222	33011	4	34161	16	36231P	21	38298	36
6828FX	223	33012	4	34170	16	36253	21	38304	30
6832FX	223	33013	4	34171	16	36254	21	38305	30
9940	224	33014	4	34200	15	36256	21	38306	30
9941	224	33015	4	34211	15	36261	21	38307	30
9942	224	33016	4	34212	15	36261P	21	38310	31
31002	5	33018	4	34213	15	36281	20	38312	31
31002-XXX	6	34001	14	34220	15	36282	20	38340	31
31003-XXX	6	34001A	14	34228	16	36291	20	38341	31
31005	5	34002	14	34229	16	36292	20	38342	31
31005-XXX	6	34002A	14	34241	15	36301	19	38343	31
31006-XXX	6	34003	14	34246	16	36380	20	38344	31
31009-XXX	6	34003A	14	34247	16	36385	20	38345	31
31012-XXX	6	34009	17	34250	15	36390	20	38350	31
31102	5	34010	17	34251	15	36395	20	38351	31
31105	5	34011	17	34259	15	36401	18	38360	31
31302	5	34012	17	34260	15	36403	18	38361	31
31303	5	34013	17	34268	16	36405	18	38394	36

Part Number	Page Number	Part Number	Page Number	Part Number	Page Number	Part Number	Page Number	Part Number	Page Number
38395	36	38815	38	55286	20	401150	144	401235	133
38396	36	38820	38	55287	20	401151	144	401236	133
38397	36	38821	38	55290	20	401152	141	401237	129
38402-04	37	38822	38	55291	20	401153	141	401238	149
38403-04	37	38823	38	56101	19	401154	141	401239	149
38407-04	37	38824	38	56121	19	401155	141	401240	149
38408-04	37	38825	38	56161	21	401156	141	401241	149
38410-04	37	38830	38	56181	20	401157	142	401242	147
38412-04	37	38831	38	56191	20	401158	142	401243	147
38440	31	38832	38	56201	19	401159	142	401244	124
38441	31	38833	38	56221	19	401160	142	401245	124
38442	31	38834	38	56261	21	401161	142	401246	124
38443	31	38835	38	56281	20	401162	142	401247	124
38444	31	38844	30	56291	20	401163	142	401248	124
38445	31	38845	30	56301	19	401164	143	401250	124
38450	31	38848	30	56321	19	401165	143	401252	124
38451	31	38849	30	59000	18	401166	126	401253	143
38452	32	38860	38	59001	18	401167	126	401254	143
38453	32	38861	38	400256	147	401168	131	401255	143
38460	32	50001	13	400258	147	401169	132	401256	143
38461	32	50002	13	400356	147	401170	131	401257	143
38462	32	50003	13	400358	147	401171	126	401261	148
38463	32	50004	13	401004	87	401176	130	401262	148
38464	32	50005	13	401005	87	401177	130	401263	148
38465	32	50006	13	401008	126	401178	122	401267	147
38491	41	50007	13	401009	126	401180	122	401268	136
38492	36	50008	13	401011	126	401181	127	401269	133
38494	41	50009	13	401012	126	401182	132	401270	133
38496	41	50010	13	401017	126	401183	134	401271	135
38497	40	50011	13	401018	126	401184	134	401272	135
38501	33	50012	13	401019	126	401185	134	401274	131
38502	33	50013	13	401029	123	401186	134	401275	129
38520	33	50016	13	401032	123	401187	134	401279	128
38521	33	50016A	13	401035	123	401188	134	401280	128
38526	33	50017	13	401039	125	401189	134	401281	135
38527	33	50018	13	401040	123	401190	144	401282	135
38540	34	50019	13	401045	87	401201	132	401283	135
38541	34	50027	13	401046	87	401202	132	401284	135
38550-15	34	51100	23	401047	87	401206	128	401285	135
38550-20	34	51101	23	401070	87	401207	127	401286	127
38550-30	34	51102	23	401075	87	401209	123	401287	127
38551-15	34	51103	23	401084	123	401210	131	401288	127
38551-20	34	51104	23	401086	87	401211	129	401289	137
38551-30	34	51106	23	401094	87	401212	128	401290	137
38560	34	51107	23	401095	87	401213	129	401291	137
38561	34	51110	23	401130	130	401214	149	401292	134
38601	40	51140	23	401131	130	401215	149	401293	135
38701	40	51142	23	401132	131	401216	133	401297	137
38704	39	51143	23	401133	130	401217	146	401299	137
38705	36	51155	23	401134	122	401218	146	401301	137
38706	36	51156	23	401135	122	401219	146	401303	137
38707	33	51157	23	401136	122	401220	130	401304	144
38714	39	51158	23	401137	122	401221	136	401305	145
38720	33	51301	24	401138	141	401222	136	401306	145
38800	38	51305	24	401139	141	401223	136	401307	145
38801	38	51321	24	401140	141	401224	136	401308	143
38802	38	51325	24	401141	141	401225	136	401311	142
38803	38	55100B	9	401142	129	401226	132	401315	87
38804	38	55100R	9	401143	128	401227	132	401328	139
38805	38	55101B	9	401144	128	401228	127	401329	139
38810	38	55101R	9	401145	128	401229	132	401330	139
38811	38	55103B	9	401146	128	401230	150	401331	139
38812	38	55103R	9	401147	144	401232	124	401332	139
38813	38	55243	20	401148	142	401233	124	401333	139
38814	38	55244	20	401149	144	401234	133	401334	139

# Index



Part Number	Page Number	Part Number	Page Number	Part Number	Page Number	Part Number	Page Number	Part Number	Page Number
401335	139	421143	157	421215	162	422028	179	422097	185
401336	139	421144	157	421216	162	422029	179	422098	185
401337	140	421145	163	421217	162	422030	179	422099	185
401338	140	421146	163	421218	162	422031	179	422100	185
401339	140	421147	158	421225	162	422032	179	422101	185
401340	140	421148	158	421226	162	422033	179	422102	185
401341	140	421149	156	421227	162	422034	179	422103	185
401342	140	421150	156	421228	162	422035	179	422104	185
401343	140	421151	159	421229	162	422036	179	422105	184
401344	140	421152	157	421230	162	422037	179	422106	184
401345	140	421153	157	421231	162	422038	179	422107	184
401346	140	421155	161	421232	162	422039	179	422108	184
401347	140	421156	161	421233	162	422040	179	422109	184
401705	125	421157	161	421234	162	422041	179	422110	184
401708	125	421159	162	421235	162	422042	179	422111	184
401710	125	421160	162	421236	163	422043	179	422112	184
401712	125	421162	158	421237	159	422044	180	422113	186
401714	125	421163	156	421246	160	422045	180	422114	186
401716	125	421164	163	421247	161	422046	180	422115	186
401725	125	421165	163	421272	157	422047	180	422116	186
401727	125	421166	161	421283	157	422048	178	422117	186
401729	87	421167	161	421284	157	422049	178	422118	186
401730	87	421168	157	421286	157	422050	178	422119	186
401747	148	421170	159	421287	157	422051	178	422120	186
401748	148	421171	157	421296	58	422052	178	422121	186
401749	148	421172	163	421297	58	422053	178	422122	186
401777	141	421173	163	421298	58	422054	178	422123	187
401778	141	421174	159	421300	58	422055	178	422124	187
402256	147	421175	159	421301	58	422056	181	422125	187
403256	147	421176	156	421302	58	422057	181	422126	187
403258	147	421177	158	421749	157	422058	181	422128	185
403358	147	421178	162	421758	160	422059	181	422129	187
421000	158	421179	162	421808	182	422060	181	422130	187
421001	158	421180	163	421809	182	422061	181	422131	185
421007	162	421181	163	421810	182	422062	180	422133	185
421010	163	421182	163	421998	195	422063	180	422134	185
421015	156	421183	163	421999	195	422064	181	422135	185
421019	157	421184	163	422000	179	422069	181	422136	185
421021	157	421185	162	422001	179	422070	181	422137	185
421053	157	421187	163	422002	179	422071	182	422138	185
421113	163	421188	163	422003	179	422072	182	422139	185
421115	162	421189	163	422004	179	422073	182	422140	185
421119	156	421190	163	422005	179	422074	182	422141	185
421120	157	421191	163	422006	179	422075	182	422142	185
421121	156	421192	163	422007	179	422076	182	422143	185
421122	159	421193	163	422008	179	422077	182	422144	185
421123	156	421194	163	422009	179	422078	182	422145	189
421124	156	421195	163	422010	179	422079	182	422146	189
421126	157	421196	163	422011	181	422080	182	422147	189
421127	159	421197	163	422012	181	422081	182	422148	189
421128	160	421198	163	422013	181	422082	184	422149	189
421129	161	421199	161	422014	181	422083	184	422150	189
421130	161	421200	161	422015	180	422084	184	422151	189
421131	164	421201	161	422016	180	422085	184	422152	189
421132	165	421202	161	422017	180	422086	184	422153	191
421133	164	421203	161	422018	179	422087	184	422154	191
421134	165	421204	161	422019	179	422088	184	422155	191
421135	159	421205	161	422020	179	422089	184	422156	191
421136	156	421206	161	422021	181	422090	184	422157	191
421137	164	421207	161	422022	181	422091	184	422158	191
421138	164	421208	161	422023	180	422092	184	422159	183
421139	165	421209	161	422024	180	422093	184	422160	183
421140	151	421210	161	422025	179	422094	185	422161	183
421141	157	421213	162	422026	179	422095	185	422162	183
421142	157	421214	162	422027	179	422096	185	422163	183

Part Number	Page Number	Part Number	Page Number	Part Number	Page Number	Part Number	Page Number	Part Number	Page Number
422164	183	422230	169	422290	167	422368	178	422436	179
422165	183	422231	169	422290-1000	167	422369	178	422437	179
422166	183	422232	169	422291	167	422370	178	422438	179
422167	183	422233	169	422291-1000	167	422371	178	422439	179
422168	183	422234	169	422292	167	422372	178	422440	178
422169	183	422240	172	422292-1000	167	422373	178	422441	178
422170	183	422241	166	422293	167	422374	178	422442	178
422171	183	422242	166	422293-1000	167	422375	178	422443	178
422172	183	422243	166	422294	167	422376	178	422444	178
422173	183	422244	166	422294-1000	167	422377	178	422445	178
422174	183	422245	166	422295	167	422378	181	422446	178
422175	183	422246	166	422295-1000	167	422379	181	422447	178
422176	189	422247	166	422296	168	422380	181	422448	180
422177	189	422248	166	422296-1000	168	422381	181	422449	180
422178	189	422249	166	422297	168	422382	181	422450	180
422179	189	422250	166	422297-1000	168	422383	181	422451	180
422180	189	422251	166	422298	168	422387	181	422454	181
422181	189	422252	166	422298-1000	168	422388	181	422455	181
422182	189	422253	166	422299	168	422389	181	422458	181
422183	189	422254	166	422299-1000	168	422390	181	422459	181
422184	189	422255	166	422300	168	422391	181	422460	181
422185	189	422256	166	422300-1000	168	422392	181	422461	181
422186	189	422257	166	422301	168	422393	186	422462	181
422187	189	422258	166	422302	168	422394	186	422463	181
422188	189	422259	166	422303	168	422395	186	422464	180
422189	189	422260	166	422304	168	422396	186	422465	180
422190	189	422261	166	422305	168	422397	186	422466	180
422191	189	422262	166	422306	168	422398	186	422467	180
422192	190	422263	166	422307	168	422399	186	422471	169
422193	190	422264	166	422308	168	422400	186	422472	170
422194	190	422265	166	422309	168	422401	186	422473	170
422195	190	422266	166	422310	171	422402	186	422474	170
422196	190	422267	166	422311	171	422403	187	422475	170
422197	190	422268	166	422312	171	422404	187	422477	169
422198	190	422269	166	422313	171	422405	187	422478	170
422199	192	422270	166	422314	171	422406	187	422479	169
422200	192	422271	172	422317	158	422407	187	422480	170
422201	192	422272	172	422324	67	422408	187	422481	169
422202	192	422273	167	422325	67	422409	187	422482	169
422204	194	422274	167	422327	160	422410	187	422483	169
422205	193	422275	167	422328	160	422411	188	422484	169
422206	193	422276	167	422329	160	422412	188	422485	170
422207	194	422277	167	422345	188	422413	188	422486	170
422208	193	422278	167	422346	188	422414	188	422487	170
422209	194	422279	167	422347	188	422415	172	422488	170
422210	193	422280	167	422348	188	422416	172	422489	170
422211	193	422280-1000	167	422349	188	422417	172	422490	170
422212	194	422281	167	422350	188	422418	172	422491	170
422213	194	422281-1000	167	422351	188	422419	172	422492	168
422214	194	422282	167	422352	188	422420	172	422493	168
422215	169	422282-1000	167	422353	188	422421	179	422494	171
422216	169	422283	167	422354	188	422422	179	422495	171
422217	169	422283-1000	167	422355	188	422423	179	422496	171
422218	169	422284	167	422356	188	422424	179	422497	171
422219	169	422284-1000	167	422357	189	422425	179	422498	171
422220	169	422285	167	422358	189	422426	179	422499	168
422221	169	422285-1000	167	422359	189	422427	179	422500	168
422222	169	422286	167	422360	189	422428	179	422501	168
422223	169	422286-1000	167	422361	189	422429	179	422502	168
422224	169	422287	167	422362	189	422430	179	422503	166
422225	169	422287-1000	167	422363	178	422431	179	422504	184
422226	169	422288	167	422364	178	422432	179	422505	184
422227	169	422288-1000	167	422365	178	422433	179	422506	184
422228	169	422289	167	422366	178	422434	179	422507	184
422229	169	422289-1000	167	422367	178	422435	179	422508	184

# Index



Part Number	Page Number	Part Number	Page Number	Part Number	Page Number	Part Number	Page Number	Part Number	Page Number
422509	184	422576	179	422643	150	424303	121	431149	198
422510	188	422577	178	422645	150	424304	121	431150	198
422511	188	422578	180	422646	150	424305	121	431151	198
422512	188	422579	180	422647	150	424306	121	431152	198
422513	179	422580	180	422648	152	431002	197	431154	196
422514	179	422581	179	422649	152	431003	197	431402	65
422515	179	422583	180	422651	150	431005	197	431402-12	65
422516	179	422584	181	422652	153	431006	197	431402-100	65
422517	179	422585	181	422653	153	431008	197	431403	65
422518	179	422586	181	422655	157	431009	197	431403-12	65
422519	179	422587	181	422656	157	431010	197	431403-100	65
422520	179	422588	182	422657	157	431011	197	431405	65
422521	179	422589	182	422658	157	431012	197	431405D	65
422522	179	422590	182	422661	152	431013	197	431406	65
422523	179	422591	182	422662	152	431014	197	431408	65
422524	187	422592	183	422663	152	431015	197	431408-100	65
422525	187	422593	183	422664	152	431084	196	431410	65
422526	190	422594	183	422665	152	431085	196	431410-100	65
422527	190	422595	183	422666	152	431086	196	431702	197
422528	190	422596	183	422667	152	431087	196	431715	197
422529	190	422597	183	422668	152	431088	196	431717	197
422530	190	422598	183	422669	152	431089	196	431718	197
422531	190	422599	192	422671	152	431090	196	431731	197
422532	190	422600	192	422672	152	431091	196	431745	157
422533	190	422601	192	422673	153	431093	199	431746	157
422534	190	422602	192	422674	153	431094	199	431747	157
422535	179	422603	192	422675	153	431095	199	441000	77
422536	179	422604	192	422676	153	431096	199	441001	77
422537	179	422605	192	422677	153	431097	199	441003	77
422538	179	422606	192	422679	153	431098	199	441004	77
422539	179	422607	192	422680	153	431099	199	441005	77
422540	179	422608	192	422681	153	431100	199	441007	77
422541	180	422609	192	422682	153	431101	199	441008	77
422542	178	422610	192	422684	153	431102	199	441012	77
422543	180	422611	192	422685	151	431103	199	441014	77
422544	179	422612	192	422686	151	431104	199	441015	75
422545	179	422613	192	422687	151	431105	199	441016	75
422546	179	422614	192	422688	151	431106	199	441017	75
422547	179	422615	192	422690	151	431107	199	441018	78
422548	178	422616	192	422692	154	431108	199	441019	78
422549	180	422617	192	422693	154	431110	200	441022	78
422550	182	422618	192	422694	154	431111	200	441023	78
422551	182	422619	191	422695	154	431112	200	441047	79
422552	179	422620	191	422696	154	431113	200	441050	75
422553	179	422621	192	422697	154	431114	200	441051	75
422554	179	422622	192	422698	154	431115	200	441056	75
422555	179	422623	192	422699	155	431116	200	441057	75
422556	178	422624	192	422700	155	431117	200	441058	75
422557	180	422625	192	422701	155	431118	200	441059	75
422559	180	422626	192	422702	155	431119	200	441060	75
422560	180	422627	191	422703	155	431120	200	441062	78
422561	193	422628	192	422705	155	431121	200	441063	78
422562	180	422629	191	422707	155	431124	197	441064	78
422563	180	422630	191	422709	155	431130	200	441065	78
422564	178	422631	191	422710	155	431131	200	441066	78
422565	178	422632	192	422711	155	431132	200	441067	78
422567	180	422633	191	422712	155	431133	200	441068	78
422568	180	422634	160	422713	155	431134	199	441069	78
422569	182	422635	160	422714	155	431135	199	441070	78
422570	182	422636	172	422720	180	431136	199	441071	77
422571	179	422637	172	422721	180	431137	199	441072	77
422572	179	422638	172	422722	180	431145	198	441074	78
422573	179	422639	191	424176	120	431146	198	441075	78
422574	180	422640	191	424177	120	431147	198	441078	76
422575	179	422642	153	424302	121	431148	198	441079	76



Part Number	Page Number	Part Number	Page Number	Part Number	Page Number	Part Number	Page Number	Part Number	Page Number
441080	77	441731	80	451033B	62	451061NB	54	451130	57
441081	77	441736	79	451033B-250	62	451061NR	54	451131	57
441083	78	441737	79	451033G	62	451062	63	451139	57
441085	78	441738	79	451033G-250	62	451063	63	451140	57
441088	76	441739	79	451033NG	62	451064N	54	451141	57
441089	76	441747	80	451033NG-250	62	451064NB	54	451149	57
441090	76	441748	80	451033R	62	451064NR	54	451150	57
441091	76	441749	79	451033R-250	62	451066	55	451151	57
441092	76	441750	80	451033Y	62	451067	62	451159	57
441093	76	441751	81	451033Y-250	62	451067-1000	62	451160	57
441094	76	441752-01	80	451034	62	451068	62	451161	57
441095	79	441752-03	80	451034-250	62	451068-1000	62	451169	70
441095D	79	441766	80	451035	54	451069	68	451170	70
441095P	79	441799	81	451035B	54	451087	68	451178	70
441098	78	441818	76	451035N	54	451088	69	451180	56
441099	78	441819	76	451035NB	54	451089	58	451181	56
441102	78	441820	76	451035NP	55	451089N	55	451182	56
441103	78	441821	76	451035NR	54	451089NB	55	451183	56
441104	78	441822	79	451035R	54	451089NR	55	451184	56
441105	78	441823	79	451036	54	451090N	55	451185	56
441106	78	451000	69	451036B	54	451090NB	55	451186	56
441129	81	451001	69	451036N	54	451090NR	55	451187	56
441130	81	451009	69	451036NB	54	451091N	55	451188	56
441131	76	451027	63	451036NP	55	451091NB	55	451189	56
441132	76	451028	63	451036NR	54	451091NR	55	451190	56
441133	76	451029	62	451036R	54	451092N	54	451191	56
441134	80	451029-2000	62	451037	69	451092NB	54	451192	56
441145	75	451030	62	451038	69	451092NR	54	451193	56
441148	76	451030-1000	62	451039	54	451093N	54	451194	56
441149	76	451030B	62	451039B	54	451093NB	54	451706	68
441150	78	451030B-1000	62	451039N	54	451093NR	54	451707	68
441151	78	451030G	62	451039NB	54	451094	68	451708	68
441152	78	451030G-1000	62	451039NP	55	451095	68	451711	68
441153	78	451030NG	62	451039NR	54	451096	58	451712	68
441154	78	451030NG-1000	62	451039R	54	451097	56	451713	68
441155	78	451030R	62	451040N	55	451098	56	451716	68
441161	76	451030R-1000	62	451040NB	55	451099	56	451717	68
441161L	76	451030Y	62	451040NR	55	451100	69	451718	68
441162	76	451030Y-1000	62	451041N	55	451101	80	451719	68
441162L	76	451031	62	451041NB	55	451102	80	451720	68
441164	76	451031-500	62	451041NR	55	451103	80	451721	68
441164L	76	451031B	62	451042N	55	451104	80	451722	68
441165	76	451031B-500	62	451042NB	55	451105	80	451723	68
441165L	76	451031G	62	451042NR	55	451106	58	451724	68
441167	79	451031G-500	62	451044	63	451107	56	451725	68
441168	79	451031NG	62	451045	63	451108	56	451726	68
441169	77	451031NG-500	62	451046	68	451111	56	451727	68
441170	77	451031R	62	451047	68	451112	56	451728	68
441171	77	451031R-500	62	451048	68	451113	56	451729	68
441172	77	451031Y	62	451049	68	451114	56	451730	68
441205	77	451031Y-500	62	451050	68	451116	58	451732	68
441206	77	451032	62	451051	68	451117	58	451733	68
441207	77	451032-500	62	451052	68	451118	58	451734	68
441208	77	451032B	62	451053	68	451119	56	451735	68
441222	74	451032B-500	62	451054	62	451120	56	451736	68
441223	74	451032G	62	451054-500	62	451121	56	451737	68
441224	77	451032G-500	62	451055	54	451122	57	451738	68
441225	77	451032NG	62	451056N	54	451123	57	451739	68
441226	74	451032NG-500	62	451056NB	54	451124	57	451740	68
441227	74	451032R	62	451056NR	54	451125	57	451741	68
441228	74	451032R-500	62	451057	67	451126	66	451742	68
441229	74	451032Y	62	451058	67	451126D	66	451743	68
441233	75	451032Y-500	62	451059	67	451127	66	451744	68
441704	80	451033	62	451060	67	451128	66	451745	68
441721	79	451033-250	62	451061N	54	451129	57	451746	68

# Index



Part Number	Page Number	Part Number	Page Number	Part Number	Page Number	Part Number	Page Number	Part Number	Page Number
451747	68	452212MAX	46	452324	47	453134MAX	46	453244	47
451748	68	452214	47	452324MAX	46	453136	47	453244MAX	46
451749	68	452214MAX	46	452326	47	453136MAX	46	453246	47
452000	52	452216	47	452326MAX	46	453138	47	453246MAX	46
452001	52	452216MAX	46	452328	47	453138MAX	46	453248	47
452002	52	452218	47	452328MAX	46	453140	47	453248MAX	46
452108	47	452218MAX	46	452330	47	453140MAX	46	453250	47
452108MAX	46	452220	47	452330MAX	46	453142	47	453250MAX	46
452112	47	452220MAX	46	452332	47	453142MAX	46	453252	47
452112MAX	46	452222	47	452332MAX	46	453144	47	453252MAX	46
452114	47	452222MAX	46	452334	47	453144MAX	46	453254	47
452114MAX	46	452224	47	452334MAX	46	453146	47	453254MAX	46
452116	47	452224MAX	46	452336	47	453146MAX	46	453256	47
452116MAX	46	452226	47	452336MAX	46	453148	47	453256MAX	46
452118	47	452226MAX	46	452338	47	453148MAX	46	453260	47
452118MAX	46	452228	47	452338MAX	46	453150	47	453260MAX	46
452120	47	452228MAX	46	452340	47	453150MAX	46	453266	47
452120MAX	46	452230	47	452340MAX	46	453152	47	453266MAX	46
452122	47	452230MAX	46	452342	47	453152MAX	46	453272	47
452122MAX	46	452232	47	452342MAX	46	453154	47	453272MAX	46
452124	47	452232MAX	46	452344	47	453154MAX	46	453284	47
452124MAX	46	452234	47	452344MAX	46	453156	47	453284MAX	46
452126	47	452234MAX	46	452346	47	453156MAX	46	453308	47
452126MAX	46	452236	47	452346MAX	46	453160	47	453308MAX	46
452128	47	452236MAX	46	452348	47	453160MAX	46	453312	47
452128MAX	46	452238	47	452348MAX	46	453166	47	453312MAX	46
452130	47	452238MAX	46	452350	47	453166MAX	46	453314	47
452130MAX	46	452240	47	452350MAX	46	453172	47	453314MAX	46
452132	47	452240MAX	46	452352	47	453172MAX	46	453316	47
452132MAX	46	452242	47	452352MAX	46	453184	47	453316MAX	46
452134	47	452242MAX	46	452356	47	453184MAX	46	453318	47
452134MAX	46	452244	47	452356MAX	46	453208	47	453318MAX	46
452136	47	452244MAX	46	452360	47	453208MAX	46	453320	47
452136MAX	46	452246	47	452360MAX	46	453212	47	453320MAX	46
452138	47	452246MAX	46	452366	47	453212MAX	46	453322	47
452138MAX	46	452248	47	452366MAX	46	453214	47	453322MAX	46
452140	47	452248MAX	46	452372	47	453214MAX	46	453324	47
452140MAX	46	452250	47	452372MAX	46	453216	47	453324MAX	46
452142	47	452250MAX	46	452384	47	453216MAX	46	453326	47
452142MAX	46	452252	47	452384MAX	46	453218	47	453326MAX	46
452144	47	452252MAX	46	453108	47	453218MAX	46	453328	47
452144MAX	46	452256	47	453108MAX	46	453220	47	453328MAX	46
452146	47	452256MAX	46	453112	47	453220MAX	46	453330	47
452146MAX	46	452260	47	453112MAX	46	453222	47	453330MAX	46
452148	47	452260MAX	46	453114	47	453222MAX	46	453332	47
452148MAX	46	452266	47	453114MAX	46	453224	47	453332MAX	46
452150	47	452266MAX	46	453116	47	453224MAX	46	453334	47
452150MAX	46	452272	47	453116MAX	46	453226	47	453334MAX	46
452152	47	452272MAX	46	453118	47	453226MAX	46	453336	47
452152MAX	46	452284	47	453118MAX	46	453228	47	453336MAX	46
452154	47	452284MAX	46	453120	47	453228MAX	46	453338	47
452154MAX	46	452308	47	453120MAX	46	453230	47	453338MAX	46
452156	47	452308MAX	46	453122	47	453230MAX	46	453340	47
452156MAX	46	452312	47	453122MAX	46	453232	47	453340MAX	46
452160	47	452312MAX	46	453124	47	453232MAX	46	453342	47
452160MAX	46	452314	47	453124MAX	46	453234	47	453342MAX	46
452166	47	452314MAX	46	453126	47	453234MAX	46	453344	47
452166MAX	46	452316	47	453126MAX	46	453236	47	453344MAX	46
452172	47	452316MAX	46	453128	47	453236MAX	46	453346	47
452172MAX	46	452318	47	453128MAX	46	453238	47	453346MAX	46
452184	47	452318MAX	46	453130	47	453238MAX	46	453348	47
452184MAX	46	452320	47	453130MAX	46	453240	47	453348MAX	46
452208	47	452320MAX	46	453132	47	453240MAX	46	453350	47
452208MAX	46	452322	47	453132MAX	46	453242	47	453350MAX	46
452212	47	452322MAX	46	453134	47	453242MAX	46	453352	47

Part Number	Page Number	Part Number	Page Number	Part Number	Page Number	Part Number	Page Number	Part Number	Page Number
453352MAX	46	455084	49	456026	49	460048	49	462036	64
453356	47	455129AB	58	456028	49	460052	49	462048	64
453356MAX	46	455129AR	58	456030	49	460072	49	462124	64
453360	47	455132B	58	456032	49	460084	49	462136	64
453360MAX	46	455132R	58	456034	49	460096	49	462218	64
453366	47	455144	59	456036	49	460108	49	462224	64
453366MAX	46	455144AB	59	456038	49	460120	49	462230	64
453372	47	455144AR	59	456040	49	460144	49	462236	64
453372MAX	46	455144ASET	61	456042	49	461001	84	462252	64
453384	47	455144B	59	456044	49	461002	84	462254	64
453384MAX	46	455144BMAXX	59	456046	49	461003	84	462272	64
454008	49	455144DSET	61	456048	49	461004	84	462284	64
454012	49	455144MAXXSET	61	456050	49	461005	84	462318	64
454014	49	455144PBMAXX	59	456052	49	461006	83	462324	64
454016	49	455144PMAXXSET	61	456056	49	461007	83	490000	69
454018	49	455144PRMAXX	59	456060	49	461008	86	490001	69
454020	49	455144R	59	456066	49	461009	86	490002	69
454022	49	455144RMAXX	59	456072	49	461011	86	490003	69
454024	49	455144SET	61	456084	49	461012	84	490004	69
454026	49	455165AB	58	457060	48	461018	84	490005	69
454027	49	455165AR	58	457066	48	461019	84	490404	71
454028	49	455168	58	457072	48	461020	83	490406	71
454030	49	455168B	58	457078	48	461022	86	491006	71
454032	49	455168R	58	457084	48	461023	83	491008	71
454034	49	455180	59	457090	48	461024	86	491010	71
454036	49	455180AB	59	457096	48	461025	85	491012	71
454038	49	455180AR	59	457102	48	461026	83	491016	71
454040	49	455180ASET	61	457108	48	461027	83	491020	71
454042	49	455180B	59	457114	48	461029	85	491024	71
454044	49	455180BMAXX	59	457120	48	461032	85	491028	71
454046	49	455180DSET	61	457126	48	461033	85	491032	71
454048	49	455180MAXXSET	61	457132	48	461034	85	491036	71
454050	49	455180PBMAXX	59	457135	48	461035	86	491040	71
454052	49	455180PMAXXSET	61	457138	48	461036	86	491044	71
454056	49	455180PRMAXX	59	457144	48	461037	85	491048	71
454060	49	455180R	59	458060	48	461039	86	491052	71
454066	49	455180RMAXX	59	458066	48	461040	85	491056	71
454072	49	455180SET	61	458072	48	461112	48	491060	71
454084	49	455225AB	58	458078	48	461115	48	491064	71
455008	49	455225AR	58	458084	48	461116	48	491072	71
455012	49	455228	58	458090	48	461117	48	491080	71
455014	49	455228B	58	458096	48	461118	48	491088	71
455016	49	455228R	58	458102	48	461120	48	491096	71
455018	49	455240	59	458108	48	461124	48	491104	71
455020	49	455240AB	59	458114	48	461126	48	491206	71
455022	49	455240AR	59	458120	48	461127	48	491208	71
455024	49	455240ASET	61	458126	48	461128	48	491210	71
455026	49	455240B	59	458132	48	461129	48	491212	71
455028	49	455240BMAXX	59	458138	48	461130	48	491216	71
455030	49	455240DSET	61	458144	48	461132	48	491220	71
455032	49	455240MAXXSET	61	459060	48	461134	48	491224	71
455034	49	455240PBMAXX	59	459066	48	461136	48	491228	71
455036	49	455240PMAXXSET	61	459072	48	461209	146	491232	71
455038	49	455240PRMAXX	59	459078	48	461212	146	491236	71
455040	49	455240R	59	459084	48	461216	146	491240	71
455042	49	455240RMAXX	59	459090	48	461220	146	491244	71
455044	49	455240SET	61	459096	48	461224	146	491248	71
455046	49	456008	49	459102	48	461230	146	491300	72
455048	49	456012	49	459108	48	461236	146	491310	72
455050	49	456014	49	459114	48	462000	63	491312	72
455052	49	456016	49	459120	48	462001	63	491316	72
455056	49	456018	49	459126	48	462002	63	491320	72
455060	49	456020	49	459132	48	462018	64	491324	72
455066	49	456022	49	459138	48	462024	64	491325	72
455072	49	456024	49	459144	48	462030	64	491330	72

# Index



Part Number	Page Number	Part Number	Page Number	Part Number	Page Number	Part Number	Page Number	Part Number	Page Number
491335	72	491817	202	500402	174	563366-48	51	<b>B</b>	
491340	72	492000	73	500403	174	563366-50	51		
491345	72	492001	73	500500	174	563366-52	51	B362RB-6	95
491350	72	492002	73	500501	174	563366-54	51	B362RB-8	95
491355	72	492003	73	500502	174	563366-56	51	B366RBSV-634	95
491360	72	492004	73	500503	174	563366-60	51	B366RBSV-878	95
491450	72	492005	73	500600	174	563366-66	51	B455144	60
491451	72	492006	73	500601	174	563366-72	51	B455144AB	60
491452	72	492007	73	500602	174	563366-84	51	B455144B	60
491453	72	492008	73	500603	174	666600-18	50	B455144BMAXX	60
491454	72	492009	73	500700	174	666600-24	50	B455144PBMAXX	60
491455	72	492100	73	500701	174	666600-30	50	B455180	60
491456	72	492101	73	500702	174	666600-36	50	B455180AB	60
491457	72	492102	73	500703	174	666600-42	50	B455180B	60
491458	72	492103	73	500800	175	666600-48	50	B455180BMAXX	60
491459	72	492104	73	500801	176	666600-54	50	B455180PBMAXX	60
491460	72	492105	73	500802	176	666600-60	50	B455240	60
491461	72	492106	73	500803	176	688800-18	50	B455240AB	60
491462	72	492107	73	562366-08	51	688800-22	50	B455240B	60
491503	72	492108	73	562366-12	51	688800-24	50	B455240BMAXX	60
491504	72	492109	73	562366-14	51	688800-30	50	B455240PBMAXX	60
491505	72	492110	73	562366-16	51	688800-36	50	BR455144ASET	61
491506	72	492111	73	562366-18	51	688800-42	50	BR455144DSET	61
491620	73	492112	73	562366-20	51	688800-48	50	BR455144MAXXSET	61
491621	73	492113	73	562366-22	51	688800-55	50	BR455144PMAXXSET	61
491622	73	492200	171	562366-24	51	688800-60	50	BR455144SET	61
491623	73	492201	171	562366-26	51	3160001	5	BR455180ASET	61
491624	73	492202	171	562366-28	51	3180001	5	BR455180DSET	61
491625	73	500001	176	562366-30	51	3410009	16	BR455180MAXXSET	61
491626	73	500002	176	562366-32	51	3420051	15	BR455180PMAXXSET	61
491627	73	500003	176	562366-34	51	3420087	15	BR455180SET	61
491628	73	500004	177	562366-36	51	3420097	16	BR455240ASET	61
491700	71	500005	177	562366-38	51	3600024	21	BR455240DSET	61
491701	71	500006	177	562366-40	51	3638005	20	BR455240MAXXSET	61
491708	71	500007	177	562366-42	51	3638006	20	BR455240PMAXXSET	61
491712	71	500008	177	562366-44	51	3820009	39	BR455240SET	61
491716	71	500009	176	562366-46	51	3820017	39		
491720	71	500010	176	562366-48	51	3822010	40	<b>C</b>	
491724	71	500011	177	562366-50	51	3822011	40		
491728	71	500012	177	562366-52	51	3822012	40	C8016	22
491736	71	500013	177	562366-54	51	3822013	40		
491740	71	500014	177	562366-56	51	3826004	39	<b>G</b>	
491744	71	500015	177	562366-60	51	3826015	39		
491748	71	500016	177	562366-66	51	3826020	39	GH1004	76
491752	71	500017	175	562366-72	51	3826021	39	GH1014	76
491760	71	500130	175	562366-84	51	3826022-1	32	GH5500	79
491772	71	500140	175	563366-08	51	3826035	32	GH6600	79
491780	71	500150	175	563366-12	51	3826035B	32	GH7700	79
491800	202	500160	175	563366-14	51	3826040	32		
491801	202	500200	175	563366-16	51	3826045	39	<b>H</b>	
491802	202	500201	175	563366-18	51	3827005	39		
491803	202	500202	175	563366-20	51	3829002	39	H340-4095	234
491804	202	500203	175	563366-22	51	3849709	40	H4020	234
491805	202	500204	175	563366-24	51	3850008	33	H4042	234
491806	202	500205	175	563366-26	51	3850015	33	H4249	234
491807	202	500206	175	563366-28	51	3850029	39	H74009	234
491808	202	500207	175	563366-30	51	3850031	33	H74024	234
491809	202	500300	175	563366-32	51	3850032	33	H74075	234
491810	202	500301	175	563366-34	51	3850041	33	H74195	234
491811	202	500302	175	563366-36	51	3850042	33	H84009H	234
491812	202	500303	175	563366-38	51	3850200	39	H84024	234
491813	202	500304	174	563366-40	51	3870102	40	H84075	234
491814	202	500305	174	563366-42	51	4917104	71	H84195	234
491815	202	500400	174	563366-44	51			HPHN-8-8	105
491816	202	500401	174	563366-46	51			HPHN-12-8	105

Part Number	Page Number	Part Number	Page Number	Part Number	Page Number	Part Number	Page Number	Part Number	Page Number	
HPHN-12-12	105	KV2K15-37S	10	KV2Y07-34S	10	S39-8	111	S44-8	111	
<b>K</b>		KV2K19-36S	10	KV2Y07-35S	10	S39-10	111	S44-8-6-6	111	
		KV2K19-37S	10	KV2Y07-36S	10	S40-3	111	S44-8-6-8	111	
		KV2L03-00	12	KV2Y11-35S	10	S40-4	111	S44-8-8-6	111	
KV2E03-00	12	KV2L03-34S	10	KV2Y11-36S	10	S40-5	111	S44-10	111	
KV2E03-35	12	KV2L07-00	12	KV2Y11-37S	10	S40-6	111	S44-10-6-6	111	
KV2E07-00	12	KV2L07-34S	10	KV2Y13-35S	10	S40-8	111	S44-10-10-8	111	
KV2E07-34	12	KV2L07-35S	10	KV2Y13-36S	10	S40-10	111	S45-6-2	111	
KV2E07-35	12	KV2L07-36S	10	KV2Y13-37S	10	S41IF-3	110	S46-3-2	112	
KV2E11-00	12	KV2L11-00	12	<b>L</b>		S41IF-4	110	S46-4-2	112	
KV2E11-35	12	KV2L11-34S	10		S41IF-5	110	S46-4-4	112		
KV2E11-36	12	KV2L11-35S	10		S41IF-6	110	S46-4-6	112		
KV2E13-00	12	KV2L11-36S	10		S41IF-8	110	S46-4-8	112		
KV2E13-36	12	KV2L11-37S	10		LL7820-54	48	S41IFS-2	110	S46-5-2	112
KV2E13-37	12	KV2L13-00	12		LL7820-60	48	S41IFS-3	110	S46-5-4	112
KV2E15-00	12	KV2L13-35S	10		LL7820-72	48	S41IFS-4	110	S46-6-2	112
KV2F03-34	11	KV2L13-36S	10		LL7820-84	48	S41IFS-5	110	S46-6-4	112
KV2F03-35	11	KV2L13-37S	10		LL7820-90	48	S41IFS-6	110	S46-6-6	112
KV2F07-34	11	KV2L15-36S	10		LL7820-108	48	S41IFS-8	110	S46-6-8	112
KV2F07-35	11	KV2L15-37S	10	LL7820-114	48	S41IFS-10	110	S46-6-12	112	
KV2F07-36	11	KV2L19-37S	10	LL7820-S54	48	S41IFS-12	110	S46-8-4	112	
KV2F11-34	11	KV2LF03-34	11	LL7820-S60	48	S41L-4	111	S46-8-6	112	
KV2F11-35	11	KV2LF03-35	11	LL7820-S72	48	S41L-5	111	S46-8-8	112	
KV2F11-36	11	KV2LF07-34	11	LL7820-S84	48	S41L-6	111	S46-8-12	112	
KV2F11-37	11	KV2LF07-35	11	LL7820-S96	48	S41L-8	111	S46-10-6	112	
KV2F13-34	11	KV2LF07-36	11	LL7820-S106	48	S41L-10	111	S46-10-8	112	
KV2F13-35	11	KV2LF11-34	11	LL7820-S108	48	S41S-2	111	S46-10-12	112	
KV2F13-36	11	KV2LF11-35	11	LL7820-S114	48	S41S-3	111	S46-12-12	112	
KV2F13-37	11	KV2LF11-36	11	LL7820-S132	48	S41S-4	111	S46-14-12	112	
KV2H03-00	12	KV2LF11-37	11	LL7820-S138	48	S41S-5	111	S46FS-6-6	112	
KV2H03-07	12	KV2LF13-35	11	LL7820-S150	48	S41S-6	111	S46FS-8-8	112	
KV2H03-33S	9	KV2LF13-36	11	LL7820-S168	48	S41S-6-4	111	S46FS-10-10	112	
KV2H03-34S	9	KV2LF13-37	11	<b>M</b>		S41S-7	111	S46IF-3-2	110	
KV2H03-35S	9	KV2P-03	12		MF110343	235	S41S-8	111	S46IF-4-2	110
KV2H07-00	12	KV2P-07	12		MF110343	235	S41S-8-6	111	S46IF-5-2	110
KV2H07-11	12	KV2P-11	12		MF111010	235	S41S-10	111	S46IF-6-4	110
KV2H07-34S	9	KV2P-13	12		MF111026	235	S41S-12	111	S46IF-8-6	110
KV2H07-35S	9	KV2T03-00	12		MF111051	235	S41S-14	111	S48-2-2	112
KV2H07-36S	9	KV2T03-33S	11		MF111062	235	S42-2	111	S48-3-2	112
KV2H11-00	12	KV2T03-34S	11		MF111077	235	S42-3	111	S48-3-4	112
KV2H11-34S	9	KV2T03-35S	11		MF111099	235	S42-4	111	S48-4-2	112
KV2H11-35S	9	KV2T07-00	12		<b>R</b>		S42-5	111	S48-4-4	112
KV2H11-36S	9	KV2T07-34S	11	R455144		60	S42-6	111	S48-4-6	112
KV2H11-37S	9	KV2T07-35S	11	R455144AR		60	S42-6-4	111	S48-4-8	112
KV2H13-00	12	KV2T07-36S	11	R455144AR		60	S42-6-5	111	S48-5-2	112
KV2H13-35S	9	KV2T11-00	12	R455144PRMAXX		60	S42-8	111	S48-5-4	112
KV2H13-36S	9	KV2T11-34S	11	R455144R		60	S42-8-4	111	S48-5-6	112
KV2H13-37S	9	KV2T11-35S	11	R455144R		60	S42-8-6	111	S48-6-2	112
KV2H15-00	12	KV2T11-36S	11	R455144RMAXX		60	S42-10	111	S48-6-4	112
KV2H15-36S	9	KV2T11-37S	11	R455180		60	S42-10-6	111	S48-6-6	112
KV2H15-37S	9	KV2T13-00	12	R455180AR		60	S42-10-8	111	S48-6-8	112
KV2H19-36S	9	KV2T13-35S	11	R455180AR	60	S42-12	111	S48-6-12	112	
KV2H19-37S	9	KV2T13-36S	11	R455180PRMAXX	60	S42-12-8	111	S48-8-4	112	
KV2K03-34S	10	KV2T13-37S	11	R455180R	60	S42-12	111	S48-8-6	112	
KV2K07-34S	10	KV2T15-00	12	R455180RMAXX	60	S42-14	111	S48-8-8	112	
KV2K07-35S	10	KV2T15-36S	11	R455240	60	S42IF-2	110	S48-8-8	112	
KV2K07-36S	10	KV2T15-37S	11	R455240AR	60	S42IF-3	110	S48-8-12	112	
KV2K11-34S	10	KV2TF07-34	11	R455240PRMAXX	60	S42IF-4	110	S48-10-4	112	
KV2K11-35S	10	KV2TF07-35	11	R455240R	60	S42IF-5	110	S48-10-6	112	
KV2K11-36S	10	KV2TF11-35	11	R455240RMAXX	60	S42IF-6	110	S48-10-8	112	
KV2K11-37S	10	KV2TF13-36	11	<b>S</b>		S42IF-8	110	S48-10-12	112	
KV2K13-35S	10	KV2TF15-35	11		S44-3	111	S44-3	111	S48-12-8	112
KV2K13-36S	10	KV2Y03-33S	10		S44-4	111	S44-4	111	S48-12-12	112
KV2K13-37S	10	KV2Y03-34S	10		S44-5	111	S44-5	111	S48-14-12	112
KV2K15-36S	10	KV2Y03-35S	10		S44-6	111	S44-6	111	S48IF-2-2	110
					S39-4	111	S44-6-6-8	111	S48IF-3-2	110
					S39-5	111				
					S39-6	111				

# Index



Part Number	Page Number	Part Number	Page Number	Part Number	Page Number	Part Number	Page Number	Part Number	Page Number
S48IF-4-2	110	S60TF-3	102	S64-8	100	S68-14-12	101	S71-8-8	101
S48IF-4-4	110	S60TF-5/32	102	S64-8-8-6	100	S68PMT-4-2	92	S71-10-8	101
S48IF-5-2	110	S61-2	99	S64-10	100	S68PMT-4-4	92	S72-2-2	101
S48IF-5-4	110	S61-3	99	S65-2	100	S68PMT-4-6	92	S72-3-2	101
S48IF-6-2	110	S61-4	99	S65-3	100	S68PMT-6-2	92	S72-4-2	101
S48IF-6-4	110	S61-5	99	S65-4	100	S68PMT-6-4	92	S72-4-4	101
S48IF-6-6	110	S61-6	99	S65-5	100	S68PMT-6-6	92	S72-5-2	101
S48IF-8-4	110	S61-7	99	S65-6	100	S68PMT-6-8	92	S72-5-4	101
S48IF-8-6	110	S61-8	99	S65-7	100	S68PMT-8-4	92	S72-6-2	101
S48IF-8-8	110	S61-10	99	S65-8	100	S68PMT-8-6	92	S72-6-4	101
S48IF-10-8	110	S61-12	99	S65-10	100	S68PMT-8-8	92	S72-6-6	101
S49-3-2	112	S61-14	99	S65-12	100	S68TF-2-1	102	S72-8-6	101
S49-4-2	112	S61CP-4	99	S66-2-2	100	S68TF-2-2	102	S72-8-8	101
S49-4-4	112	S61CP-6	99	S66-3-2	100	S68TF-3-2	102	S72-10-8	101
S49-4-6	112	S61CP-8	99	S66-3-4	100	S68TF-5/32-1	102	S73-3	106
S49-5-2	112	S61CP-10	99	S66-4-2	100	S68TF-5/32-2	102	S73-4	106
S49-5-4	112	S61L-2	99	S66-4-4	100	S69-2-2	101	S73-5	106
S49-6-2	112	S61L-4	99	S66-4-6	100	S69-3-2	101	S73-6	106
S49-6-4	112	S61L-5	99	S66-4-8	100	S69-3-4	101	S73-8	106
S49-6-6	112	S61L-6	99	S66-5-2	100	S69-4-2	101	S100	120
S49-6-8	112	S61L-8	99	S66-5-4	100	S69-4-4	101	S101	120
S49-8-4	112	S61L-10	99	S66-5-6	100	S69-4-6	101	S102-2	103
S49-8-6	112	S61L-12	99	S66-6-2	100	S69-5-2	101	S102-4	103
S49-8-8	112	S61TF-2	102	S66-6-4	100	S69-5-4	101	S102-6	103
S49-10-8	112	S61TF-3	102	S66-6-6	100	S69-5-6	101	S102-8	103
S50-6-6	112	S61TF-5/32	102	S66-6-8	100	S69-5-8	101	S104-4	103
S50-6-8	112	S62-2	99	S66-8-4	100	S69-6-2	101	S104-6	103
S50-8-8	112	S62-3	99	S66-8-6	100	S69-6-4	101	S104-8	103
S50-10-8	112	S62-4	99	S66-8-8	100	S69-6-6	101	S113-02-1.5-R	103
S50-10-12	112	S62-4-2	99	S66-10-6	100	S69-6-8	101	S113-02-2.5-R	103
S51-10B	63	S62-4-3	99	S66-10-8	100	S69-6-12	101	S113-02-2-R	103
S51-12B	63	S62-5	99	S66-10-12	100	S69-7-4	101	S113-02-3-R	103
S52-10	63	S62-5-4	99	S66-12-8	100	S69-7-6	101	S113-04-1.5-R	103
S52-10C	63	S62-6	99	S66-14-12	100	S69-8-4	101	S113-04-2.5-R	103
S52-12	63	S62-6-4	99	S66PMT-4-2	92	S69-8-6	101	S113-04-2-R	103
S52-12C	63	S62-6-5	99	S66PMT-4-4	92	S69-8-8	101	S113-04-3-R	103
S53-8-10	63	S62-7	99	S66PMT-6-4	92	S69-10-6	101	S113-06-1.5-R	103
S54-10-10	63	S62-8	99	S66PMT-6-6	92	S69-10-8	101	S113-06-2.5-R	103
S54-12-12	63	S62-8-6	99	S68-2-2	100	S69-10-12	101	S113-06-2-R	103
S55-3	113	S62-10	99	S68-3-2	100	S69TF-2-2	102	S113-06-3-R	103
S55-4	113	S62-10-6	99	S68-3-4	100	S69TF-5/32-2	102	S113-08-2.5-R	103
S55-6	113	S62-10-8	99	S68-4-2	100	S70-2-2	101	S113-08-3-R	103
S55-8	113	S62-12	99	S68-4-4	100	S70-3-2	101	S113-12-2-R	103
S55-10	113	S62-14	99	S68-4-6	100	S70-4-2	101	S114FSV-4	113
S56-10-10	63	S62PMT-4	92	S68-4-8	100	S70-4-4	101	S114FSV-5	113
S56-12-12	63	S62PMT-6	92	S68-5-2	100	S70-5-2	101	S114FSV-6	113
S57-8-10	63	S62PMT-8	92	S68-5-4	100	S70-5-4	101	S114FSV-8	113
S57-10-10	63	S62PMT-10	92	S68-5-6	100	S70-6-2	101	S114FSV-10	113
S57-12-12	63	S62PMT-12	92	S68-6-2	100	S70-6-4	101	S119-4-2	103
S60-2	99	S62PMTBH-4	92	S68-6-4	100	S70-6-6	101	S119-6-2	103
S60-3	99	S62PMTBH-6	92	S68-6-6	100	S70-6-8	101	S119-6-4	103
S60-4	99	S62PMTBH-8	92	S68-6-8	101	S70-8-4	101	S119-8-2	103
S60-5	99	S62TF-2	102	S68-6-12	101	S70-8-6	101	S119-8-4	103
S60-6	99	S62TF-5/32	102	S68-7-4	101	S70-8-8	101	S119-8-6	103
S60-7	99	S63PT-4	100	S68-7-6	101	S70-10-8	101	S120-2	103
S60-8	99	S63PT-5	100	S68-8-4	101	S71-2-2	101	S120-4	103
S60-10	99	S63PT-6	100	S68-8-6	101	S71-3-2	101	S120-4-2	103
S60-12	99	S63PT-8	100	S68-8-8	101	S71-4-2	101	S120-6	103
S60-14	99	S63PT-10	100	S68-8-12	101	S71-4-4	101	S120-6-2	103
S60PT-4	99	S64-2	100	S68-10-6	101	S71-5-2	101	S120-6-4	103
S60PT-5	99	S64-3	100	S68-10-8	101	S71-5-4	101	S120-8	103
S60PT-6	99	S64-4	100	S68-10-12	101	S71-6-2	101	S120-8-4	103
S60PT-8	99	S64-5	100	S68-12-8	101	S71-6-4	101	S120-8-6	103
S60PT-10	99	S64-6	100	S68-12-12	101	S71-6-6	101	S120-12-8	103
S60TF-2	102	S64-6-6-4	100	S68-14-8	101	S71-8-6	101	S125-2-2	106

Part Number	Page Number	Part Number	Page Number	Part Number	Page Number	Part Number	Page Number	Part Number	Page Number
S125-2-4	106	S129-10-8	107	S145-12-8	114	S155-6	115	S226-6	104
S125-3-2	106	S136-6-6	113	S145-12-12	114	S155-8	115	S226-8	104
S125-3-4	106	S136-6-8	113	S146-4-4	107	S155-8-6	115	S226-12	104
S125-4-2	106	S136-8-8	113	S146-4-6	107	S155-10	115	S244IF-3	110
S125-4-4	106	S139-4-2	107	S146-6-6	107	S155-10-6	115	S244IF-4	110
S125-4-6	106	S139-5-2	107	S146-6-8	107	S155-10-8	115	S244IF-5	110
S125-4-8	106	S139-5-4	107	S146-8-8	107	S155-14	115	S244IF-6	110
S125-5-2	106	S139-6-2	107	S149-2-2	114	S159-4-2	115	S244IF-8	110
S125-5-4	106	S139-6-4	107	S149-3-2	114	S159-4-4	115	S245IF-3-2	110
S125-5-6	106	S139-6-6	107	S149-4-2	114	S159-6-4	115	S245IF-4-2	110
S125-6-2	106	S139-8-4	107	S149-4-4	114	S159-6-6	115	S245IF-5-2	110
S125-6-4	106	S139-8-6	107	S149-4-6	114	S159-8-6	115	S245IF-6-4	110
S125-6-6	106	S139-10-6	107	S149-4-8	114	S159-10-8	115	S249IF-2-2	110
S125-6-8	106	S141L-4	113	S149-5-2	114	S200-2	103	S249IF-3-2	110
S125-8-4	106	S141L-5	113	S149-5-4	114	S200-4	103	S249IF-4-2	110
S125-8-6	106	S141L-6	113	S149-5-6	114	S200-6	103	S249IF-4-4	110
S125-8-8	106	S141L-8	113	S149-5-8	114	S200-8	103	S249IF-5-2	110
S125-8-12	106	S141L-10	113	S149-6-2	114	S202-2	103	S249IF-5-4	110
S125-10-6	106	S141L-12	113	S149-6-4	114	S202-4	103	S249IF-6-2	110
S125-10-8	106	S141S-3	113	S149-6-6	114	S202-4-2	103	S249IF-6-4	110
S125-10-12	106	S141S-4	113	S149-6-8	114	S202-6	103	S249IF-6-6	110
S125-12-8	106	S141S-5	113	S149-8-4	114	S202-8	103	S249IF-8-4	110
S125-12-12	106	S141S-6	113	S149-8-6	114	S202-8-6	103	S249IF-8-6	110
S125-16-12	106	S141S-6-4	113	S149-8-8	114	S202-12	103	S249IF-8-8	110
S125-16-16	106	S141S-6-5	113	S149-8-12	114	S203-2	103	S249IF-10-6	110
S126-2-2	106	S141S-8	113	S149-10-4	114	S203-4	103	S249IF-10-8	110
S126-3-2	106	S141S-8-6	113	S149-10-6	114	S203-6	103	S254PMT-4-2	92
S126-4-2	106	S141S-10	113	S149-10-8	114	S203-8	103	S254PMT-4-4	92
S126-4-4	106	S141S10-8	113	S149-10-12	114	S207-2	104	S254PMT-4-6	92
S126-5-2	106	S141S-12	113	S149-12-8	114	S207-4	104	S254PMT-6-6	92
S126-5-4	106	S141S-14	113	S149-12-12	114	S207-6	104	S254PMT-8-6	92
S126-6-2	106	S144-2	113	S150-3-2	114	S207-8	104	S254PMT-8-8	92
S126-6-4	106	S144-3	113	S150-4-2	114	S207-12	104	S254PMT-12-8	92
S126-6-6	106	S144-4	113	S150-4-4	114	S211-2	104	S259IF-3-2	110
S126-6-8	106	S144-4-4-6	113	S150-4-6	114	S211-4	104	S259IF-4-2	110
S126-8-4	106	S144-5	113	S150-5-2	114	S211-6	104	S259IF-5-2	110
S126-8-6	106	S144-6	113	S150-5-4	114	S211-8	104	S259IF-5-4	110
S126-8-8	106	S144-6-6-4	113	S150-6-2	114	S211-12	104	S259IF-6-4	110
S126-12-12	106	S144-6-6-8	113	S150-6-4	114	S213-2	104	S260AB-4	116
S127-4-2	106	S144-6-10-10	113	S150-6-6	114	S213-4	104	S260AB-6	116
S127-4-4	106	S144-8	113	S150-6-8	114	S213-6	104	S260AB-8	116
S127-6-4	106	S144-8-6-6	113	S150-6-12	114	S213-8	104	S260AB-10	116
S127-6-6	106	S144-8-6-8	113	S150-8-4	114	S215-2	104	S260AB-12	116
S127-8-6	106	S144-8-8-4	113	S150-8-6	114	S215-4	104	S261AB-4	116
S127-8-8	106	S144-8-8-6	113	S150-8-8	114	S215-6	104	S261AB-6	116
S128-4-4	106	S144-8-8-10	113	S150-8-12	114	S215-8	104	S261AB-8	116
S128-5-4	106	S144-10	113	S150-10-6	114	S215-12	104	S261AB-10	116
S128-6-4	106	S144-10-6-6	113	S150-10-8	114	S219P-2	105	S261AB-12	116
S128-6-6	106	S144-10-8-6	113	S150-10-12	114	S219P-4	105	S262AB-4	116
S128-8-6	106	S144-10-8-10	113	S151-3-2	114	S219P-6	105	S262AB-6	116
S128-8-8	106	S144-10-10-6	113	S151-4-2	114	S219P-8	105	S262AB-8	116
S128-12-12	106	S144-10-10-8	113	S151-4-4	114	S219P-12	105	S262AB-10	116
S129-4-2	107	S144-12	113	S151-5-4	114	S220P-2	104	S262AB-12	116
S129-4-4	107	S144-14	113	S151-6-2	114	S220P-4	104	S264AB-6	116
S129-5-2	107	S145-3-2	114	S151-6-4	114	S220P-6	104	S264AB-8	116
S129-5-4	107	S145-4-2	114	S151-6-6	114	S224-2	104	S264PMT-4	92
S129-5-6	107	S145-4-4	114	S151-8-6	114	S224-4	104	S264PMT-6	92
S129-6-2	107	S145-5-2	114	S151-8-8	114	S224-6	104	S264PMT-8	92
S129-6-4	107	S145-5-4	114	S151-10-8	114	S224-8	104	S265AB-6	116
S129-6-6	107	S145-6-4	114	S152-4	114	S225-2	104	S265AB-8	116
S129-6-8	107	S145-6-6	114	S152-6	114	S225-4	104	S265PMT-4	92
S129-8-4	107	S145-6-8	114	S152-8	114	S225-6	104	S265PMT-6	92
S129-8-6	107	S145-8-6	114	S155-3	115	S225-8	104	S265PMT-8	92
S129-8-8	107	S145-8-8	114	S155-4	115	S226-2	104	S266AB-6-4	116
S129-10-6	107	S145-10-8	114	S155-5	115	S226-4	104	S266AB-6-6	116

# Index



Part Number	Page Number	Part Number	Page Number	Part Number	Page Number	Part Number	Page Number	Part Number	Page Number
S268AB-4-2	116	S272PMT-6-4	93	S625-6-6	108	S754PMT-6-6	94	S768AB-10-6	97
S268AB-4-4	116	S272PMT-6-6	93	S625-6-8	108	S760AB-4	97	S768AB-10-8	97
S268AB-4-6	116	S272PMT-8-4	93	S625-6-12	108	S760AB-6	97	S768AB-10-12	97
S268AB-6-2	116	S272PMT-8-6	93	S625-8-4	108	S760AB-8	97	S768AB-12-8	97
S268AB-6-4	116	S272PMT-8-8	93	S625-8-6	108	S760AB-10	97	S768AB-12-12	97
S268AB-6-6	116	S279AB-6-4	117	S625-8-8	108	S760AB-12	97	S768PMT-2-1	94
S268AB-6-8	116	S279AB-6-6	117	S625-8-12	108	S761AB-4	97	S768PMT-2-2	94
S268AB-8-4	116	S279AB-8-6	117	S625-10-6	108	S761AB-6	97	S768PMT-2-4	94
S268AB-8-6	116	S279AB-10-8	117	S625-10-8	108	S761AB-8	97	S768PMT-4-2	94
S268AB-8-8	116	S360AB-6	95	S625-10-12	108	S761AB-10	97	S768PMT-4-4	94
S268AB-10-6	116	S360AB-8	95	S625-12-8	108	S761AB-12	97	S768PMT-4-6	94
S268AB-10-8	116	S361AB-6	95	S625-12-12	108	S762AB-4	97	S768PMT-6-2	94
S268AB-12-8	116	S361AB-8	95	S629	118	S762AB-6	97	S768PMT-6-4	94
S268AB-12-12	116	S361ABS-6	95	S639PMT-4	93	S762AB-8	97	S768PMT-6-6	94
S269AB-4-2	116	S361ABS-8	95	S639PMT-6	93	S762AB-10	97	S768PMT-6-8	94
S269AB-4-4	116	S362RB-6	95	S639PMT-8	93	S762AB-12	97	S768PMT-8-4	94
S269AB-4-6	116	S362RB-8	95	S646	118	S762PMT-2	94	S768PMT-8-6	94
S269AB-6-2	116	S363RB-6	95	S646-S768AB-6-6	118	S762PMT-3	94	S768PMT-8-8	94
S269AB-6-4	116	S363RB-6S	95	S661	118	S762PMT-4	94	S769AB-4-2	98
S269AB-6-6	116	S363RB-8	95	S661L	118	S762PMT-6	94	S769AB-4-4	98
S269AB-6-8	116	S363RB-8S	95	S664	118	S762PMT-8	94	S769AB-4-6	98
S269AB-8-4	116	S366RBSV-634	95	S682-4-4	108	S762PMT-532	94	S769AB-6-2	98
S269AB-8-6	116	S366RBSV-878	95	S682-4-5	108	S762PMTBH-2	94	S769AB-6-4	98
S269AB-8-8	116	S368AB-6-4	96	S682-6-5	108	S762PMTBH-4	94	S769AB-6-6	98
S269AB-10-6	116	S368AB-6-4-1	96	S682-6-6	108	S762PMTBH-6	94	S769AB-6-8	98
S269AB-10-8	116	S368AB-6-6	96	S682-6-8	108	S762PMTBH-8	94	S769AB-8-4	98
S269PMT-4-2	92	S368AB-6-6-1	96	S682-8-8	108	S763AB-4	97	S769AB-8-6	98
S269PMT-4-4	92	S368AB-6-8	96	S682-10-8	108	S763AB-6	97	S769AB-8-8	98
S269PMT-4-6	92	S368AB-6-8-1	96	S682-10-10	108	S763AB-8	97	S769AB-10-6	98
S269PMT-6-2	92	S368AB-8-6	96	S682-12-10	108	S763AB-10	97	S769AB-10-8	98
S269PMT-6-4	92	S368AB-8-6-1	96	S684-5-6	108	S763AB-12	97	S769AB-12-8	98
S269PMT-6-6	92	S368AB-8-8	96	S684-6-6	108	S764AB-4	97	S769AB-12-12	98
S269PMT-6-8	92	S368AB-8-8-1	96	S684-12-12	108	S764AB-6	97	S769PMT-2-2	94
S269PMT-8-4	92	S371ABS-6	96	S688-6-6	108	S764AB-8	97	S769PMT-2-4	94
S269PMT-8-6	92	S371ABS-8	96	S688-12-12	108	S764AB-10	97	S769PMT-4-2	94
S269PMT-8-8	92	S371AS-6	96	S689	118	S764PMT-2	94	S769PMT-4-4	94
S269PMT-12-8	92	S371AS-8	96	S690-4-3	108	S764PMT-3	94	S769PMT-4-6	94
S269PMT-12-12	92	S376AB-3/4-4	96	S690-4-4	108	S764PMT-4	94	S769PMT-6-2	94
S269PMTNS-4-2	92	S376AB-3/4-6	96	S690-5-4	108	S764PMT-6	94	S769PMT-6-4	94
S269PMTNS-4-4	92	S376AB-3/4-8	96	S690-5-5	108	S764PMT-8	94	S769PMT-6-6	94
S269PMTNS-6-4	92	S376AB-7/8-6	96	S690-5-6	108	S764PMT-532	94	S769PMT-6-8	94
S269PMTNS-6-6	92	S376AB-7/8-8	96	S690-6-5	108	S765AB-4	97	S769PMT-8-4	94
S269PMTNS-8-6	92	S378AB-6-4	96	S690-6-6	108	S765AB-6	97	S769PMT-8-6	94
S269PMTNS-8-8	92	S378AB-6-6	96	S690-8-8	108	S765AB-8	97	S769PMT-8-8	94
S270AB-6-4	117	S378AB-6-8	96	S690-10-10	108	S765AB-10	97	S770AB-4-2	98
S270AB-6-6	117	S378AB-8-6	96	S692-4-3	109	S766AB-4-2	97	S770AB-4-4	98
S270AB-8-6	117	S378AB-8-8	96	S692-4-4	109	S766AB-4-4	97	S770AB-6-4	98
S270PMTNS-4-2	93	S600	118	S692-4-5	109	S766AB-6-2	97	S770AB-6-6	98
S270PMTNS-4-4	93	S600L	118	S692-6-5	109	S766AB-6-4	97	S770AB-8-6	98
S270PMTNS-6-4	93	S607	118	S692-6-6	109	S766AB-6-6	97	S770AB-8-8	98
S271AB-6-4	117	S608	118	S692-8-8	109	S766AB-8-6	97	S770AB-10-8	98
S271AB-6-6	117	S609	118	S694-4-3	109	S766AB-8-8	97	S771AB-4-2	98
S271AB-8-6	117	S611	118	S694-4-4	109	S766AB-10-6	97	S771AB-4-4	98
S271PMT-4-2	93	S612	118	S694-4-5	109	S766AB-10-8	97	S771AB-6-4	98
S271PMT-4-4	93	S613	118	S694-6-6	109	S768AB-4-2	97	S771AB-6-6	98
S271PMT-6-4	93	S615	118	S694-8-8	109	S768AB-4-4	97	S771AB-8-6	98
S271PMT-6-6	93	S620	118	S694-10-10	109	S768AB-4-6	97	S771AB-8-8	98
S271PMT-8-6	93	S620V	118	S696-4	109	S768AB-6-2	97	S771AB-10-8	98
S271PMT-8-8	93	S625-4-2	108	S696-5	109	S768AB-6-4	97	S772AB-4-2	98
S272AB-6-2	117	S625-4-4	108	S696-6	109	S768AB-6-6	97	S772AB-4-4	98
S272AB-6-4	117	S625-4-6	108	S696-8	109	S768AB-6-8	97	S772AB-6-2	98
S272AB-6-6	117	S625-5-2	108	S754PMT-4-2	94	S768AB-8-4	97	S772AB-6-4	98
S272AB-8-6	117	S625-5-4	108	S754PMT-4-4	94	S768AB-8-6	97	S772AB-6-6	98
S272PMT-4-2	93	S625-6-2	108	S754PMT-4-6	94	S768AB-8-8	97	S772AB-8-4	98
S272PMT-4-4	93	S625-6-4	108	S754PMT-6-4	94	S768AB-8-12	97	S772AB-8-6	98



Part Number	Page Number	Part Number	Page Number	Part Number	Page Number	Part Number	Page Number	Part Number	Page Number
S772AB-8-8	98	SPPH-4	105						
S772AB-10-8	98	SPPH-6	105						
S772PMT-2-2	94	SPPH-8	105						
S772PMT-2-4	94	SPPH-12	105						
S772PMT-4-2	94	SPRB-4-2	105						
S772PMT-4-4	94	SPRB-6-2	105						
S772PMT-6-4	94	SPRB-6-4	105						
S772PMT-6-6	94	SPRB-8-2	105						
S772PMT-8-6	94	SPRB-8-4	105						
S774AB-4	98	SPRB-8-6	105						
S774AB-6	98	SPRB-12-2	105						
S774AB-8	98	SPRB-12-4	105						
S779AB-4-2	98	SPRB-12-6	105						
S779AB-4-4	98	SPRB-12-8	105						
S779AB-6-2	98	SPRB-16-12	105						
S779AB-6-4	98	ST5-6-8	115						
S779AB-6-6	98	SV401-2	88						
S779AB-6-8	98	SV401-4	88						
S779AB-8-4	98	SV401-6	88						
S779AB-8-6	98	SV402-2	88						
S779AB-8-8	98	SV402-4	88						
S779AB-10-6	98	SV402-6	88						
S779AB-10-8	98	SV404P-6-6	89						
S807	118	SV404P-10-6	89						
SCT1-6-2	99	SV404P-10-8	89						
SDC603-4	87	SV404P-12-6	89						
SDC604-2	87	SV404P-12-8	89						
SDC604-4	87	SV404PH-6-6	89						
SDC604-6	87	SV404PH-10-6	89						
SFB-3	115	SV405P-6-6	89						
SFB-4	115	SV405P-8-8	89						
SFB-5	115	SV406P-4	90						
SFB-6	115	SV406P-6	90						
SFB-8	115	SV407P-4	90						
SFB-10	115	SV407P-6	90						
SFB-12	115	SV500P-4	90						
SFF209-2	88	SV500P-6	90						
SFF209-4	88	SV500P-8	90						
SFF209-6	88	SV590PH-6	89						
SFF209-8	88	SV590PH-8	89						
SFFX1-6-8	115	SV601-2	88						
SFFX1-8-8	115	SV601-4	88						
SFG-3	115	SV601-6	88						
SFG-4	115	SV601-8	88						
SFG-5	115	SVC206-4-2	88						
SFG-6	115	SVC206-4-4	88						
SFG-8	115	SVC206-6-4	88						
SFG-10	115	SVC406P-4	90						
SFG-12	115	SVC406P-6	90						
SHBT1-6-6-4	107	SVC407P-4	90						
SHBT2-6	107	SVC407P-6	90						
SOVF45-6-8	89								
SOVF45-6-12	89								
SPHN-2	105								
SPHN-4	105								
SPHN-4-2	105								
SPHN-6	105								
SPHN-6-2	105								
SPHN-6-4	105								
SPHN-8	105								
SPHN-8-4	105								
SPHN-8-6	105								
SPHN-12	105								
SPHN-12-8	105								
SPPH-2	105								

# Abbreviations

ABS .....	Anti-Lock Brake System	NPTS .....	National Pipe Taper Straight
AG .....	Agricultural	NPSM .....	National Pipe Straight Mechanical
AMP .....	Amperage	OD .....	Outside Diameter
AMS .....	Aerospace Material Specification	OEM .....	Original Equipment Manufacturer
APP .....	Application	OSHA .....	Occupational Safety and Health Administration
APPL .....	Apply	OZ .....	Ounce
AWG .....	American Wire Gauge	PCS .....	Pieces
ASTM .....	American Society of Testing Materials	POP .....	Point Of Purchase
BK .....	Black	PRESS .....	Pressure
BL .....	Blue	PSI .....	Pounds Per Square Inch
BN .....	Brown	PSIG .....	Pounds Per Square Inch Gauge
C .....	Celsius	PVC .....	Poly Vinyl Chloride
CAP .....	Capacity	R .....	Red
CFM .....	Cubic Feet Per Minute	REC .....	Recovered
CONT'D .....	Continued	REL .....	Release
CONV .....	Conventional	RH .....	Right Hand
CSA .....	Canadian Standards Association	RT .....	Right Taillamp
DIA .....	Diameter	RV .....	Recreational Vehicle
DOT .....	Department Of Transportation	SAE .....	Society Of Automotive Engineers
ETP .....	Electro Tough Pitch	SPEC .....	Specification
EXC .....	Except	STP .....	Stamped
EXP .....	Expanded	THERM .....	Thermostat
F .....	Fahrenheit	TEMP .....	Temperature
FIP .....	Female Iron Pipe	TMC .....	Technology Maintenance Council
FPT .....	Female Pipe Thread	UL .....	Underwriters Laboratories
FR .....	Flame Retardant	UN .....	United National
FT .....	Foot	UNC .....	Unified National Coarse
FQA .....	Fastener Quality Act	UNF .....	Unified National Fine
GA .....	Gauge	UNS .....	Unified National Special
GN .....	Green	UV .....	Ultra Violet
GRV .....	Groove	W .....	White
HSG .....	Housing	Y .....	Yellow
I D .....	Inside Diameter		
IL .....	In-line		
IMP .....	Impeller		
LBS .....	Pounds		
LH .....	Left Hand		
LT .....	Left Taillamp		
MAX .....	Maximum		
MCM .....	One Thousand Circular Mills		
MIL .....	Military		
MIP .....	Male Iron Pipe		
MNT .....	Mount		
MPT .....	Male Pipe Thread		
NEMA .....	National Electronics Manufacturers Association		
NO .....	Number		
NOM .....	Nominal		
NPT .....	National Pipe Taper		
NPTF .....	National Pipe Taper Fuel		

## Plumbing Diagrams

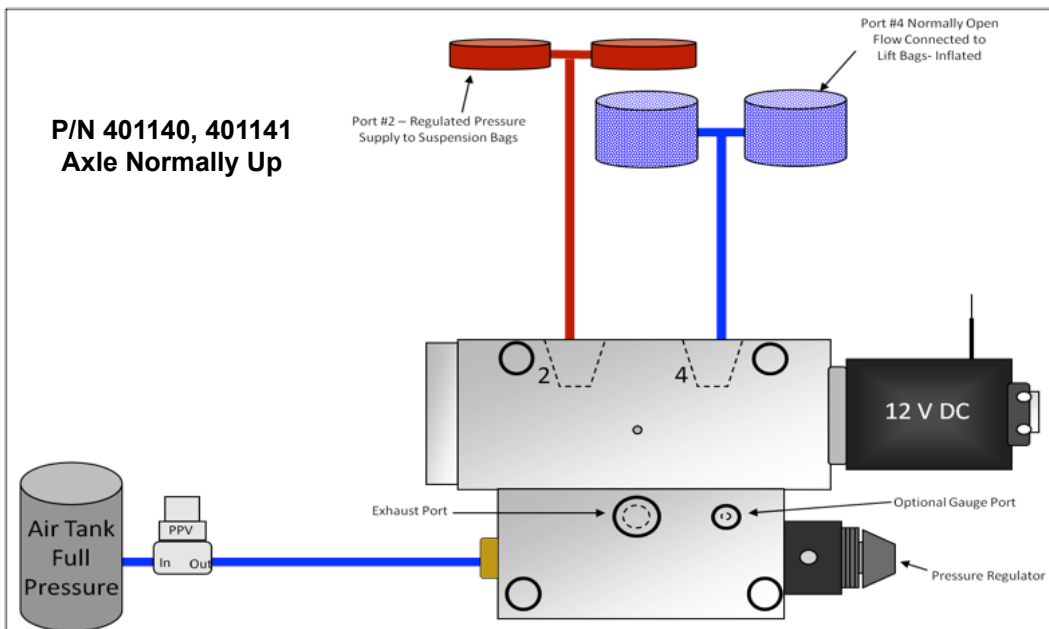
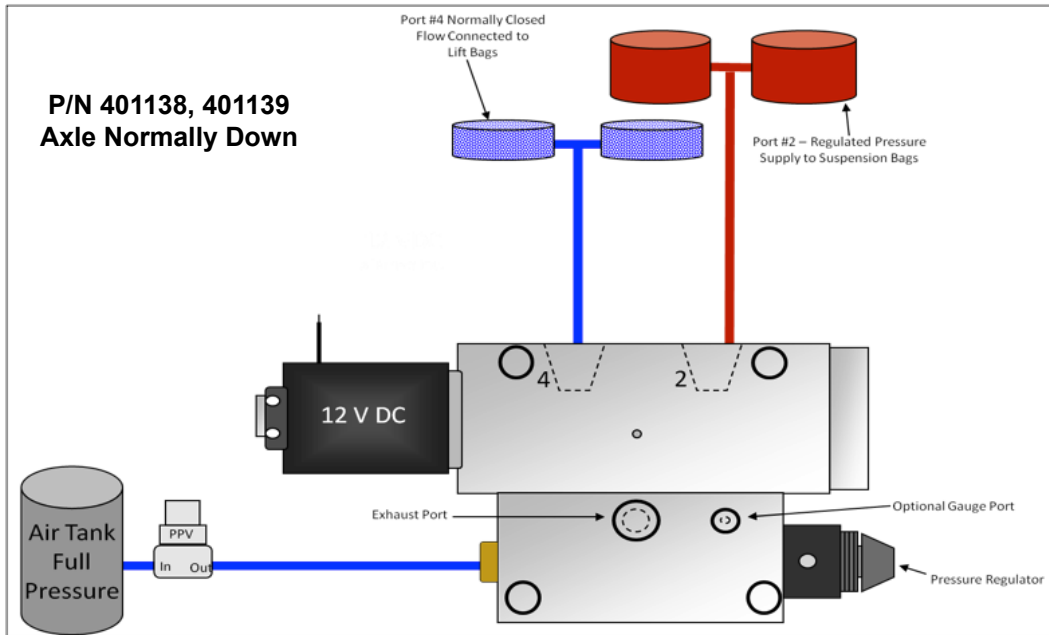

# Notes

P/N 401263

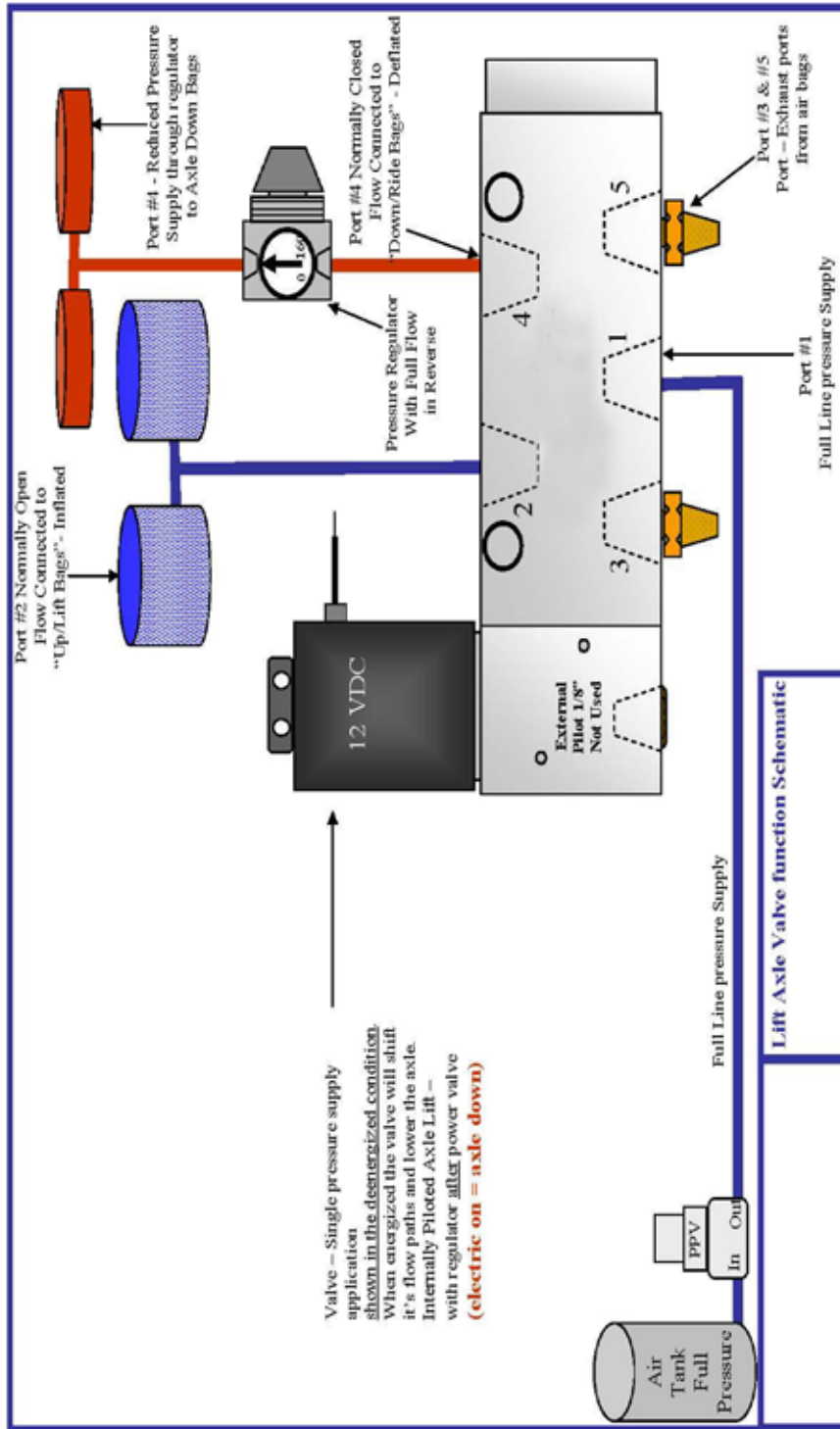



# TRAMEC SLOAN

## PARTNERING WITH HEAVY DUTY FOR OVER 35 YEARS

### For Quality, Selection, and Service, TRAMEC SLOAN Delivers!

#### **AIR COMPONENTS**

- GLADHANDS
- COILED AIR ASSEMBLIES
- BRASS FITTINGS
- AIR VALVES
- RUBBER HOSE ASSEMBLIES
- 3-IN-1 & 4-IN-1 WRAPS
- QUICK-FIX®
- DURA-GRIP™
- MAXXGRIP®
- AIR TANKS
- AIR CYLINDERS
- MAXXDUTY® HOSE ASSEMBLIES
- AIR CYLINDERS

#### **ELECTRIC COMPONENTS**

- BULK WIRE AND CABLE
- PLUGS AND SOCKETS
- ELECTRICAL CONNECTORS
- BATTERY TERMINALS
- SWITCHES AND TOGGLES
- USA HARNESS SYSTEMS

#### **TRACTOR COMPONENTS**

- WATER PUMPS
- MICHELIN WIPER BLADES
- LOCKING FUEL CAPS
- OIL DIPSTICKS AND FILLER CAPS
- HOTSTART ENGINE HEATERS

GALION, OH  
HOLLAND, MI  
IOLA, KS

Catalog no. 1700N (supersedes catalog no. 1700M)

534 East 48<sup>th</sup> Street, Holland, MI 49423  
Fax: 877-286-6515

TRAMECSLOAN.COM

1.800.336.7778